



This is a digital copy of a book that was preserved for generations on library shelves before it was carefully scanned by Google as part of a project to make the world's books discoverable online.

It has survived long enough for the copyright to expire and the book to enter the public domain. A public domain book is one that was never subject to copyright or whose legal copyright term has expired. Whether a book is in the public domain may vary country to country. Public domain books are our gateways to the past, representing a wealth of history, culture and knowledge that's often difficult to discover.

Marks, notations and other marginalia present in the original volume will appear in this file - a reminder of this book's long journey from the publisher to a library and finally to you.

Usage guidelines

Google is proud to partner with libraries to digitize public domain materials and make them widely accessible. Public domain books belong to the public and we are merely their custodians. Nevertheless, this work is expensive, so in order to keep providing this resource, we have taken steps to prevent abuse by commercial parties, including placing technical restrictions on automated querying.

We also ask that you:

- + *Make non-commercial use of the files* We designed Google Book Search for use by individuals, and we request that you use these files for personal, non-commercial purposes.
- + *Refrain from automated querying* Do not send automated queries of any sort to Google's system: If you are conducting research on machine translation, optical character recognition or other areas where access to a large amount of text is helpful, please contact us. We encourage the use of public domain materials for these purposes and may be able to help.
- + *Maintain attribution* The Google "watermark" you see on each file is essential for informing people about this project and helping them find additional materials through Google Book Search. Please do not remove it.
- + *Keep it legal* Whatever your use, remember that you are responsible for ensuring that what you are doing is legal. Do not assume that just because we believe a book is in the public domain for users in the United States, that the work is also in the public domain for users in other countries. Whether a book is still in copyright varies from country to country, and we can't offer guidance on whether any specific use of any specific book is allowed. Please do not assume that a book's appearance in Google Book Search means it can be used in any manner anywhere in the world. Copyright infringement liability can be quite severe.

About Google Book Search

Google's mission is to organize the world's information and to make it universally accessible and useful. Google Book Search helps readers discover the world's books while helping authors and publishers reach new audiences. You can search through the full text of this book on the web at <http://books.google.com/>



BERKELEY
LIBRARY
UNIVERSITY OF
CALIFORNIA

*Library
School
Library*

MANUAL
OF
LIBRARY ECONOMY

BY
JAMES DUFF BROWN

BOROUGH LIBRARIAN, FINSBURY, LONDON

AUTHOR OF "MANUAL OF LIBRARY CLASSIFICATION," "BIOGRAPHICAL DICTIONARY OF
MUSICIANS," ETC.

WITH 169 ILLUSTRATIONS, FORMS, ETC.

LONDON
SCOTT, GREENWOOD & CO.
19 LUDGATE HILL, E.C.

1903

[All rights reserved]

*[Any profits arising from the sale of
this book will be handed over to the
Library Association.]*

Lib. School Lib.

GIFT

Z670
B8
1903
Library
Sch. vol.

PREFACE.

THIS work is an attempt to provide a text-book of advanced library practice, on more comprehensive lines than anything of the kind yet published in English. There is no single work on modern library economy which gives a general account of the principal methods which have survived the test of continuous and wide-spread trial, nor one which considers these methods and principles as affected by the rate limitation imposed by the Public Libraries Acts.

Librarianship in Britain has suffered to some extent from the lack of anything in the way of classification of its essential elements, and it differs from most other sciences in having no generally recognised series of established facts to form a basis on which to erect a properly developed science of library economy. Perhaps it is fortunate that British library practice has progressed on freely experimental lines, allowing for improvements and readjustment at any point, as it will thus avoid all risk of becoming stereotyped, or running into grooves which may tend to check the growth of original ideas. The hampering effects of too much uniformity are to be seen in full operation in France and the United States. In the former, a government bureau has ordained that the communal libraries shall be organised according to a narrow and very elementary code of rules, drawn up nearly twenty years ago, in which every detail of library management is

PREFACE.

made the subject of a cut-and-dried ordinance. Naturally, this effectually stifles improvement and produces a monotonous uniformity which rejoices the official mind without, however, attracting or satisfying the public.

In the United States a much higher level of attainment has been reached, but here again the paralysing hand of uniformity has arrested progress after a certain standard of efficiency has become general. American libraries are conducted on lines which closely resemble those of ordinary commercial practice, in which everything is subordinated to the furtherance of profits and economy. Their methods are standardised, and everything is more or less interchangeable, with the result that in America we witness practically the same phenomenon as in conservative France. Where methods are run on codified lines, there is always this danger of everything becoming fixed, and all the advantages arising from adjustability and the power of revision being lost in the unprofitable pursuit of the unalterable. In British libraries most methods have been in a state of flux for fifty years, and there is little immediate danger of any process crystallising into a fixed and unalterable condition. For this state of things we have to thank our freedom from too much State interference, and the comparative absence of commercial syndicates which profess to supply libraries and librarians ready made. The only fixed principle from which British libraries suffer is the rate which may be levied for library purposes, and for this our Government is entirely responsible, having been smitten for once with the French bureaucratic craze for a mediocre uniformity.

This manual does not attempt to record all the conventions and traditions of the older librarianship, nor does it pretend to describe all the ideas and methods of modern librarianship. It endeavours to collect and summarise some of the best and most vital methods which have been

PREFACE.

adopted, and to arrange them in such divisions as may tend to give the book a systematic form, and so place the study of library economy on a more consistent and scientific basis than heretofore. For the first time, too, an effort is made to consider questions connected with buildings, finance, books, etc., from the standpoint of the limitation of the Library Rate. This brings out in full relief the crippling influence of the plan of financial restriction placed upon every department of British library work by Parliamentary limitations, and shows the difficulty of further developments and improvements in library equipment and practice, without additional means.

In a text-book such as this, dealing mainly with broad principles, it has not been thought desirable to notice every detail of library routine work, nor to mention every appliance which has been introduced. To do so thoroughly would extend this manual to many times its present size. Nevertheless, the work gives an adequate view of every department of modern librarianship, and, in addition, provides hundreds of references to periodical and other literature, from which further information may be gathered.

I am deeply indebted to Mr. Thomas Greenwood for encouragement and aid in the preparation of this work. But for his active assistance and sympathy it would never have been published. The publication of works on libraries has at all times been unprofitable, and very few private publishers will undertake the risk of issuing text-books which only sell in very limited numbers.

Many librarians have assisted in the preparation of this manual, by their writings and suggestions, but I may name Messrs. L. S. Jast (Croydon Public Libraries) and Franklin T. Barrett (Fulham Public Libraries) as having been specially helpful in giving valuable aid and advice. They both read the proofs, making many good suggestions in the process, and Mr. Barrett also supplied some of the

PREFACE.

photographs and drawings with which the work is illustrated. To the editors and proprietors of *The Library* and *The Library World* I am also indebted for some of the material used in various parts of this manual, and there are others, too numerous for mention, who have given suggestions towards the compilation of the work.

JAMES DUFF BROWN.

CLERKENWELL PUBLIC LIBRARY,
FINSBURY, LONDON,
May, 1903.

CONTENTS.

| | PAGE |
|--|------|
| PREFACE | iii |
| LIST OF ILLUSTRATIONS, FORMS, ETC. | ix |

DIVISION I.—FOUNDATION AND COMMITTEES.

| | | |
|---------|---|----|
| CHAPTER | I. LEGISLATION. (Sections 1-15) | 1 |
| " | II. ADOPTION OF ACTS AND FOUNDATION. (Sections 16-21) | 11 |
| " | III. COMMITTEES. (Sections 22-32) | 14 |
| " | IV. FINANCE, LOANS, ACCOUNTS, REPORTS. (Sections 33-67) | 24 |

DIVISION II.—STAFF.

| | | |
|---------|---|----|
| CHAPTER | V. LIBRARIAN. (Sections 68-89) | 53 |
| " | VI. ASSISTANTS. (Sections 90-109) | 72 |

DIVISION III.—BUILDINGS.

| | | |
|---------|--|-----|
| CHAPTER | VII. THEORY AND GENERAL REMARKS. (Sections 110-116) | 90 |
| " | VIII. SITES AND PLANS. (Sections 117-130) | 95 |
| " | IX. HEATING, LIGHTING, VENTILATION, CLEANING. (Sections 131-139) | 106 |
| " | X. DETAILS OF ACCOMMODATION. (Sections 140-156) | 113 |

DIVISION IV.—FITTINGS AND FURNITURE.

| | | |
|---------|--|-----|
| CHAPTER | XI. MISCELLANEOUS FIXTURES AND FITTINGS. (Sections 157-174) | 122 |
| " | XII. SHELVING AND ACCESSORIES. (Sections 175-200) | 137 |
| " | XIII. LIBRARY INDICATORS. (Sections 201-216) | 160 |
| " | XIV. FURNITURE. (Sections 217-236) | 178 |
| " | XV. CHARGING, FILING, REGISTRATION AND COPYING APPARATUS. (Sections 237-250) | 195 |

CONTENTS.

| | PAGE |
|--|------|
| DIVISION V.—BOOK SELECTION AND ACCESSION. | |
| CHAPTER XVI. BOOK SELECTION. (Sections 251-285) . . . | 201 |
| „ XVII. ACCESSION METHODS. (Sections 286-304) . . . | 230 |
| DIVISION VI.—CLASSIFICATION AND SHELF ARRANGEMENT. | |
| CHAPTER XVIII. GENERAL PRINCIPLES. (Sections 305-310) . . . | 244 |
| „ XIX. SYSTEMATIC CLASSIFICATION SCHEMES. (Sections 311-317) . . . | 254 |
| „ XX. PRACTICAL APPLICATION. (Sections 318-325) . . . | 265 |
| DIVISION VII.—CATALOGUING, INDEXING, FILING. | |
| CHAPTER XXI. CATALOGUING RULES AND METHODS. (Sections 326-331) . . . | 273 |
| „ XXII. PRINTED CATALOGUES. (Sections 332-343) . . . | 285 |
| „ XXIII. MECHANICAL METHODS OF DISPLAYING CATALOGUES. (Sections 344-366) . . . | 295 |
| „ XXIV. INDEXING AND FILING. (Sections 367-379) . . . | 315 |
| DIVISION VIII.—MAINTENANCE AND ROUTINE WORK. | |
| CHAPTER XXV. STATIONERY AND RECORDS. (Sections 380-385) . . . | 323 |
| „ XXVI. BOOKBINDING AND REPAIRING. (Sections 386-405) . . . | 328 |
| DIVISION IX.—PUBLIC SERVICE. | |
| CHAPTER XXVII. RULES AND REGULATIONS. (Sections 406-421) . . . | 349 |
| „ XXVIII. REGISTRATION OF BORROWERS. (Sections 422-430) . . . | 370 |
| „ XXIX. ISSUE METHODS. (Sections 431-447) . . . | 379 |
| „ XXX. BOOK DISTRIBUTION. (Sections 448-463) . . . | 405 |
| „ XXXI. REFERENCE LIBRARIES. (Sections 464-474) . . . | 418 |
| „ XXXII. READING ROOM METHODS AND SUBSIDIARY DEPARTMENTS. (Sections 475-501) . . . | 427 |
| „ XXXIII. PUBLIC ACCESS TO LIBRARY SHELVES. (Sections 502-527) . . . | 445 |
| INDEX | 469 |

LIST OF ILLUSTRATIONS, FORMS, ETC.

| FIG. | PAGE | FIG. | PAGE |
|---|------|--|------|
| 1. Minute Book Ruling | 19 | 23. Elevation and Section of Reference Library Barrier | 123. |
| 2. Summons to Committee Meetings | 20 | 24. Open-Access Library Counter (Fulham) | 124 |
| 3. Committee Attendance Register | 22 | 25. Single Open-Access Barrier | 125. |
| 4. Cash Book Ruling | 31 | 26. Triple Open-Access Barrier | 125 |
| 5. Accounts Ledger Ruling | 33 | 27. Treadle Latch for Open-Access Wicket | 126. |
| 6. Petty Cash Book Ruling | 34 | 28. Iron Barrier for dividing Room | 127 |
| 7. Cash Receipts Book Ruling | 35 | 29. Double Newspaper Stand (View) | 128. |
| 8. Postage Book Ruling | 37 | 30. Double Newspaper Stand (Elevation) | 128 |
| 9. Monthly Salaries Sheet | 38 | 31. Wall Newspaper Slope (View) | 129. |
| 10. Receipt Form | 39 | 32. Wall Newspaper Slope (Elevation) | 130. |
| 11. Budget, or Table of Expenditures | 43 | 33. Double Newspaper Stand (Elevation) | 181 |
| 12. Suggestion Slip | 50 | 34. Simplex Newspaper Holder | 182 |
| 13. Staff Work Book | 76 | 35. Revolving Newspaper Holder | 182 |
| 14. Staff Orderly Board | 79 | 36. Periodical Easel with Revolving Holder | 183 |
| 15. Staff Time Card | 82 | 37. Standard Iron Bookcase | 139. |
| 16. Sketch Plan of Library on One Floor | 101 | 38. Wooden Wall Case | 140. |
| 17. Sketch Plan of Lending Library with Indicator | 102 | 39. Tonks' Shelf Fittings | 141 |
| 18. Sketch Plan of Lending Library with Indicator (Fiction) | 102 | 40. Details of Lambert's Shelving | 142. |
| 19. Sketch Plan of Library on Two Floors (Ground) | 103 | | |
| 20. Sketch Plan of Library on Two Floors (First) | 103 | | |
| 21. Newsroom with Wall Slopes (Fulham) | 115 | | |
| 22. Back of Library Counter | 123 | | |

LIST OF ILLUSTRATIONS, FORMS, ETC.

| FIG. | PAGE | FIG. | PAGE |
|---|------|---|------|
| 41. Adjustable Metal Shelving (Patent Office) . . . | 148 | 78. British Museum Reading Table . . . | 180 |
| 42. Smith's Adjustable Shelving . . . | 144 | 74. Cornell University Reading Tables . . . | 181 |
| 43. Rack for Bound Newspapers . . . | 145 | 75. Students' Reading Table . | 182 |
| 44. Case for Large Folio Books . . . | 146 | 76. Periodical Rack (Elevated) | 183 |
| 45. Convertible Table Bookcase . . . | 147 | 77. Periodical Rack on Table-Top . . . | 184 |
| 46. Lattice-Work Steps . . . | 149 | 78. Table Rack for Periodicals | 184 |
| 47. Short Steps for Low Shelves . . . | 149 | 79. Kensington Periodical Rack | 185 |
| 48. Continuous Wooden Step and Handles . . . | 150 | 80. Cotgreave Periodical Rack | 186 |
| 49. Automatic Closing Step . | 151 | 81. Rack for Odd Periodicals . | 187 |
| 50. Adjustable Closing Step . | 151 | 82. Railway Time-Table Rack . | 188 |
| 51. Swinging Step and Improved Handle . . . | 152 | 83. Metal Reading Easel . . . | 189 |
| 52. Block Shelf Dummy . . . | 153 | 84. Wooden Reading Easel . . . | 189 |
| 53. Millboard Shelf Dummy . | 154 | 85. Columbia Dictionary Holder . . . | 190 |
| 54. Flanged Label Holder . . | 154 | 86. Chair with Anchorage . . . | 191 |
| 55. Label Holder with Tongue | 155 | 87. Arm Chair with Hat Rail . | 192 |
| 56. Xylonite Label-Holder . . | 155 | 88. Chair with Folding Tray . | 193 |
| 57. Tongued Metal Book-Rest | 155 | 89. Card Charging Tray . . . | 195 |
| 58. Flanged Metal Book-Rest . | 156 | 90. Guide for Tray . . . | 196 |
| 59. Combined Book-Rest and Shelf Guide . . . | 156 | 91. Card-Sorting Tray . . . | 197 |
| 60. Yale Book-Rest . . . | 157 | 92. Pamphlet Box . . . | 198 |
| 61. Adjustable Book-Stand . . | 157 | 93. Donation Acknowledgment Form . . . | 231 |
| 62. Adjustable Book-Carrier . | 158 | 94. Donation Book Ruling . . . | 231 |
| 63. Book Truck . . . | 158 | 95. Proposition Book Ruling . | 232 |
| 64. Dent Indicator . . . | 164 | 96. Book Order Sheet . . . | 234 |
| 65. Elliot Indicator . . . | 165 | 97. Book Order Tray . . . | 235 |
| 66. Ticket for Kennedy Indicator . . . | 167 | 98. Accessions Routine Book . | 236 |
| 67. Kennedy Indicator . . . | 168 | 99. Accessions Number Book . | 235 |
| 68. Ticket for Morgan Indicator . . . | 171 | 100. Book Card . . . | 237 |
| 69. Cotgreave Indicator . . . | 172 | 101. Book Issue Label . . . | 238 |
| 70. Chivers' Indicator . . . | 174 | 102. Stock Book Ruling . . . | 240 |
| 71. Periodicals Indicator . . . | 176 | 103. Stock Book Ruling . . . | 240 |
| 72. Desk-Topped Table . . . | 179 | 104. Abstract Sheet for Stock Book . . . | 241 |
| | | 105. Withdrawals Book . . . | 242 |
| | | 106. Lettering of Book Numbers . . . | 265 |
| | | 107. Book Marking . . . | 266 |
| | | 108. Tier Marking of Books . . | 268 |

LIST OF ILLUSTRATIONS, FORMS, ETC.

| FIG. | PAGE | FIG. | PAGE |
|--|---------|---|------|
| 109. Shelf Front with Labels | 270 | 137. Binding Sheet | 342 |
| 110. Class Guide | 270 | 138. Binding Order Slip | 343 |
| 111. Shelf Check Register | 271 | 139. Book-Mark | 345 |
| 112. Section of Catalogue Shelves (British Museum) | 296 | 140. Renewal Slip | 366 |
| 113. Adjustable Screw Binder | 297 | 141. Voucher for a Ratepayer | 371 |
| 114. Rudolph Indexer Book | 298 | 142. Voucher for a Non-Rate- payer (Front) | 372 |
| 115. Card Catalogue Cabinet | 300 | 143. Voucher for a Non-Rate- payer (Back) | 372 |
| 116. Cabinet of Card Trays | 301 | 144. Borrower's Cards | 374 |
| 117. Cards for Bonnange Trays | 303 | 145. Borrowers' Number Re- gister | 376 |
| 118. Bonnange Card Catalogue Trays | 304 | 146. Borrowers' Voucher Tray | 377 |
| 119. Staderini Cards and Cata- logue Trays | 305 | 147. Issue Ledger | 384 |
| 120. Duplex Card Catalogue Tray | 306 | 148. Issue Day-Book | 385 |
| 121. Leyden Slip-Holder | 307 | 149. Condensed Issue Day-Book | 385 |
| 122. Staderini Sheaf Catalogue | 308 | 150. Borrowers' Ledger | 387 |
| 123. Storage of Staderini Sheaf Catalogue | 308 | 151. Book Issue Ledger | 388 |
| 124. Sacconi Sheaf Catalogue (Fastening) | 309 | 152. Book Issue Slip | 390 |
| 125. Sacconi Sheaf Catalogue (Open) | 309 | 153. Call Slip | 391 |
| 126. Adjustable Sheaf Cata- logue (Clamp) | 310 | 154. Book Issue Card | 394 |
| 127. Adjustable Sheaf Cata- logue (Single Screw, Open) | 311 | 155. Virgo Pocket Ticket | 395 |
| 128. Adjustable Sheaf Cata- logue (Single Screw, Detached) | 311 | 156. Book-Card for Virgo System | 396 |
| 129. Adjustable Placard Cata- logue | 312 | 157. American Issue Pocket | 397 |
| 130. Rudolph Continuous In- dexer | 313 | 158. American Book-Card | 398 |
| 131. Rudolph Continuous In- dexer | 313 | 159. American Borrower's Card | 399 |
| 132. Supplies Location Card | 317 | 160. Schwartz Card and Pocket | 400 |
| 133. Box for Filing Prints | 321 | 161. Combined Book and Borrower's Card | 402 |
| 134. Periodical File | 322 | 162. Branch Library Return | 407 |
| 135. Inventory Book | 326 | 163. Issue Record Book (Left Side) | 415 |
| 136. Specimens of Class Letter- ing | 336-339 | 164. Issue Record Book (Right Side) | 416 |
| | | 165. Reference Application Form | 425 |
| | | 166. Adjustable Periodicals List | 433 |
| | | 167. Check Card for Monthly Periodicals | 435 |
| | | 168. Check Card for Weekly Periodicals | 435 |
| | | 169. Check Card for Daily Newspapers | 435 |



DIVISION I.

FOUNDATION AND COMMITTEES.

CHAPTER I.

LEGISLATION.

1. Municipal Libraries : Acts of Parliament.—The principal Acts of Parliament under which British public municipal libraries are now constituted consist of the following :—

IRELAND.

1855. "18 & 19 Vict., c. 40. An Act for further promoting the establishment of Free Public Libraries and Museums in Ireland." (The principal Act.)
1877. "40 & 41 Vict., c. 15. An Act to amend the Public Libraries Act (Ireland), 1855."
1894. "57 and 58 Vict., c. 38. An Act to amend the Public Libraries (Ireland) Acts."
1902. "The Public Libraries (Ireland) Amendment Act."
Gives power to District Councils to adopt the Acts, and empowers County Councils to make grants in aid of libraries.

SCOTLAND.

1887. "50 & 51 Vict., c. 42. An Act to amend and consolidate the Public Libraries (Scotland) Acts." (The principal Act.)
1894. "57 & 58 Vict., c. 20. An Act to amend the Public Libraries Consolidation (Scotland) Act 1887."
1899. "62 & 63 Vict., c. 5. An Act to amend the Public Libraries (Scotland) Acts."

ENGLAND AND WALES.

1892. "55 & 56 Vict., c. 53. An Act to consolidate and amend the law relating to Public Libraries." (The principal Act.)
1893. "56 Vict., c. 11. An Act to amend the Public Libraries Act, 1892."
1898. "61 & 62 Vict., c. 53. An Act to provide for the Punishment of Offences in Libraries."

1901. "1 Edw. 7. An Act to amend the Acts relating to Public Libraries, Museums and Gymnasiums, and to regulate the liability of managers of libraries to proceedings for libel."

[NOTE.—This Act does *not* deal with actions for libel. It was originally intended to do so, but the clauses were struck out of the bill, and the title escaped emendation.]

2. The whole of these are now in force, and they repeal all the former Acts dating from 1852, while incorporating some of their provisions. In addition to these general Acts, a considerable number of local Acts have been passed on behalf of various towns, which include provisions for the modification of the general Acts, chiefly in regard to removing the limitation of the rate, and for other purposes. Such powers are usually contained in improvement or tramway Acts, and the principal towns which have obtained them include Manchester, Birmingham, Glasgow, Edinburgh, Halifax, Darwen, Sheffield, Cardiff, etc. Several towns, like Brighton, Huddersfield, Kingston-on-Thames, have also special Acts which confer the power of establishing libraries, independently of the general Acts, so that the public libraries of Britain are not constituted under one general law.

3. The Public Library Law is further modified or extended by various other statutes which were passed for different purposes, and the principal Acts of this kind are as follows:—

"24 & 25 Vict., c. 97. An Act to consolidate and amend the Statute Law of England and Ireland relating to malicious injuries to property," 1861.

This gives power to prosecute for misdemeanour any person who unlawfully and maliciously destroys or damages any book, manuscript, etc., in any public museum, gallery, cabinet or library.

"56 & 57 Vict., c. 73. An Act to make further provision for local government in England and Wales," 1894.

Enables rural parishes to adopt the Public Libraries Act, 1892, by means of a parish meeting or poll of the voters in the parish.

"62 & 63 Vict., c. 14. An Act to make better provision for local government in London," 1899.

Confers the power of adopting the Public Libraries Act, 1892, on the Metropolitan Borough Councils, by extending to them the provisions of the Public Libraries Act, 1893.

The remaining statutes which in any way deal with public or private libraries will be noticed in connection with the departments of library administration to which they specifically refer, such as loans, rating, etc.

4. Main Provisions of the Municipal Libraries Acts.—A brief summary of the leading practical points in the various Acts will serve to give an idea of the powers which are conferred upon municipal authorities in regard to libraries :—

(a) **ADOPTION OF ACTS IN TOWNS.**—The Acts may be adopted in any city, county borough, burgh or urban district by a resolution passed by the council, at a special meeting of which a month's notice shall have been given, and the resolution must be advertised publicly in the usual way, and a copy sent to the Local Government Board, if the adoption is in England or Ireland; while a notice of the fact of adoption must also be sent.

(b) **ADOPTION OF ACTS IN PARISHES.**—In parishes in England and Scotland the Acts can only be adopted by a majority vote of the householders or voters.

(c) **LIBRARY RATE.**—A rate of one penny in the £ on the rateable value of an administrative area is the limit fixed by the Act, but power is given to parishes to fix a smaller sum by a popular vote, and to urban districts of all kinds to remove or fix any rate within the limit of one penny by resolution of the council.

(d) **POWERS.**—The Library Authority may provide public libraries, museums, schools for science, art galleries and schools for art, and for that purpose may purchase and hire land, and erect, take down, rebuild, alter, repair and extend buildings, and fit up, furnish and supply the same with all requisite furniture, fittings and conveniences. The Library Authority shall exercise the general management, regulation and control of every department established under the provisions of the Acts, and may provide books, newspapers, maps and specimens of art and science, and cause the same to be bound and repaired when necessary. Also appoint salaried officers and servants, and dismiss them, and make regulations for the safety and use of every library, museum, gallery and school under its control, and for the admission of the public thereto. Power is also given to make agreements with other library authorities for the joint use of library or other buildings; and to borrow money, with the sanction of the central authorities, for the purpose of buying sites, erecting buildings and furnishing them. The Irish Act of 1877 also gives power to establish schools of music as part of a library scheme.

The remaining powers and duties conferred by the various Public Libraries Acts are specified under the various heads of committees, accounts, etc., in subsequent sections of this work.

5. Municipal Libraries : Further Legislation Required.

—A very slight examination of the various Public Libraries Acts will suffice to show that they are urgently in need of amendment in several important directions. To begin with, it is quite evident that they are overloaded with powers to perform public educational work which cannot by any possibility be attempted with the limited funds which the Acts allow for the purpose. Ambitious library authorities who hope to establish a library, museum, art gallery and schools of science and art out of the proceeds of a penny rate, are laying themselves out for an enormous disappointment, and at the same time sacrificing the efficiency of the chief department—the library—and deceiving the public by providing only the mere shadow of the institutions which the Libraries Acts pretend can be established out of the penny rate. It is a hard enough task to provide a well-equipped library out of the very limited and inflexible income furnished by a penny rate, but it becomes much harder and even ridiculous to attempt to maintain museums, art galleries and classes out of the same meagre fund. The chief proof of this lies in the fact that very few library authorities have tried to provide museums or art galleries, and, where they have done so, it has been necessary to adopt the Museums Act, or apply to Parliament for special and extended rating powers. In some cases where museums have been established, and are maintained from the library rate, they are either neglected and useless collections of lumber, or else they are fostered at the expense of the library, which suffers greatly in consequence. Considering, then, that the Public Libraries Acts were passed for the chief purpose of enabling *libraries* to be established and maintained, and that separate legislation has been undertaken on behalf of museums and schools, it seems desirable as a first step towards amendment to free the Libraries Acts from all the overloading and complications arising from the provision of such additional departments. In this connection it should be borne in mind

that some of the provisions grafted on the Libraries Acts, for the purpose of enabling museums, etc., to be established conjointly, have been suggested by certain outside authorities who had either languishing art galleries or museums to bolster up at the expense of the library.

6. The principal amendment of the Libraries Acts, which authorities of all kinds now agree is essential and paramount to everything else, is the abolition or alteration of the RATE LIMITATION, which for fifty years has fettered the work of public libraries and in every way hindered their proper development. While public libraries were in an experimental stage, between 1850 and 1870, there was no doubt some justification for this caution, but at the present time, when the permissive character of the Bill has been changed, and the power of adoption transferred to the municipal authorities, it seems absurd to retain a limitation whose principal effect is to cripple the very institutions which the Acts were passed to foster. The great advance in the recognition which Parliament has extended to municipal undertakings within recent years forms a very strong argument in favour of amending the Libraries Acts in the direction of placing them on all fours, as regards the raising of necessary funds, with every other form of municipal enterprise. If no limitation is placed upon the rates which can be levied for baths and wash-houses, tramways, public health, lighting and education, it is surely an anomaly to retain on the Statute Book a restriction such as the fixing of the library rate, mainly, one supposes, because it was imposed about forty-seven years ago. But an anomaly even greater than this consists in the fact that certain towns have procured, by means of special legislation, power to override the rate limitation fixed by the general Act. Towns like Ashton-under-Lyne, Birmingham, Cardiff, Darwen, Halifax, Leicester, Manchester, Newcastle-on-Tyne, Oldham, Preston, Rochdale, St. Helens, Salford, Southport, Walsall, Wigan and Wolverhampton, which have gone to the trouble and expense of applying to Parliament for special rating facilities by means of local Acts, have the power of increasing their library rates from one penny to twopence and upwards. When this power has

been so extensively bestowed upon so many different kinds of municipalities, it seems absurd to withhold, by the general Act, from the equally important boroughs which have not applied to Parliament, the discretionary power of raising the library rate to suit local needs. In these enlightened days every community should have the right of spending on local educational institutions as much money as the wisdom of the municipal authority may grant, leaving it to the very healthy and active public opinion which exists everywhere to check unnecessary outlay, and criticise weak or improper administration. Failing the entire removal of the penny limit, it would be a great advantage if it could be raised to twopence.

7. Another serious blemish upon the existing Libraries Act is to be found in the absence of proper provisions for securing an adequate service of LIBRARIES IN RURAL DISTRICTS all over Britain, where they are so urgently required as an antidote to the monotony and isolation of country life. While any little Parish Council may adopt the Acts by a plebiscite of the rate-payers, in order to realise the magnificent library facilities which can be provided by a rate producing, perhaps, £20 per annum, County Councils are excluded from doing the work for the whole of a rural district on efficient, uniform and satisfactory lines. Amendment is badly wanted in the direction of empowering County Councils to establish and support complete systems of rural libraries, and the sooner this is done the better. It is mournful to witness the hopeless struggles of small rural councils to support little independent and inefficient village libraries on the pittance produced by a penny rate, which is barely sufficient in most cases to pay for rent and lighting. Amalgamation of several adjoining parishes is no solution of the difficulty, and most of the principal writers who have studied the question agree that efficiency in administration and provision can only be obtained by empowering the County Councils to undertake the work on behalf of the whole county; treating it as a unit and managing the whole system from one chief centre.

8. The provision of commodious and suitable LIBRARY BUILDINGS is a very serious problem in most places owing to the

limitation of the library rate. In many cases it is impossible to provide adequate accommodation and furniture without crippling the financial resources of the library, because of loans and their repayment. It is not made quite clear by the English Acts that repayments of the principal and interest of loans shall be made out of the library rate; while it is certainly clear that all the rates of a district may be mortgaged as security. Whatever may have been the intention of the framers of the English Acts, it is quite evident that, as most places repay the instalments of loans from the library rate, the possibility of making them a charge upon the general rate of the district has not been contemplated. If the limitation of the library rate is to be indefinitely maintained upon the Statute Book, it would be a great gain in every way if the Acts could be amended in the direction of enabling local authorities to erect library buildings out of the general rates, thus freeing the limited library rate for purely administrative purposes, and thereby greatly increasing the efficiency. Till some such course is adopted, as an alternative to removing the rate limitation entirely, public libraries cannot perform their functions efficiently and thoroughly, nor can they hope to rival the American public libraries in equipment and service.

9. Further legislation is desirable in the direction of enabling public libraries to co-operate more effectually with other educational bodies in the provision of improved facilities for study. At present School Boards, Technical Instruction Committees and similar bodies have no very clearly defined power to assist public libraries by making grants of money for the purchase of educational and technical literature. Effective co-operation among these bodies is thus rendered uncertain and difficult, while students and the general public suffer through considerable overlapping of effort. A clause in an Amendment Act, clearly laying down the extent and direction which the mutual provision by these authorities of educational literature should assume, would do much to smooth away difficulties and encourage more active and general co-operation. It would be a great advantage if the English and Irish Acts could be amended by the substitution of the provisions of the Scotch Act as regards

the constitution of committees and their powers, for the present unsatisfactory and permissive clauses.

10. **Non-Municipal Libraries : Acts of Parliament.**—The legislation affecting the large number of British libraries which are not supported out of the rates is neither extensive nor satisfactory. The chief feature of most of the Acts of Parliament which have been passed seems to be the benevolent one of granting certain facilities to various kinds of landowners to divest themselves of their property in order to provide sites for literary and scientific institutions! There are similar clauses in the Public Libraries Acts, and, of course, most of the Acts named apply to municipal libraries; but in reality this kind of legislation is not particularly valuable. To make the transfer of land for public purposes more easy is quite laudable, we admit, but it has not yet had the effect of inducing landowners to part with free plots of land as building sites, either to public library authorities or literary institutions.

11. The principal Act bearing on literary and scientific institutions is entitled "An Act to afford greater facilities for the establishment of Institutions for the promotion of Literature and Science and the Fine Arts, and to provide for their better regulation," 17 & 18 Vict., c. 112, 1854. This is nearly all taken up with provisions for transfers of lands and other property, and with a few regulations concerning members, rules, altering, extending or dissolving the institution, etc. This Act was afterwards to some extent modified by "An Act to facilitate the transfer of Schools for Science and Art to Local Authorities," 54 & 55 Vict., c. 61, 1891. These, and the other Acts referred to, which deal with transfers of property, have had very little to do with the development of voluntary literary and scientific institutions or libraries; the principal statute under which most of them are now governed being an Act passed primarily for quite a different purpose. This is the "Act to amend the 'Companies Act, 1862,'" 30 & 31 Vict., c. 131, 1867, under Section 23 of which power is given the Board of Trade to grant licenses to literary and similar associations, providing for registration with limited liability, and conferring all the privileges

attaching to limited companies. In connection with this Act, and those of 1862 and 1877, the Board of Trade has issued a series of circulars and forms which include draft rules, articles of association, etc. Under these licenses a considerable number of British literary institutions have been established and organised.

12. Colonial, American and Foreign Legislation.—In CANADA, AUSTRALIA and SOUTH AFRICA power is given the Government in each place to make grants in aid to public libraries, mechanics' institutes, schools of art, etc. These grants generally take the form of annual sums of money equal in value to the amount raised by the institutes or libraries by subscription. Thus, if a library raises £40 the Government will give other £40, and so on. There are several important municipal libraries in Canada, notably at Toronto and Hamilton, which are supported out of special local rates.

13. In the UNITED STATES most of the separate states in the Union have a special library law, under which towns are enabled to establish and maintain public libraries by means of a tax on the value of property. This differs very materially from the British law, which takes rental as the rateable value. In the United States the actual value of the properties is taken as the basis, with certain modifications, but the poundage, or amount of rate, is usually only a very small proportion of a dollar, instead of a fixed sum like one penny. It varies from about one-third of a mill to two mills on the dollar. Even with this modification, the total income produced by a rate of so many parts of a mill per dollar produces £55,000 in Boston, against £18,200, the annual produce of a 1½d. rate in Manchester, so great is the difference caused by the methods of valuation. Because of this liberal provision the number of public libraries in the United States is much greater than in Britain, while their equipment, stock of books and staff are generally superior, for the same reason.

14. No country in EUROPE has a library law like that in force in Britain and the United States, but a certain amount of recognition is accorded to public libraries by the State in most countries. Municipal libraries exist in France under State

direction, but very few towns in other countries have done much to foster public libraries in their midst. In some cases endowed or university or royal libraries are recognised or partly supported by the State or the municipal authorities, but so far no European nation has passed a general library law which gives communities direct control of the establishment, organisation and support of public libraries by means of a tax or rate.

15. REFERENCE LIST OF AUTHORITIES :—

- Chambers (G. F.) and H. W. Fovargue. *The Law relating to Public Libraries and Museums, etc.* Fourth edition. 1899. (This is the best and most comprehensive work on the subject.)
- Fovargue (H. W.) and J. J. Ogle. *Public Library Legislation.* (L. A. Series, No. 2.) 1893. (Has some historical value.)
- The Library Rate.* Symposium on Limitation. L. W., 1898, pp. 69, 109, 181.
- The Library Rate.* (Arguments in favour of the removal of the limitation.) Greenwood's Year Book, 1900, p. 5.
- Ballinger (J.) *The Rate limitation.* L. A. R., v. 5, p. 16.
- Credland, W. R. *County Councils and village libraries.* L. A. R., v. 1, p. 763.
- Greenwood, T. *Case for rural public libraries.* See his "Public Libraries," 1894, p. 438. See also "Travelling Libraries," Sections 455 and 463.
- Boosé, J. R. *Constitution of colonial public libraries.* L., v. 6, p. 391.
- Solberg, T. *Library Legislation (American).* Lib. J., Conf. no., p. 50.
- For list of abbreviations see Section 88.*

CHAPTER II.

ADOPTION OF ACTS AND FOUNDATION.

16. Methods of Adopting the Public Libraries Acts.—

There are only two methods prescribed by the Libraries Acts under which public libraries can be established. In rural parishes a parish meeting, called upon a requisition signed by ten or more voters and held at the time and place appointed, may adopt the Acts by a bare majority of those present and voting. At least seven days' notice of the meeting must be given, but it is better to allow a month. Should a poll be demanded, it must be conducted by ballot according to the rules laid down by the Local Government Board. Full particulars, including forms of requisition, will be found in Chambers and Fovargue's *Law Relating to Public Libraries*, London, Knight & Co., 1899, and in the authority quoted at the end of this chapter.

17. As already stated in Section 4, any county borough, urban district, burgh or other similar authority may adopt the Libraries Acts by a resolution of the council, without reference to the voters. A month's notice of motion must be given in the customary form, and a bare majority of the council can pass the resolution. A copy of the resolution adopting the Acts must be sent to the Local Government Board, and it must also be advertised in the local papers and posted on the doors of all the churches and chapels—where such notices are usually posted. It is best to make the resolution state a particular date when the Acts are to come into operation, as is required by the Scotch Act. In some places the Acts after being adopted have been allowed to become a dead-letter owing to neglect of this necessary precaution. As the urban districts and burghs are given power to fix the amount of rate within

the limitation of one penny, it is not necessary to include in the resolution adopting the Acts any stipulation as to the amount of rate. A useful form of resolution is as follows :—

That the Public Libraries Act (state date of principal Act) and all subsequent Acts amending the same be, and are hereby adopted, for the county borough of _____ (state place), and shall be in force throughout the borough (or other area) on and after the.....day of..... (state year).

18. As the power of adopting the Acts in populous areas is now vested in the local authorities, there is no longer, as formerly, any need to educate opinion among ratepayers as to the necessity for establishing public libraries. Most of the propagandist literature of a useful kind appears in the various books of Mr. Thomas Greenwood (*Public Libraries, British Library Year Book*, etc.), and these should be consulted by any one in a rural parish who desires to raise the question in a practical form. As regards urban districts the initiative may safely be left in the hands of the intelligent members of council, who will sooner or later move in the direction of placing their districts in line with most of the other large towns in the country.

19. At present about 450 towns and districts in the United Kingdom have adopted the Public Libraries Acts, and this number includes practically every large town in the country. The principal areas still unprovided with public libraries are the Metropolitan Boroughs of Islington, St. Pancras, Hackney, Marylebone and Paddington (part), and the towns and districts of Bacup, Batley, Crewe, Dover, Jarrow, Scarborough, Swindon, Torquay, Weymouth, Llandudno, Rhondda, Govan, Leith, Pollokshaws and Wishaw. No doubt most of these places, along with others, will equip themselves with libraries before long, in order to place themselves on an equal footing with neighbouring towns.

20. Endowments.—Little need be said about the foundation of public libraries by endowment or bequest. The wills of Stephen Mitchell and George Baillie, of Glasgow, are models of what a liberal bequest should be, both as regards the amounts

Sec. 21] ADOPTION OF ACTS AND FOUNDATION.

bequeathed and the conditions laid down for the formation of the library itself. The practical condition attached to all the gifts made by Mr. Andrew Carnegie and Mr. J. Passmore Edwards for public library purposes should be adopted by every benefactor who proposes to found a library. This is the very sensible one that, if the gift of money is accepted by the community, the local authority must adopt the Public Libraries Act in order to maintain the library in a state of efficiency for all time. The only alteration we would suggest in the form of future bequests is this, that when money is offered to a small town on the condition that it adopts the Libraries Acts, the whole of the gift should not take the form of a building fund. Small towns usually have very inadequate incomes from the library rate, and for this reason it would be wise if a fair proportion of the gift was directed to be invested as a book fund. A huge library building without books, like some of those erected in Cornwall by Mr. Passmore Edwards, is not quite as useful to the people as a much less ambitious building, provided with a fund which permits of the annual purchase of £50 to £100 worth of books, independent of the library rate.

21. REFERENCE:—

Fovargue (H. W.) Adoption of the Public Libraries Acts in England and Wales. (L. A. Series, No. 7.) 1896.

CHAPTER III.

COMMITTEES.

22. Appointment of Committees.—The first step after the Libraries Acts have been adopted by a local authority will be the appointment of a committee, and it is desirable that only capable men should be elected. The best interests of the library will be served by a committee consisting of good business men and literary or professional men or women, in about equal proportions. It is quite evident that the legislature did not contemplate the formation of public libraries by committees of the rank and file of local authorities, who are chiefly concerned with paving, drainage and other equally material matters. By Section 15, Sub-section 3, of the "Public Libraries Act, 1892," it is ordained that "an urban authority may if it think fit appoint a committee and delegate to it all or any of its powers and duties under this section, and the said committee shall to the extent of such delegation be deemed to be the library authority. Persons appointed to be members of the committee need not be members of the urban authority." The "Public Libraries (Ireland) Amendment Act, 1877," gives similar power to elect members outside the local authority. Section 4 ordains that "the committee in which the general management, regulation and control of such libraries, museums or schools may be vested under the provisions of the 12th Section of the principal Act, may consist in part of persons not members of the council or board or commissioners". By the "Public Libraries Consolidation (Scotland) Act, 1887," Section 18 ordains that the local authority shall "appoint a committee, consisting of not less than ten nor more than twenty members, half of whom shall be chosen from amongst the magistrates and council, or board, as

the case may be, and the remaining half from amongst the householders of the burgh or parish other than the magistrates and council, or board, and three members of such committee shall form a quorum". It is further ordained, Section 21, that this committee "shall manage, regulate and control all libraries and museums established under this Act, or to which this Act applies : and shall have power to do all things necessary for such management". It is thus clear that local authorities are fully empowered to select the best expert advice it is possible to obtain in the district, and that the administration of the library should not rest entirely in the hands of the local authority. We therefore advise that library committees be composed of members selected from among the best qualified citizens, with a good proportion of members of the local authority.

23. Constitution of Committees.—The portions of the Acts already quoted make it plain that in Scotland the library committees shall be independent bodies, with power to provide everything necessary, without requiring the sanction of the local authorities, or doing more than from time to time reporting their proceedings. In Ireland, under Section 12 of the principal Act, "the general management, regulation and control of such libraries and museums, etc., shall be, as to any borough, vested in and exercised by the council or board, and as to any town, in and by the town commissioners, or such committee as they respectively may from time to time appoint, who may from time to time purchase and provide the necessary fuel, books, appoint and dismiss officers, make rules," etc. This approximates closely to the English law, which differs from that of the Scottish, in leaving the power of appointing an independent or semi-independent library committee in the discretion of the local authority. We have already quoted the English Act in the previous section, and it now remains to give reasons why we consider that every Public Library Committee should be independent of the control of the local authority, save for certain purposes. The fact that, in Scotland, the hybrid composition of the committee is regarded as a reason for making it practically independent of the local authority, offers a strong

argument in favour of a similar course being pursued in England and Ireland. A mixed committee is entitled to act without the special sanction of the local authority, if only for the reason that all its members cannot take part in the ratifying proceedings of the council or board. It seems absurd, on the face of it, to invite capable citizens who are not members of the council to pass certain resolutions and then submit them for confirmation to a council on which they have no vote or voice. Furthermore, a committee of any kind appointed to administer an Act, like the Public Libraries Act, which lays down clearly what may be done and how much may be expended, does not require the same kind of oversight and control as an ordinary committee appointed for some municipal purpose with comparatively unlimited powers of expenditure. No committee appointed for an educational purpose should be subject to the delays and difficulties caused by having to submit all its proceedings for confirmation by a superior authority. All these arguments furnish reasons why local authorities in England and Ireland should follow Scotland in giving Public Library Committees a complete or partial delegation of powers under the Public Libraries Acts.

24. *Delegation of Powers.*—A delegation of powers under the various sections of the Acts quoted should provide for a fair measure of independence for the committee, with a fair share of general control on the part of the local authority. As a matter of policy, as well as in the public interest, it is very desirable to maintain harmonious relations between a central board and its acting committees, and for these reasons information as to the proceedings of a committee should always be available. But, for the reasons already set forth, we think a Public Library Committee should be a *reporting* and not merely a *recommending* body. With the exception of public libraries in the Metropolitan Boroughs, which are compelled by Section 8 (3) of the "London Government Act, 1899," to receive the sanction of the Borough Council and its Finance Committee for expenditures over £50, every Public Library Committee in England and Ireland should be constituted under a special delegation of

powers, such as was contemplated and authorised by the Acts already quoted. A fair and workable form of delegation of powers, which has been adopted with good results, is as follows :—

That the [name of authority] hereby delegate to the Public Library Committee all the powers and duties vested in it as the Library Authority under the Public Libraries Acts, 1892, and all subsequent amendments, with the following reservations :—

1. The sanction and raising of loans for new buildings or other purposes.
2. The making and collection of the annual library rate.
3. The confirmation of agreements with adjoining library authorities for the joint use of libraries.
4. The confirmation of the appointment or dismissal of the librarian.
5. The sanction of any scheme for the formation of branch libraries.
6. The proceedings of the Public Library Committee to be reported monthly to the [name of authority], but only for confirmation and sanction as regards Clauses 1 to 5 of this constitution.
7. The librarian to act as clerk to the Public Library Committee.

As regards Metropolitan Borough Councils, it may be desirable to add a clause to the effect that no expenditure exceeding £50 be incurred without an estimate being first obtained by the Finance Committee of the Borough Council. But it is doubtful, if even this restriction is necessary, if, when the rate is made, the Borough Finance Committee passes an estimate for the whole amount of the public library rate, to be expended on general library purposes according to a budget or scheme prepared by the Public Library Committee. This will get over the difficulty of having to obtain fresh estimates every time £50 worth of books are ordered. The "Public Libraries Act (Amendment) Act, 1901," contains a clause making it quite clear that for library purposes a Metropolitan Borough is an urban district.

25. Standing Orders.—The standing orders or bye-laws regulating Public Library Committees need not be very elaborate. Generally, they should be the same as those governing other committees of the local authority, with the exceptions as to powers. A chairman should be elected annually by the committee. The committee should be elected annually by the local authority, and the number of members should be small

rather than large. The needs of districts differ, but a Public Library Committee of over twelve is more likely to be an encumbrance than a help to the institution. A meeting should be held once a month at least. Reports of proceedings should be submitted to the local authority at least once a month. Three members should form a quorum. A rota of visitors should be fixed to visit the libraries between meetings of the committee, and report on their condition or needs. Sub-committees may be formed for book selection, finance or special purposes. In these cases no quorum need be fixed. The committee or a special finance sub-committee should regularly examine the accounts and petty-cash disbursements and receipts of the librarian or clerk. The committee should control its own clerk, who ought to be the librarian. The Public Libraries Acts require that a separate account be kept of receipts and expenditure from the library rate, and library committees should see that this is done in all cases where the accounts are kept and payments made by the council officials. Other details respecting accounts are considered in Chapter IV. The rules for committees of non-municipal libraries have already been referred to in Section 11.

26. Duties of Committees.—To a considerable extent these are fixed by the delegation of powers granted and the standing orders adopted. But there are certain matters of control and policy which every library committee should regularly supervise. These will appear clear if set out in regular order as follows:—

1. General oversight of buildings, staff and the work of the various departments of the library.
2. Careful supervision of the selection of books.
3. Compilation and revision of public rules and regulations. (*See Chapter XXVII.*)
4. Regular checking of accounts and expenditures, including those of all officers.
5. Regular meetings on fixed dates, at least once a month.
6. Constant visits to the library by members of the committee in rotation.
7. Every member of committee should become acquainted with the elements of public library administration, and for this purpose should possess copies of all the live Acts of Parliament (*see Section 15*) and works like

the *British Library Year Book* and the *Manual of Library Economy*.
 (See also other books named in reference lists of authorities, Section 88, etc.)

27. Minutes.—When library committees report regularly to the central local authority, their minutes will be printed as part of those of the council or other body. In other cases a

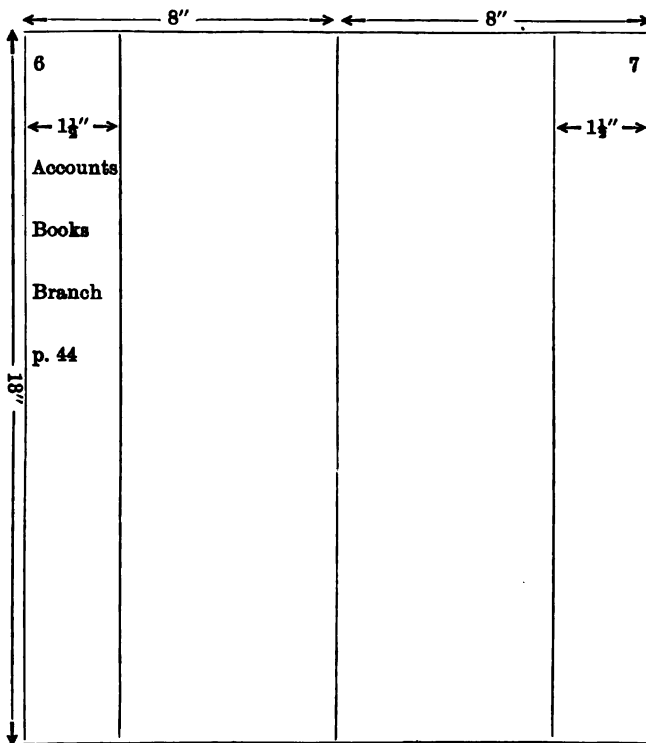

FIG. 1.—Minute Book Ruling.

proper minute book should be kept by the clerk or librarian, in which all resolutions of the committee should be entered in correct form. As the minute book is occasionally required by the auditors, and frequently for other purposes, it should be kept fully indexed. A convenient form of minute book is one with a wide margin on every page, ruled faint, and paged

throughout. The size should be brief or foolscap folio, and the paper should be of the best hand-made kind, with strong and suitable binding. A permanent record of this kind ought to be of an enduring nature. The wide margins will serve as a rubric on which can be entered brief catch-words to enable resolutions to be quickly identified.

Needless to say, a minute book should be kept scrupulously clean, neat and up-to-date. Minutes which are likely to cause a discussion at the council meeting should be submitted to the chairman, or other member of committee who may have to move and support them. Neglect of this necessary precaution often causes a *fiasco*.

28. **Agenda.**—The summons to a committee meeting should contain an agenda of the business to be transacted, and it is a convenient plan to have a special form for the purpose, printed on an octavo or post-quarto sheet, with flyleaf:—

| | |
|--|--|
| LIBERTON PUBLIC LIBRARY. | |
| [Address]..... | |
| [Date]..... | |
| <p>You are requested to attend a meeting of the Public Libraries Committee on.....at when the following agenda will be considered.</p> | |
| <p>Yours faithfully,</p> <p>.....</p> <p style="text-align: right;"><i>Clerk.</i></p> | |
| <p>AGENDA :—</p> <p>1.....</p> <p>2.....</p> <p>3.....</p> <p>4.....</p> <p style="text-align: center;">etc.</p> | |

FIG. 2.—Summons to Committee Meeting.

If it is the practice to send out lists of books proposed, these can be enclosed, and form one of the numbered items for consideration. Sub-committees, if any, can be summoned on the same form by writing in the word "Sub" before the word "Committee," but unless the sub-committees meet on the same dates as the general committees, a separate form should be prepared.

29. It is a wise plan for a librarian, who acts as clerk, to talk over the agenda with his chairman before sending it out. Very often a good proposal coming from the librarian is wrecked because it comes upon all the members as a surprise, and, if not dismissed there and then, it is postponed for further consideration. It should be made a rule on the part of a librarian never to broach any important subject without first talking it over with his or her chairman and one or two other influential members of committee.

30. **Order of Business.**—The business procedure of library committees differs in various towns, and of necessity must be arranged to suit special circumstances. The ordinary rules which regulate committee meetings apply in the case of libraries, and there is no need to enlarge on the subject. In making up agendas the following order of business will be found useful:—

1. Minutes of last meeting.
2. Accounts and finance. (Including such questions as salaries, etc. The Bank Pass Book and the Librarian's Petty Cash Book, Cash Receipts Book, etc., should be produced here.)
3. Books and periodicals.
4. Matters arising out of the minutes of last meeting:—
 - (a) ———
 - (b) ———
 - (c) ———
5. Special important business:—
 - (a) ———
 - (b) ———
 - (c) ———
6. Reports:—
 - (a) Librarian's, on work of library.
 - (b) Donations.
 - (c) Visitors.
 - (d) Special.
7. Correspondence.
8. Matters of urgency.

As Nos. 2 and 3 are usually sub-committee reports, it is as well to dispose of them at once.

Certain items come up regularly once a year, such as contracts, insurance, lists of periodicals, subscriptions, salaries, budget, etc. These should be carefully noted in a diary so as to secure their due consideration at the proper time.

31. Attendances.—A book should be kept in which members of committee can register their attendances at meetings. This is a more satisfactory and legal method than a note kept by the clerk. It is also less liable to challenge, or, if challenged, more convincing to show a member's actual signature denoting attendances than to rely simply upon a clerk's memory. A plain quarto or foolscap folio book, ruled faint, and half-bound in leather, will serve every purpose. A similar book should be kept for recording the visits and reports of committee-men, as recommended in Sections 25 and 26 (No. 6). It is usual to compile from the attendance book a table of the number of meetings attended by members of committee for publication in the annual report of the library or minutes of the local authority. A convenient form of table for attendances can be ruled thus:—

| Name. | General Meetings. | | Committee Meetings. | | Total Attendances. |
|---------------|-------------------|------------|---------------------|------------|--------------------|
| | Sum-moned to. | At-tended. | Sum-moned to. | At-tended. | |
| Mr. A | 12 | 10 | 9 | 3 | 18 |
| „ B | 12 | 12 | 12 | 12 | 24 |
| „ C | 12 | 3 | 9 | 6 | 9 |

FIG. 8.—Committee Attendance Register.

32. REFERENCE LIST OF AUTHORITIES :—

- Ballinger, J. Constitution of Public Library Committees. L., v. 7, p. 1.
- Crunden, F. M. The Function of Library Trustees (American). Lib. J., 1896, Conf. no., p. 32.
- Greenwood, T. Public Library Committees. See his "Public Libraries," 1894, p. 352.
- Jones, H. Library Authorities, their Powers and Duties. Int. Con., 1897, p. 23.
- Notes for Library Committees. Greenwood's Year Bk., 1900, p. 1.
- Rawson, H. Duties of Library Committees. Int. Con., 1897, p. 27.
- Soule, C. C. Trustees of Free Public Libraries. (Duties, qualifications, etc., of American.) Lib. J., 1890, Conf. no., p. 19.
- Utey, H. M. Government, Constitution, Bye-laws and Trustees. U. S. Edu. Rept., 1892-1893, v. 1, p. 748.

For list of abbreviations see Section 88.

CHAPTER IV.

FINANCE, LOANS, ACCOUNTS, REPORTS.

33. **The Library Rate.**—The general library Acts passed for Ireland, Scotland and England all limit the amount to be raised by rate for library purposes to one penny in the pound on the annual rateable rental of all properties within the area, with certain exceptions or modifications as to gardens and agricultural lands. These we need not pause to consider, save that, as regards rural parishes, the allowance of two-thirds of the library rate on account of cultivated lands enforces our point as to the utter inadequacy of a limited library rate in such parishes. (See Section 7.) Great doubt exists as to what is meant by a penny rate and on what value it is to be levied. Some authorities maintain that the income from a penny rate can only represent the net sum realised by a penny on the rateable value, after all deductions have been made on account of empty houses and other irrecoverable items. Against this may be set the actual practice in several places, of paying over the full sum which a penny rate on the nominal rateable value would produce, without any deductions whatsoever. As the Public Libraries Acts have placed a limitation on the amount of the library rate, it may be assumed that the libraries were intended to benefit to the full extent of the rateable value. At any rate the Acts are silent on the point, and practice differs so much that we have no hesitation in saying that a public library, because of the present limitation, and because some places now give the full product, is entitled to the full amount which a penny rate would yield when calculated on the full rateable value of the town or

Sec. 34] FINANCE, LOANS, ACCOUNTS, REPORTS.

district, without deduction of any kind, either for unproductive properties or cost of collection. It has been decided in one case¹ that no deduction can be made from the income produced by the library rate on account of the cost of collection, and as this rate is now collected as part of a general or other unlimited rate, it seems very unfair to saddle it with any part of the cost of collection. If it were collected as a separate rate, or with rates similarly limited by Act of Parliament, the position would be different. To show the difference between the amount paid over to public libraries and the actual sums which would be produced were the rate charged on the full rateable value, we sub-join a table² showing the results in various places:—

34.

| | Rateable Value. | Produce at 1d. | Actual Amount Paid. | Annual Loss. |
|----|-----------------|----------------|---------------------|--------------|
| | £ | £ | £ | £ |
| 1 | 1,400,009 | 5,833 | 5,151 | 682 |
| 2 | 1,124,852 | 4,686 | 4,100 | 586 |
| 3 | 942,000 | 3,925 | 3,380 | 545 |
| 4 | 916,729 | 3,819 | 3,495 | 324 |
| 5 | 829,388 | 3,455 | 3,100 | 355 |
| 6 | 787,065 | 3,279 | 3,014 | 265 |
| 7 | 757,969 | 3,158 | 2,766 | 392 |
| 8 | 451,212 | 1,880 | 1,650 | 230 |
| 9 | 413,218 | 1,721 | 1,400 | 321 |
| 10 | 354,114 | 1,475 | 1,300 | 175 |
| 11 | 271,845 | 1,182 | 1,050 | 82 |
| 12 | 122,290 | 509 | 450 | 59 |
| 13 | 67,749 | 282 | 220 | 62 |
| 14 | 38,781 | 161 | 150 | 11 |

This shows a very considerable loss in every case, ranging from over 20 per cent. to 5 per cent., and furnishes another proof of the dangers and restrictions which are likely to arise when

¹ The District Auditor at Chelsea disallowed the charge made for collecting the library rate.

² These figures are taken from the *British Library Year Book*, 1900, and the *Municipal Year Book* for the same year, and can only be regarded as approximate.

rapidly growing institutions are compelled to exist on strictly limited and inelastic incomes.

35. Unexpended Balances.—In some places the local authority, or the town clerk acting on its behalf, has appropriated unexpended balances of the public library rate and applied them to other local purposes. This action is clearly illegal, and could only have been taken by those who are ignorant of the decisions of the Local Government Board on the point. It is true the Acts do not specify how unexpended balances of the library rate are to be dealt with, but it is equally true that as the money was raised under a special Act for a strictly defined purpose, it cannot be diverted to any other purpose, nor can it be carried forward as a portion of the library rate for a succeeding year. No doubt the wording of the Act is responsible for the interpretation which has been put upon the section entitled "Limitations on expenditure for purpose of Act". It reads: "A rate or addition to a rate shall not be levied for the purposes of this Act for any one financial year in any library district to an amount exceeding one penny in the pound". The argument has been advanced that if a penny rate is levied in one year and a balance remains it would be giving more than a penny rate if another penny were levied the next year! The absurdity of this interpretation is only equalled by its gross injustice. The Local Government Board has decided, however, that any unexpended balances of the library income must be carried forward to next year's library account, without prejudice to the next year's library income. This decision has been upheld by all the district auditors of the Local Government Board, and it is difficult to understand the reason why a certain number of places still cling to the belief that the library rate can be further limited by this illegal procedure of appropriating unexpended balances. Committees who are threatened with this action can always protect themselves against the injustice by taking care that there are no balances to appropriate; but it will prevent them from saving a little money for necessary book purchases, cleaning or other purposes. It should be pointed out, furthermore, that the section

Sec. 36] FINANCE, LOANS, ACCOUNTS, REPORTS.

of the Act above quoted does not really refer to the total *amount* to be raised by rate in a given year, but only to the *poundage* or rate which may be charged for library purposes, namely, not more than a penny in the pound. The question of the *product* of this rate of a penny is not mentioned anywhere in the Acts, and it is this lack of clear definition—the failure to distinguish the amount of a rate from the total amount which it will annually produce—which is responsible for most of the difficulties hitherto met with in administering the Libraries Acts.

36. Loans.—The Libraries Acts give pretty full instructions as to loans for public library purposes. In England under the principal Act “every library authority, with the sanction of the Local Government Board . . . may borrow money for the purposes of this Act on the security of any fund or rate applicable for those purposes”. In parishes the regulations for borrowing prescribed by the “Local Government Act, 1894,” are to apply. As a preliminary to borrowing, an inquiry is held locally by a Local Government Board inspector, who receives evidence as to proposed buildings, sites, amount required, etc., and also hears objections to the proposal. The Local Government Board print bills announcing the inquiry, and these must be posted and paid for by the library authority in the usual way. At such inquiries full particulars should be prepared as to income, date of adopting Acts, etc., as well as particulars of the scheme proposed to be carried out. After the inquiry is held it is generally about three months later before the sanction of the Board is received. This states the amount sanctioned and for what period the money can be borrowed for sites, buildings, furniture or books, as the case may be.

The security for loans is declared by the “Public Health Act, 1875,” Section 233, to be the “credit of any fund or all or any rates or rate out of which they are authorised to defray expenses incurred by them in the execution of this Act”. And it is further laid down that “they may mortgage to the persons by or on behalf of whom such sums are advanced any such fund or rates or rate”. It thus appears that neither library buildings nor the library rate can be mortgaged for the purposes of library

loans, but only the rate or rates out of which the expenses of the Public Health Act are paid. This practically means the general rate of a district.

37. The Local Government Board will fix the period for which sums of money for particular purposes may be borrowed. Generally the periods are as follows:—

| | |
|--|------------------------|
| For sites or lands | 60 or 50 years. |
| „ buildings (including fixtures like counters, screens, wall and standard bookcases, wall news- paper slopes, barriers, etc.) . . . | 30 years. ¹ |
| „ books | 10 „ |
| „ furniture (tables, chairs, desks, and movable furniture only) . . . | 10 „ |

The money may be borrowed from the Public Works Loan Commissioners, County Councils, Banks, Friendly Societies or private individuals. The rate of interest varies, according to the cheapness or otherwise of money at the time. $3\frac{1}{2}$ per cent. may be regarded as a fair average interest, but library authorities have borrowed for as low as 3 per cent.

38. The methods of repayment vary, and this must be entirely a matter for local arrangement, and should follow the practice in vogue with other municipal loans. An equalised repayment of principal and interest on the annuity system has the advantage of distributing the payments uniformly over the whole period, and of placing part of the burden on succeeding ratepayers as well as upon those who establish the library. This is much fairer than making the pioneer ratepayers practically bear the whole foundation cost of establishing an institution which increases in its value to the community as it progresses. In Scotland repayments of principal must be made from a sinking fund which is to be formed from a certain proportion of the rate put aside annually.

39. The arrangements for negotiating a loan and drawing up the necessary deeds should be placed in the hands of a

¹ A loan for purchasing an existing building will not be sanctioned by the Local Government Board for a period exceeding 20 or 25 years.

Sec. 41] FINANCE, LOANS, ACCOUNTS, REPORTS.

solicitor if the library authority is a semi-independent committee, but usually the accountant or town clerk of the district is responsible for all arrangements, and will see that the deed is duly sealed as prescribed by the Act.

In connection with this it should be noted that by Section 237 of the "Public Health Act, 1875," a register of the mortgages on each rate must be kept, and that "within fourteen days after the date of any mortgage an entry shall be made in the register of the number and date thereof, and of the names and description of the parties thereto, as stated in the deed". Furthermore, "every such register shall be open to public inspection during office hours at the said office [local authority's office] without fee or reward". As the auditor will call for this register, the clerk to the library authority should see that it is provided, if the local authority have not already done so. An authorised form of register can be obtained from Messrs. Knight & Co., Local Government publishers, 4 La Belle Sauvage Yard, Ludgate Hill, London, E.C.

40. The arrangements for loans in Ireland and Scotland are somewhat similar to those just described. In Ireland no power to borrow was given under the principal Act, but the Amendment Act of 1877 gives the power, provided the commissioners of His Majesty's Treasury approve. The Commissioners of Public Works in Ireland may lend, and power is given to mortgage, as security, either the borough fund, town fund, or the library rate itself. In Scotland the local authority may borrow, without any other consent, on mortgage or bond on the security of the library rate, a sum or sums not exceeding the capital sum represented by one-fourth part of the library rate, capitalised at the rate of twenty years' purchase of such sum. A sinking fund must be formed, consisting of an annual sum equal to one-fiftieth part of the money borrowed, which is to be invested and applied to the purpose of extinguishing the debt.

41. Before leaving the question of loans, it may be well to offer a word of warning against the danger of overborrowing, which has very seriously crippled the work of various libraries. In some places as much as one-half the library income has to

be devoted to the repayment of the principal and interest of loans ; in others, one-third is similarly spent. In our opinion one-fourth of the library income is the maximum which in any case should be set apart for the purpose.

42. Accounts.—By the principal English Act, Section 20 (1), it is ordained that “separate accounts shall be kept of the receipts and expenditure under this Act of every library authority and its officers, and those accounts shall be audited in like manner and with the like incidents and consequences, in the case of a library authority being an urban authority, and of its officers, as the accounts of the receipts and expenditure of that authority and its officers under the Public Health Acts”. In Ireland the same provisions apply, that is, library accounts are to be kept and audited like those of the local authority, and copies of the accounts are to be sent within one month after auditing to the Lord Lieutenant. In Scotland the accounts are to be kept separately in special books, and are to be audited by “one or more competent auditors”. In all cases the books are to be open to public inspection, and in Scotland abstracts of the accounts are to be inserted in one or more newspapers published or circulated in the district.

43. No special system of library book-keeping has been laid down, the nearest approach to a form being that prescribed by an order of the Local Government Board, dated 26th November, 1892, for parishes whose library accounts are audited in like manner to those of Poor Law Guardians. (See Section 51.) In Greenwood's *Public Libraries*, fourth edition, 1894, pages 343-345, some details are given of this system, and we may recommend the whole plan as being the simplest and most effective yet formulated.

It provides for a separate banking account, and usually the banker acts as treasurer, unless there is a duly appointed borough treasurer or other officer. To this account the local authority pays all amounts received on account of the library rate or loans, and the library authority or librarian pays all cash donations and money received from fines, subscriptions, sale of catalogues, waste-paper, etc. Cheques, in a separate

Sec. 44] FINANCE, LOANS, ACCOUNTS, REPORTS.

cheque book, are drawn by the borough treasurer, or in Scotland, and where special powers have been given, by the library authority. In London boroughs the cheques for all payments must be drawn by the finance committees of the councils.

The principal books of account required are the cash book, ledger, petty cash book, cash receipts book, postage book and sometimes a wages book.

44. The CASH BOOK contains the record of all money transactions, and is practically a duplicate of the bank pass book, which, of course, is kept by the banker. On the receipts or left side of the folio are entered any balances brought forward, amounts received from rates, fines and penalties, sale of catalogues, etc., donations and subscriptions, parliamentary grants,

| 12 | | RECEIPTS. | | | | | |
|------|---|-----------|----------------------------|-------------|-----|----|---|
| | | Account. | | Ledger fol. | | | |
| 1901 | | | | | | | |
| Mar. | 9 | Rates | By Library Rate, 1900-1901 | 10 | 500 | 0 | 0 |
| Apl. | 1 | Fines | „ Cash, March | | 6 | 14 | 9 |

| EXPENDITURE. | | | | | | 12 | |
|--------------|----|-----------|------------------------|-------------|----|----|---|
| | | Account. | | Ledger fol. | | | |
| 1901 | | | | | | | |
| May | 20 | Buildings | To Johnson & Co. . . . | 12 | 15 | 0 | 0 |
| „ | 30 | Books | „ Miles & Co. | 14 | 5 | 0 | 0 |

FIG. 4.—Cash Book.

loans, etc. On the expenditure or right side of the folio are entered all cheques drawn on account of buildings, books, salaries, establishment charges, petty cash, interest and principal of loans, etc. The ruling given below is an ordinary form of cash book, but it may also be ruled in a classified manner, with columns for each main head of receipt and expenditure, similar to the classified petty cash book shown below. An ordinary foolscap size will do for the style of ruling shown in Fig. 4. This book is posted into the ledger as shown above, each item going to its own account and the ledger folio being entered in the special column.

45. The LEDGER is an abstract of all the financial operations of the library. It is kept in a series of separate accounts for each kind of receipt and expenditure, and not in the style of an ordinary commercial ledger, which shows transactions with individuals chiefly. A credit ledger in which an account is kept with each individual tradesman will, however, be found useful, either as an addition to, or substitute for, an invoice book. A separate page should be opened for each of the following accounts, and the operations of each financial year must be kept together consecutively:—

| RECEIPTS. | EXPENDITURE. | OTHER. |
|------------------------------|---|-----------------------------------|
| Rates. | Buildings, repairs, maintenance. | Receipts and expenditure account. |
| Fines and penalties. | Books, periodicals, binding. | Balances. |
| Sale of catalogues, etc. | Salaries of officers and assistants. | |
| Donations and subscriptions. | Establishment charges (stationery, printing, postages, carriages, rent, rates, taxes, insurance). | |
| Other: bank interest, etc. | Loans: Principal. | |
| | „ Interest. | |
| | „ Lenders' accounts. | |
| | „ Separate accounts for buildings, furniture, etc. | |
| | Librarian: Petty cash account. | |

Sec. 45] FINANCE, LOANS, ACCOUNTS, REPORTS.

The following ruling will be found useful :—

| | | | | | | | | | |
|-----------------------|----------------------------------|--|----|------|---|---|-------|---|------------|
| 8" | | | | | | | | | |
| 10 | <i>Cr.</i> LIBRARY RATE ACCOUNT. | | | | | | | | |
| 1901 | | | | C.B. | | | | | |
| Jan. | 6 | By Rate, 1900-1901 . . | 20 | 500 | 0 | 0 | | | |
| Mar. | 5 | " 1900-1901 . . | 22 | 300 | 0 | 0 | | | |
| Oct. | 30 | " 1901-1902 . . | 28 | 600 | 0 | 0 | | | |
| | | | | | | | 1,400 | 0 | 0 |
| | | | | | | | 1,400 | 0 | 0 |
| LIBRARY RATE ACCOUNT. | | | | | | | | | 10 |
| <i>Dr.</i> | | | | | | | | | <i>Dr.</i> |
| 1901 | | | | Lr. | | | | | |
| Dec. | 31 | To Balance transferred to Receipts and Ex- penditure Account . | 40 | | | | 1,400 | 0 | 0 |
| | | | | | | | 1,400 | 0 | 0 |

FIG. 5.—Library Ledger (Section 45).

The items from the cash book are posted into the ledger under their respective accounts, and the folio of the cash book is carried into the appropriate column. Each ledger account must be balanced separately, and the totals carried to the receipts and expenditure account, which is a kind of annual abstract or balance sheet. The items from the petty cash account should also be carried into the totals of the various accounts in order to obtain a correct statement. The balances account is the summary of balances carried forward from the last account put against the balances in hand at the end of the year, and is generally signed by the auditor.

| | | |
|-----------------|------------------------------------|-----|
| RECEIPTS. | | 11" |
| 24 | | |
| 1901 Mar. 26 | By Cheque for Petty Cash | 7½" |
| 10 | 0 | 0 |
| | | 1½" |
| 10 | 0 | 0 |

| | | | | | | |
|--|-------------|-------------|-----------|----------------|---------------------------------|-----|
| EXPENDITURE. | | | | | | 24 |
| Date. | Buildings. | Books. | Salaries. | Establishment. | Total. | |
| 1901 April 6 " 12 " 15 | 0 1 0 | 0 1 0 | | 0 4 6 | 0 4 1 0 0 1 0 | 1½" |
| To W. Smart . . . " J. Ellis . . . " T. Cooper . . . | 0 1 0 | 0 1 0 | | 0 4 6 | 0 4 1 0 0 1 0 | 1½" |
| 1½" | 1½" | 1½" | 1½" | 1½" | 1½" | 8" |

FIG. 6.—Petty Cash Book (Section 46).

Sec. 45] FINANCE, LOANS, ACCOUNTS, REPORTS.

| CASH RECEIPTS FROM FINES. | | | | | | |
|---------------------------|------------|-----------------|-----------------|--------------|------------|------------|
| Date. | Id. | Voucher Numbers | 2d. | Noa. | 3d. | |
| 1901 March | 2 1 7 | 88 67-88 65 | 2 11 2 | 872-878 | 1 6 6 | |
| | ← 1 1/2" → | ← 1 1/2" → | ← 1 1/2" → | ← 1 1/2" → | ← 1 1/2" → | ← 1 1/2" → |
| | ← 2 1/2" → | | | | | |
| 12 | | | | | | |
| CASH RECEIPTS FROM FINES. | | | | | | |
| Noa. | 6d. | Noa. | Noa. | Total. | | |
| 69 92-70 97 | 0 15 6 | 29 02-29 32 | 1901 April 1 | Paid to Bank | 6 14 9 | |
| ← 1 1/2" → | ← 1 1/2" → | ← 1 1/2" → | ← 1 1/2" → | ← 1 1/2" → | ← 1 1/2" → | ← 1 1/2" → |
| | | | | | | |
| 12 | | | | | | |

Fig. 7.—Cash Receipts Book (Section 47).

Continued.

46. The **PETTY CASH BOOK** contains the librarian's account of all sums received and expended by him for small items. It is best kept in a classified form, as shown in the ruling given before, so as to dispense with the need for an abstract. The items are posted into the librarian's petty cash account in the ledger, the totals only under each heading being shown, with the balance in hand and receipts. (Fig. 6.)

47. The **CASH RECEIPTS BOOK** is the record of all amounts received at the library for fines for overdue books, sale of catalogues, lost books, waste-paper, subscriptions, etc. A useful form of ruling is shown below. This should be simply ruled in columns without headings, which must be supplied in MS. according to the nature of the items. A separate folio can be opened for all varieties of fines, as shown in our ruling, another for catalogues, lists, reserves, lost books, waste-paper, etc., and another for subscriptions. The columns provided will be found ample for most libraries. Of course, separate books should be provided for branches, and separate pages can be used for receipts from lectures, exhibitions, or other sources. The purpose of the ruling is to show the various kinds of item from which cash receipts are obtained, and to show also the numbers of the vouchers, so that they can be easily checked. This book should be made up monthly, and all payments to the bank or treasurer should also be made once a month. (Fig. 7.)

48. The **POSTAGE BOOK** is the record which shows the amounts expended on stamps from petty cash, and also accounts for their disposal. The following ruling will be found amply detailed:—

Sec. 49] FINANCE, LOANS, ACCOUNTS, REPORTS.

8"

12 1/2"

| Date. | To whom sent. | Subject. | Amount. | | |
|-------|---------------|----------|---------|--|--|
| | | | | | |

FIG. 8.—Postage Book.

There are more elaborate registers than this, which give columns for the time of posting and the initials of the person responsible for posting, etc. But these are refinements on the simple requirements of a public library, where it would probably not be needful to trace a missing or miscarried letter once in six months. When stamped post-cards are ordered as stationery, a record of their disposal should be kept in a separate pass book. This also applies to post-cards with stamps which are used for notifying overdue books, reserved books, etc.

49. A wages book is sometimes kept to show amounts expended on weekly wages, with a column for the recipient's signature. We advise the use of salaries and wages sheets

instead. They have the advantage of being in a form which enables them to take their place with all the other vouchers, and they also serve as a formal account when drawing wages money in advance. Convenient forms of salaries and wages sheets are shown below, which enable the money to be drawn monthly and paid weekly or otherwise as required :—

| LIBERTON PUBLIC LIBRARY. | | | | | | |
|---------------------------------|---------------|---------|---------|---|---|-------------------|
| MONTHLY SALARIES FOR MAY, 1901. | | | | | | |
| Paid per Mr....., Librarian. | | | | | | |
| Name. | Office. | Period. | Amount. | | | Received Payment. |
| Mr. — | Librarian | May | 90 | 0 | 0 | Stamps |
| Mr. — | Sub-Librarian | „ | 12 | 0 | 0 | and |
| Mr. — | Assistant | „ | 8 | 0 | 0 | Signatures. |

FIG. 9.—Monthly Salaries Sheet.

A cheque for the total amount is drawn and paid to the librarian, who pays the staff and receives the receipt in the column headed "Received Payment". The sheet then becomes the voucher for payment. The weekly wages sheet is ruled exactly the same, the only differences being that it is headed Weekly Wages from — to —, 1901, and the weeks are shown as follows :—

| | | | | | | |
|----------------------|-------------------|----|----|----|-----------|---|
| Mr. Jones, Caretaker | Week ending May 1 | £1 | 10 | 0 | Signature | |
| „ | „ | „ | 8 | 10 | 0 | „ |
| „ | „ | „ | 15 | 10 | 0 | „ |
| „ | „ | „ | 22 | 10 | 0 | „ |

Other weekly wage earners are entered in similar extended fashion, and the cash is drawn by the librarian monthly.

Sec. 50] FINANCE, LOANS, ACCOUNTS, REPORTS.

When the receipts are all signed the sheet becomes the voucher for payment.

50. All vouchers or receipts for cheque payments should be obtained on *detailed* accounts or invoices, or else the invoices should be attached to the statements. Estimates should also be attached to the receipted accounts in cases where work has been done according to estimate. Receipts for petty cash payments should be obtained on forms of uniform size, in all cases where ordinary receipts are not given as a matter of course. Single crown octavo slips, printed as follows, will be found very useful as vouchers for small expenditures which have to be made over shop counters, etc. :—

| |
|---|
| Received from the Liberton Public Library Committee the sum of....., being payment for Date..... Signature..... |
|---|

FIG. 10.—Receipt Form.

The methods of filing accounts and other documents are discussed in Chapter XXIV. It need scarcely be added that all invoices and statements should be carefully checked by the librarian, and, if found correct, duly certified by having his or her initials added. When passed for payment by a committee accounts should be marked with a rubber stamp as under, and signed by the chairman :—

| |
|---|
| Passed by the Public Library Committee. Mar. 26, 1901. |
|---|

Rubber stamps with movable type can be obtained for the purpose. This is a very necessary practice when accounts have

to be transferred from a Public Library Committee to a local authority for payment.

51. Financial Statement.—The form of financial statement for public libraries in parishes, prescribed by the Local Government Board, alluded to in Section 43, is the best for all purposes. As shown in the section on Annual Estimates, it provides for every kind of receipt and expenditure. Printed blanks giving the whole of the items copied from the L. G. B. Order of 1892 are supplied by Messrs Knight & Co., La Belle Sauvage Yard, Ludgate Hill, London, E.C., at the price of 1s. each. In addition to a blank tabular form for showing particulars of loans, etc., the statement includes spaces for the undernoted items, all duly set out to form a balance sheet:—

FINANCIAL STATEMENT.

| RECEIPTS. | EXPENDITURE. |
|--|---|
| Rates. | Buildings, repairs, maintenance. |
| Fines and penalties. | Books, periodicals, etc. |
| Donations and subscriptions. | Salaries and remuneration of officers and assistants. |
| From parliamentary grants. | Establishment charges not before included. |
| From other local authorities. | Loans: Principal } Out of invested Sinking Fund. |
| From sale of securities in which sinking fund is invested. | repaid } Otherwise. |
| From all other sources, specifying them. | .. Interest. |
| Sale of catalogues, etc. | Payments to other local authorities. |
| etc. | Other expenditure. |

As we have already stated, library or local authorities cannot do better than make this financial statement the basis for the whole of their system of library accounts and book-keeping.

52. Audit.—In cases where library accounts are audited under the "District Auditors' Act, 1879," it is imperative that all the forms and consequences should be borne in mind. District auditors have power to surcharge expenditures for items which in their opinion cannot be legally incurred under the provisions of the Public Libraries Acts, and it should also be remembered that the committee-men who sign the disputed cheque are held liable. In cases of surcharge appeal for relief

Sec. 53] FINANCE, LOANS, ACCOUNTS, REPORTS.

should be made to the Local Government Board, when it is a first offence, or when there is good grounds for challenging the decision of the auditor. The cost of auditing accounts is laid down in the "District Auditors' Act, 1879," according to the following scale. The library authority is required to purchase the necessary stamps to cover the amount:—

| | | | |
|---------------|---------------|---------------------|------------------|
| Under £20 | = £0 5 | £2,500 and under | £5,000 = £5 0 |
| £20 and under | £50 = 0 10 | 5,000 | „ 10,000 = 10 0 |
| 50 | „ 100 = 1 0 | 10,000 | „ 20,000 = 15 0 |
| 100 | „ 500 = 2 0 | 20,000 | „ 50,000 = 20 0 |
| 500 | „ 1,000 = 3 0 | 50,000 | „ 100,000 = 30 0 |
| 1,000 | „ 2,500 = 4 0 | 100,000 and upwards | = 50 0 |

Needless to say, very few libraries will have to pay more than £10. The charges for auditing by a firm of chartered accountants are such as may be arranged.

53. Annual Estimates or Budgets.—The Scotch principal Act is the only one which requires an annual estimate or budget to be prepared by the library authority for the information of the local authority. Section 30 of the Act of 1887 provides that "The committee shall in the month of April in every year make up, or cause to be made up, an estimate of the sums required in order to defray the interest of any money borrowed, the payment of the sinking fund, and the expense of maintaining and managing all libraries and museums under its control for the year after Whitsunday then next to come, and for the purpose of purchasing the books, articles and things authorised by this Act," etc. This estimate has to be submitted to the local authority, who "shall provide the amount required out of the library rate to be levied by it, and shall pay over to the committee the sum necessary for the annual expenditure by it in terms of its estimate". It is a pity this wise regulation was not included in the English and Irish Acts, because nothing could more forcibly demonstrate the need for increased means than such annual budgets. They would be a continual reminder of the inadequacy of the penny rate, and in time would, no doubt, force local authorities to take action in the direction of obtaining an amendment of the Libraries Acts, or

seeking additional local powers of rating. Apart from this, an annual estimate should form part of the financial work of every library authority. It enables them to notice weak spots, to see what provision can be made for occasional necessary works like cleaning, decoration, extensions, etc., and generally it would act as a check on lavish expenditure in any direction. It will be observed by the specimen budgets which we have prepared that, even with the most economical management, it is only possible to undertake new work, such as equipping a new room, opening a branch, installing electric light, or cleaning the building, by trenching on the sum set aside for the purchase of books. When this has to be done, as unfortunately is the case everywhere, the library must suffer very greatly. It is a melancholy fact that, owing to the limitation of the library rate, the only elastic and available sum when anything extra is wanted should be the book fund. Public libraries were established for the main purpose of providing the people with reading, yet, so scant is the provision of means, that by the irony of circumstances, the book fund is the only part of a library's economy which is ever seriously threatened or crippled. Any one who carefully examines the specimen budgets we have prepared will be at once struck by the truth of this statement.

Suppose the £2,000 library shown in the budget (Fig. 11) requires to spend £100 on cleaning work, a new catalogue, or on any other occasional matter, it can only use part of the book fund for the purpose, and so seriously impair the library's efficiency for the whole of that year. This consideration and others of the same kind prove the value of the budget as an indicator of what a library is doing, or can accomplish, and no library authority should neglect to have a useful record of this kind prepared annually and kept in view.

54. Local circumstances alter the whole conditions so materially in every place, that it was not found possible to prepare specimen budgets from existing financial statements. Indeed, the utter lack of uniformity would alone have prevented this had there been no other factors equally disconcerting. The figures given are more of the nature of suggestions than any-

Sec. 54] FINANCE, LOANS, ACCOUNTS, REPORTS.

| Items of Expenditure. | Income from Rate | £2,500. | £2,000. | £1,500. | £1,000. | £500. | £100. |
|--------------------------------------|------------------|---------|---------|---------|---------|--------|---------|
| | £3,000. | £ | £ | £ | £ | £ | £ s. d. |
| Buildings:— | | | | | | | |
| Lighting | 180 | 160 | 110 | 75 | 50 | 80 | 6 0 |
| Heating | 30 | 25 | 20 | 10 | 8 | 5 | 2 0 |
| Water | 10 | 8 | 6 | 8 | 2 | 1 | 1 |
| Fittings and Repairs | 40 | 30 | 22 | 20 | 10 | 5 | 8 0 |
| Cleaning and Materials | 30 | 25 | 18 | 15 | 8 | 4 | 4 |
| Rent | .. | .. | .. | .. | .. | 70 | 25 0 |
| Insurance | 12 | 10 | 8 | 6 | 5 | 3 | 0 5 |
| Books, etc.:— | | | | | | | |
| Books, Maps, Prints | 500 | 400 | 300 | 200 | 100 | 50 | 10 0 |
| Periodicals and Newspapers | 180 | 150 | 110 | 80 | 50 | 40 | 10 0 |
| Bookbinding | 110 | 90 | 70 | 50 | 30 | 15 | 2 0 |
| Salaries:— | | | | | | | |
| Librarian | 850 | 825 | 800 | 250 | 200 | 150 | 80 0 |
| Sub-Librarian | 175 | 168 | 160 | 125 | 100 | .. | .. |
| Senior Assistants | (1) 78 | (1) 60 | (1) 60 | 60 | .. | .. | .. |
| Junior | (8) 208 | (6) 160 | (5) 150 | (3) 78 | (3) 78 | (2) 52 | .. |
| Caretakers (20s., 25s., 30s. each) | (2) 180 | (2) 180 | (1) 78 | 65 | 65 | 52 | .. |
| Cleaners (5s. weekly each) | (4) 60 | (3) 39 | (3) 39 | (2) 26 | 18 | .. | 10 0 |
| Establishment Charges:— | | | | | | | |
| Stationery | 90 | 20 | 12 | 10 | 8 | 5 | .. |
| Printing | 15 | 50 | 20 | 15 | 8 | 6 | .. |
| Local Rates | 15 | 12 | 8 | 6 | .. | .. | .. |
| Taxes | 10 | 8 | 7 | 6 | 4 | .. | .. |
| Carriages and Travelling Expenses | 20 | 10 | 12 | 10 | 6 | 2 | 1 15 |
| Postages | 12 | 15 | 8 | 5 | 8 | 2 | .. |
| Miscellaneous Supplies | 20 | 15 | 12 | 10 | 8 | .. | .. |
| Loans Account:— | | | | | | | |
| Principal | 750 | 625 | 500 | 375 | 250 | .. | .. |
| Interest | .. | .. | .. | .. | .. | .. | .. |

FIG. 11.—Budget or Estimate of Annual Expenditure for Libraries of varying Incomes (Sections 53-54).

thing else, and simply give an idea of what is considered a fair distribution of varying incomes. The provision made for different services is based on actual results in several libraries, and, excepting salaries and loans, the estimates may be regarded as fair approximations to the usual expenditures. The salaries and loans are fixed at our own maximum in each case, but as junior salaries are mostly placed at minimum amounts, the total salaries bill will be found pretty near the average for the class of library treated. No account has been taken of any sums derived from incidental receipts such as fines, sale of catalogues, etc., which have been left as a kind of floating balance, available for the repayment of a loan for site, or to reinforce any item which may require increasing. Expenditure on account of museums, art galleries, lectures and similar departments is not provided for in our budget table, but branch libraries are contemplated for places with £2,000 income and upwards.

55. Contracts, Agreements, Requisitions.—Contracts for regular supplies should be renewed annually. The principal items of this kind are:—

Books, bookbinding, periodicals and newspapers, printing, stationery, cleaning materials.

Local sentiment is generally in favour of procuring all supplies locally, where possible, and when this can be done without absolute disadvantage to the library it is the most convenient course. Tenders can be invited either by public advertisement or on the nomination of members of committee and the librarian. To begin with, public advertisement is, perhaps, the fairest way; afterwards, quality of service and other considerations will decide. Specifications should be prepared and sent out according to requirements.

56. All specifications and contracts should be carefully preserved. The former should be entered up in a specification book, which need be but an ordinary foolscap folio blank book, ruled faint. Accepted contracts should either be filed in boxes or guard books, or copied into a contracts book similar to the specification book. Accepted estimates for occasional work should be fastened to the accounts. It is important to be able

Sec. 58] FINANCE, LOANS, ACCOUNTS, REPORTS.

to lay hands on any given document or its terms without the slightest delay. Unaccepted contracts and estimates, if not returned, may be filed in a folio guard book, or in boxes similar to those described in Section 242. All tenders for regular supplies and estimates for occasional work should be opened in committee, never by the librarian or any members of committee not in meeting duly convened, unless by special resolution of the committee. Envelopes, printed with the address of the library and having the words "Tender for ——" printed boldly in one corner, should be enclosed with all invitations for estimates to prevent the risk of accidental opening.

57. In connection with contracts it is important to note that Public Library Committees and officers are subject to the penal provisions of the "Public Bodies Corrupt Practices Act, 1889," 52 & 53 Vict., c. 69, in the event of bribes or commissions being given or received in connection with pending contracts or supplies. As this does not seem to be generally known, we quote the essential words of the Act:—

"Every person who corruptly solicits or receives, or agrees to receive, for himself, or for any other person, any gift, loan, fee, reward, or advantage, as an inducement to any member, officer, or servant of a public body, doing or forbearing to do anything in respect of any matter or transaction in which such public body is concerned; and every person who shall, with the like object, corruptly give, promise, or offer any gift, loan, fee, reward, or advantage to any person, whether for the benefit of that person or of another, shall be guilty of a misdemeanour. Any one convicted of such an offence shall be liable to imprisonment for two years, or to a fine of £500, or to both imprisonment and fine; and, in addition, be liable to pay to such public body the amount or value of any gift, loan, fee, or reward so received by him; and be adjudged incapable of holding any public office for seven years, and to forfeit any such office held by him," etc.

58. AGREEMENTS for leases, loans, joint use of libraries with adjoining authorities, or between committee and librarian or other persons, should be drawn up by a solicitor. Minor agreements may be drawn up by the library authority, but they should all be stamped with a sixpenny stamp if in connection with a consideration of £5 and over. The legal limits within which agreements between various kinds of library

authorities can be made are duly set forth in the various Public Libraries Acts, and, as these matters seldom arise in the course of ordinary library routine, there is no need to further consider the subject.

59. REQUISITION books or forms are used in a few libraries to enable the librarians to demand supplies from time to time. Where a librarian is in touch with his committee; where contracts for various supplies exist; and where a petty cash account is kept, we can only regard the system of requisitions as a useless formality which is bound to cause delays and inconvenience. Where no contracts exist, or where committees meet but once a quarter, the chairman should be empowered to authorise any supplies which are urgently required.

60. Assessment to Rates and Taxes.—The assessment of public library buildings to rates and taxes has been for long a burning question, and, though not finally decided, may be regarded as well on towards settlement. The limitation of the library rate to a penny in the pound has always been considered by library authorities a strong reason why all additional burdens on the meagre income raised thereby should be resisted. But all local authorities and assessment committees did not think likewise, and a good deal of friction resulted.

In 1843 was passed "An Act to exempt from County, Borough, Parochial, and other Local Rates, Land and Buildings occupied by Scientific or Literary Societies," 6 & 7 Vict., c. 36, under which a few public libraries obtained certificates of exemption from the payment of local rates, from the Registrar of Friendly Societies, as allowed by this Act. Some of these certificates were recognised by the rating authorities, others were ignored, and it was frequently maintained that a public library was not a scientific or literary society within the meaning of the Act. In 1896, however, a complete change took place as regards this point, by a decision of the House of Lords, which ruled that public libraries were literary societies or institutions for the purposes of the "Income Tax Act of 1842," under which such institutions were granted exemption from the payment of income tax. Although the case, brought by the Corporation of Man-

Sec. 61] FINANCE, LOANS, ACCOUNTS, REPORTS.

chester against the Surveyor of Income Tax for Manchester, did not directly refer to the Act of 1843, the decision that public libraries were literary institutions effected all that was necessary for the purpose of claiming exemption from local rates under the "Literary Societies Act of 1843". A full report of this case and decision is printed in *The Library* for 1896, in the *Times*, Law Reports and elsewhere. The effect of this decision was to remove any doubt from the mind of the Registrar of Friendly Societies, who has power under the Act to grant certificates exempting public libraries from the payment of local rates, and as a result many libraries obtained certificates, and now enjoy complete or partial exemption. It is not necessary to quote the Act of 1843, which can be obtained for one penny from the King's printers, and we shall therefore simply describe the procedure requisite for obtaining a certificate of exemption.

61. An application claiming exemption under the 1843 Act must be addressed to the Registrar of Friendly Societies at London, Edinburgh or Dublin, as the case may require. With this must be enclosed a copy of the rules and regulations of the library, signed by the chairman and three members of committee, and countersigned by the clerk or librarian. These rules must include the following, or others in similar terms:—

1. "The — Public Library is a society established for purposes of literature and science exclusively."

2. "The library is supported in part by a rate levied in accordance with the Public Libraries Acts, and in part by annual voluntary contributions of money and gifts of books and periodicals. The Library Committee shall not make any dividend, gift, division or bonus in money unto or between any of the members."

These two rules are absolutely necessary to a successful application, and, if not already incorporated, should be included by special resolution of the library authority before application is made. It is best to send printed copies of the rules, and it should be noted that three identical copies, all signed, must be sent. On these the registrar endorses his certificate, and sends one to the Clerk of the Peace for the district, one to the library

authority, and retains one. The form of certificate usually attached is as follows :—

It is hereby certified that this society is entitled to the benefit of the Act 6 & 7 Vict., c. 86, intituled "An Act to exempt from County, Borough, Parochial and other Local Rates, Lands and Buildings occupied by Scientific or Literary Societies".

Date.



The application should show that annual voluntary contributions of money, books and periodicals are received, but there is no direction laid down as to the amount of voluntary contributions which will pass muster. The point is somewhat vague, but it may be assumed that the amount received from gifts, subscriptions, sales, books, periodicals, etc., need not form a substantial proportion of the income. As the English Registrar accepts donations in kind as annual voluntary contributions, it is only necessary to value these to make up a respectable sum.

62. We understand that certificates will not be granted in cases where a charge for admission is made. Furthermore, it is doubtful if the exemption from local rates would be allowed by hostile local authorities for any occupied portions of library buildings. A caretaker's or librarian's residence would in all probability be separately assessed, if the certificate were otherwise recognised.

63. The House of Lords' decision already noticed also freed public library buildings from income tax, but it should be distinctly understood that inhabited house duty can be charged for the whole of a building, even if only partly occupied as a residence, when included under one roof, unless it can be shown that the library and residence do not communicate directly with each other.

Sec. 65] FINANCE, LOANS, ACCOUNTS, REPORTS.

64. Insurance.—Library buildings and their contents should be fully insured against fire. To ascertain insurable value take the cost of buildings at the contract price; furniture at the contract price; lending library books at 3s. 4d. per volume all over; and reference library books at 5s. per volume all over, and thus obtain a total. The policy will state these various items separately for purposes of insurance, but will likely charge a uniform percentage on all. 1s. 6d. per cent. is a fair charge in a good office, but insurances can be effected for as low as 1s. 3d. per cent. Library buildings form a safe risk, and unless in a case of temporary premises with bad surroundings, 1s. 6d. per cent. should be regarded as a maximum charge. Some offices return the premium once in five years or so by way of bonus. Insurance policies should be revised every few years to keep pace with the growth of the library. Paintings, valuable MSS. and rare books must be made the subject of special insurances. The same may be said of temporary exhibitions, especially of loan articles, which ought to be covered by a policy for the period of the show. Plenty of fire-buckets should be provided in public library buildings to cope with the first outbreak of fire. Hydrants, save in large buildings, are not necessary, on account of their cost and practical inutility. If a fire cannot be checked at its onset by means of buckets, it is time to ring up the fire-brigade.

65. Suggestions on Management.—It is well to keep a book or to provide forms to enable readers to make suggestions on the management of the library. Generally, such suggestions take the form of complaints, but it is a useful thing to allow free opportunity for the expression of public opinion. In some libraries separate books are kept for propositions of new books not in the library and suggestions on management. We prefer a simple form, on which the reader can make suggestions on management or of books. When these forms are made readily available, and are kept in public view, together with a locked box in which the slips can be lodged through a slit in the lid, they are much more effective as a means of drawing suggestions

than special MS. books which have to be asked for. A useful form of slip is the following :—

| |
|---|
| <p>LIBERTON PUBLIC LIBRARY.</p> <p>I beg to make the following suggestion (<i>if a book or periodical, please give publisher and price</i>):—</p> <p>.....</p> <p>.....</p> <p>.....</p> <p>.....</p> <p style="text-align: center;">Name.....</p> <p style="text-align: center;">Address.....</p> <p style="text-align: center;">Date.....</p> <p style="text-align: center;"><u>Please fold across and leave in "Suggestions" Box.</u></p> |
|---|

FIG. 12.—Suggestion Slip, 7" x 5".

A small locked box to contain these, and lettered on side "Suggestions," should be provided. If one of these boxes is placed in each important department of the library, readers will be encouraged to air their views. Even if nothing more valuable should be received than a complaint about a draught or the manner of the librarian, it is better than the dull indifference and apathy which are met with in libraries where readers are discouraged from taking any part in the administration. Occasionally some brilliant, if impossible, suggestions on management are received by means of these slips and boxes, and suggestions of desirable books can always be depended upon. Every means of interesting readers in the work of the library should be adopted, and this will be found a very effective method.

66. Annual Report.—The committee's annual report is the summary and crown of its labours, and should contain a full account of the work and operations of the library in all its departments. There is room for improvement in the form of library reports, and we would suggest as a reform in the right direction the excision of elaborate tables of issues, stock, etc.,

Sec. 66] FINANCE, LOANS, ACCOUNTS, REPORTS.

of central and branch libraries in their various departments. These can have interest for nobody, even when fully understood, and they can never convey so tersely and clearly the information which may be so easily summarised in a few brief paragraphs. After all, it is a matter of no importance to any one how many volumes a certain library issued in the month of May, 1900, and all preceding years for the past decade. When one sees a very large library report, crammed with pages of elaborate tables, it suggests a crafty plan to astonish the newspaper men, dazzle the local authority, and cause envy among neighbouring libraries, rather than a plain effort to describe the work and results of a certain period of activity. We plead, then, for plain and clear reports, free from comparisons with other libraries, and giving the main facts without the use of confusing statistical tables. The information which a library report ought to convey may be briefly indicated by the following suggested list of topics :—

Title-page.

List of members of committee and library staff.

Table of attendances of members of committee. (*See* Section 81.)

Committee's narrative report, based on the figures supplied in the succeeding librarian's report, or appendix of documents.

Librarian's report or appendix of documents on the following matters set out as below. In this the library is treated as *one* institution :—

STOCK.

| Class. | Central. | | Branches. | | Total. | | Grand Total. | |
|--------|------------|----------|------------|----------|------------|----------|--------------|------------|
| | Reference. | Lending. | Reference. | Lending. | Reference. | Lending. | Report Year. | Last Year. |
| A | 000 | 000 | 000 | 000 | 000 | 000 | 0000 | 0000 |
| B | | | | | | | | |
| C | | | | | | | | |
| D | | | | | | | | |
| etc. | | | | | | | | |
| Total | | | | | | | | |

Number of volumes added during the year, with proportions purchased and donated. Grand total purchased..... Do. donated..... Number of volumes worn-out and withdrawn. Other particulars in brief paragraph form.

ISSUES.

| Class. | Central. | | Branches. | | Total. | | Grand Total. | |
|----------|------------|----------|------------|----------|------------|----------|--------------|------------|
| | Reference. | Lending. | Reference. | Lending. | Reference. | Lending. | Report Year. | Last Year. |
| A | | | | | | | | |
| B | | | | | | | | |
| C | | | | | | | | |
| D | | | | | | | | |
| etc. | | | | | | | | |
| Total | | | | | | | | |
| Averages | | | | | | | | |

Columns for juvenile and other departments must, of course, be included, if they exist.

BORROWERS.

Total number report year and last year. Number holding extra or students' tickets.

Occupations (if thought necessary), sexes, ages. To be briefly summarised.

READING ROOMS.

Attendances at newsrooms, magazine rooms, etc.

List of donations.

Lists of periodicals and annuals (only if no other means of revising printed list is available).

Financial statement. (*See* Section 51.)

Memoranda relating to district, showing population, area, valuation, date when Acts adopted, date of opening building, other leading facts.

67. REFERENCE LIST OF AUTHORITIES:—

Chambers and Fovargue. Law relating to Public Libraries, 1899.

Credland, W. R. Rating and taxation of public libraries. Greenwood's Year Bk., 1897, p. 45.

Crunden, F. M. Executive department: general supervision. U. S. Educ. Rept., 1892-1898, v. 1, p. 795.

Pacy, F. Borrowing and rating powers under the Public Libraries Acts. L., v. 1, p. 182.

Davis, C. T. Fire prevention and insurance. Greenwood's Year Bk., 1900, p. 58.

Davis, C. T. Insurance of public libraries. L. W., 1899, p. 121.

Insurance: Discussion. Lib. J., 1893, Conf. no., p. 23.

Poole, R. B. Fires, protection, insurance. U. S. Educ. Rept., 1892-1898, v. 1, p. 724.

Crunden, F. M. Library Reports. Lib. J., 1890, p. 198.

For list of abbreviations see Section 88.

DIVISION II.

STAFF.

CHAPTER V.

LIBRARIAN.

68. Qualifications.—Like the prominent members of every other trade, profession or branch of learning, good librarians are born, not made. No amount of training or experience will create such natural gifts as enthusiasm, originality, initiative and positive genius for the work ; but training in sound methods will help to provide a passable substitute for natural aptitude. Experience alone will not prove equally valuable, because it may not have been associated in its course with training in effective methods, and consequently may only represent knowledge of an effete and inefficient class. If all library methods were identical, and of the same standard of advanced excellence, experience alone would equal special training ; but owing to the very wide difference between the methods of twenty or thirty years ago, and the more scientific methods of to-day, it is necessary to judge the experience of any librarian by the school in which he has been trained.

69. The physical qualifications of a librarian should include good health, freedom from any deformity, defect or incurable disease, and his or her age should not be less than twenty-five nor more than fifty. Between these limits the most active and intelligent officers are likely to be obtained for new appointments. Age is not so important in cases of promotion, as committees in such instances are guided by first-hand and accurate knowledge of capabilities. As regards the physical condition of librarians, it may be said generally that the same principles

which guide selection in business appointments should be the rule in all library appointments.

70. The mental attainments of a librarian should be judged mainly by their suitability for the duties to be performed. The degree of attainment differs in individuals, and it would be wrong to expect as many useful qualifications in a librarian receiving £100 per annum, as in one, with twenty times the responsibility, receiving £500 per annum, but there are certain broad principles which apply in varying proportions to every case, and these should be seriously considered by committees while appointments are being made. With due allowance for the size and wealth of the library, and the salary to be offered to the librarian, the following practical qualifications should be looked for and expected in every candidate:—

71. LIBRARIAN'S QUALIFICATIONS.

1. Previous training for at least three years in a library which is classified according to some scientific and exact system; and which publishes catalogues which can be produced as evidence of the quality of work performed.
2. A wide knowledge of English and foreign bibliography and literature, and an intimate and exact knowledge of the contents of modern books, especially those which are technical, scientific and historical.
3. Sufficient acquaintance with foreign languages to enable title-pages to be translated and understood with the aid of dictionaries. Ability to tell the beginning from the end of an Oriental book.
4. A knowledge of elementary book-keeping and accounts, together with some experience in ordinary business routine.
5. Practical acquaintance with the leading systems of exact classification, and the power to describe how they differ in notation.
6. Full knowledge of various methods of cataloguing, with a thorough grasp of the modern literature of the subject.
7. Experience in the management of assistants.
8. Practical knowledge of all modern systems of library working, including bookbinding, book purchasing, charging and maintenance.
9. Knowledge of modern periodical literature, and the management of newsrooms.
10. General culture, tact and courtesy.

Every candidate for a librarianship in a public library should be able to produce satisfactory proof that his qualifications cover most of the above points. In all other respects committees

must rely on their own sagacity. Before leaving the subject of qualifications, there are a few important matters which require notice.

72. *The appointment of a librarian should be the first step taken by a committee.* Numberless blunders have been committed in the past, through the mistaken policy of proceeding with buildings, methods and book selection before a chief officer was appointed. Any little amount which may be saved from the salary of the librarian is always lost by the adoption of faulty apparatus or plans, and in the end committees who work without the aid of a trained adviser are certain to spend many times more than the salary in all kinds of futile and expensive experiments. It is not only a great mistake to proceed without expert advice, but an utterly false economy in every respect.

73. *Only trained librarians should ever be appointed to chief posts.* Sometimes, for sentimental or local reasons, committees have committed the blunder of appointing chief librarians from the ranks of stickit ministers, unlucky schoolmasters, retired soldiers, minor journalists, unsuccessful booksellers, dilettante town councillors, or such-like remnants of the failures or superannuated in other walks of life, and the result has been in every case unfortunate. No untrained librarian is likely to attain more than the poorest or most commonplace results. There is just as much need for carefully trained and expert officers in modern library work, as there is in any other trade or profession which depends for its excellence on special knowledge. No committee of business men would ever dream of appointing a chemist, architect, medical officer, engineer, solicitor, or even a factory manager, from the ranks of the untrained and inexperienced, as has been so often done in public libraries. It is a good rule to insist that every candidate must have been trained for at least three years in a systematically classified public library, as suggested in our No. 1, Section 71. This is the only possible way of making sure that the candidate is acquainted with modern library methods.

74. Advertisements and Application Forms for Appoint-

ments.—Advertisements for librarians are usually inserted in the *Athenæum* (11 Bream's Buildings, Chancery Lane, London, E.C.), a weekly literary journal which is scanned by every librarian in the country. An advertisement appearing in it is, therefore, almost certain to come under the notice of every trained man in the profession. A useful form of announcement may be worded as follows:—

LIBERTON PUBLIC LIBRARY: CHIEF LIBRARIAN wanted. Age not to exceed 50. At least three years' training and experience in a public library employing systematic classification essential. Must be thoroughly versed in modern library methods. Salary to commence at £—. Application, accompanied by three recent testimonials, to be made on a special form, which may be obtained from the undersigned. All applications to be lodged with the undersigned not later than [allow three weeks]—. Second-class railway fares of selected candidates will be allowed. Canvassing will disqualify.

A. B. C., Town Clerk, or Clerk to the Committee,

An advertisement in these or similar terms, if inserted twice, will produce all the applications worth considering.

75. The practice of requiring all candidates to apply on a special form is a good one, and should be more generally adopted. It has the great advantage of securing uniformity in the information supplied, and it also enables a committee to ascertain the particulars considered most important. The following draft of a form may be suggestive to committees about to make an appointment:—

LIBERTON PUBLIC LIBRARY COMMITTEE.

[Address.]

APPLICATION FOR LIBRARIANSHIP.

The candidate is particularly requested to answer every question in full, and return to A. B. C. [address], by 12 o'clock on [date to be named], marked on outside of envelope, "Librarianship".

1. Full name.
2. Address.
3. Age next birthday.
4. Married or single.
5. No. of family if married.
6. Is your health good?
7. Have you any physical defect (deafness, lameness, etc.)?

8. Present occupation.
9. Length of service in present occupation.
10. Former occupations, if any.
11. Do you possess any of the following qualifications?—
 - Practical knowledge of modern literature.
 - Practical knowledge of scientific classification.
 - Practical knowledge of library planning.
 - Knowledge of accounts and book-keeping.
 - Experience in management of staff.
 - Practical knowledge of modern library management.
12. State system used in your library for the following departments, and which you would adopt if appointed here :—
 - Classification.
 - Printed catalogue.
 - Manuscript catalogue.
 - Book issue method.
 - Reference library method.
13. Have you originated any library device, or published articles on practical phases of library work?
14. Do you possess any degrees or certificates of an educational kind?
15. Have you made a special study of any particular subject?
16. When could you enter upon duty if appointed?

Selected candidates, when interviewed, should be examined on the questions scheduled above and on the qualifications specified in Section 71. A few questions by the chairman, based upon these, in addition to the independent suggestions of members of committee, will generally result in obtaining a very fair estimate of the qualifications of each candidate.

76. Salaries.—Owing to the limitation of the library rate and a general underestimate of the librarian's utility, salaries in municipal libraries are not very liberal. Excluding London and the largest provincial cities, the scale of remuneration may even be described as miserably inadequate. In the State, university and some of the endowed and proprietary libraries the salaries range much higher, taken all round. These appointments, however, especially such as the British Museum, India Office, House of Commons, the universities and similar institutions, are seldom offered for competition, and may be dismissed at once from the question. In public municipal libraries the salaries of chief librarians range from £600 down to £2 or £3 per annum,

with all kinds of intermediate rates. Some of the large London proprietary libraries, and many of the provincial libraries of a similar kind, also give salaries to about the same maximum ; but none of them reach the depths of a salary which works out at a fraction over 1s. 1½d. per week !

77. Generally speaking, Public Library Committees do not pay salaries at all commensurate with the service rendered, and the limitation of the library rate is not always the reason. The chief cause of the parsimony seems to be the application of the ordinary commercial method of getting as much value as possible for the smallest sum. This presses very hardly on librarians who are highly educated men, especially as the comparatively illiterate "buyer" of draperies or foodstuffs is treated like a prince in comparison, although his services to the public at large, or even his employer, are of insignificant value when placed side by side with those rendered by the librarian. Compared with practically every other branch of the municipal and educational service, the same unfair treatment is to be noticed. A schoolmaster will receive £400 per annum for looking after a single school containing perhaps 1,000 or 1,500 children. The chief librarian of a town of 423,000 inhabitants, issuing about 1,000,000 books annually, and superintending twenty-two branch libraries and all the newsroom, committee and accession work, receives the annual salary of £350 ! The same disparity is to be seen on every side.

78. While we admit that the penny rate is partly responsible for this state of affairs, there are still plenty of cases where justice is not done to the librarians even on existing means. If one library can pay a fair salary, another with an equal income can surely do the same. Of course there are circumstances which qualify the condition of affairs in every library, such as long service, the personality and accomplishments of the librarian, the work to be done on the income, etc. ; but in spite of these it ought to be possible to fix a scale which would be fair to the librarian and the institution over which he presides. A careful analysis of the income, population, work and salaries of the principal English and American libraries has

enabled us to produce a table which shows clearly the amount which a library can afford to pay for a good officer. This scale is considerably below the American one, but slightly higher than the English one up to library incomes of £6,000. Above that sum the salaries suggested approach more to the American scale.

79. TABLE OF LIBRARIANS' SALARIES WHICH SHOULD BE PAID BY LIBRARIES POSSESSING THE INCOMES UNDERNOTED.

| Library Annual Income from Rate. | Librarian's Salary. | Library Annual Income from Rate. | Librarian's Salary. |
|--|---------------------|--|---------------------|
| £ | £ | £ | £ |
| 20,000 | 800 | 1,600 | 260 |
| 15,000 | 700 | 1,500 | 250 |
| 10,000 | 600 | 1,400 | 240 |
| 8,000 | 550 | 1,300 | 230 |
| 6,000 | 500 | 1,200 | 220 |
| 5,500 | 475 | 1,100 | 210 |
| 5,000 | 450 | 1,000 | 200 |
| 4,500 | 425 | 900 | 190 |
| 4,000 | 400 | 800 | 180 |
| 3,500 | 375 | 700 | 170 |
| 3,000 | 350 | 600 | 160 |
| 2,500 | 325 | 500 | 150 |
| 2,000 | 300 | 400 | 130 |
| 1,900 | 290 | 300 | 90 |
| 1,800 | 280 | 200 | 60 |
| 1,700 | 270 | 100 | 30 |

For part of
time only.

By offering salaries according to the above scale library committees will be able to attract the best officers obtainable for the grade of library represented. They will also be freed from the *maximum* bogey, which is usually a very debatable policy wherever introduced. Very few officers who have once reached a maximum salary, especially when not very liberal, are likely to distinguish themselves by extra activity. An increase which proceeds with the growth of the library resources seems to be a very sensible policy, and is paralleled in commercial life by the case of the "buyer" already mentioned, whose advancement keeps pace with the growth of his "returns".

80. The question of advertising for a librarian at a salary considerably less than can be afforded by the scale is a somewhat difficult one. It is something for an officer to look forward to if he sees a succession of increases before him, and committees may also feel disposed to save in the early years while testing their man. On the other hand, the modified salary may not attract just the kind of man who would give the greatest value in service. For instance, suppose a committee administering a £4,000 library were to offer just £250 as a commencing salary. It would at once shut out all the capable men who were receiving from £260 and upwards, and the choice would be restricted to candidates receiving less than £250. At present this might not be a disadvantage, but afterwards, when salaries and attainments are more equalised, it might be a very serious matter indeed. If a commencing salary is fixed at a reduced rate, it should still be large enough to attract as many good candidates as possible, and near enough the maximum to be reached in not more than three years by increments of £20 or £25. The £4,000 library committee by offering £350 to commence with, rising by two steps of £25 to £400, would very largely increase their area of choice.

81. The only other point of importance arising out of the question of librarians' salaries is that of providing a residence on the library premises. This policy has been adopted in London more than anywhere else. It affects the question of salary to some extent, though not quite so much as has been claimed. A committee of a £4,000 library might argue that, by providing a good house in a valuable position, they are only entitled to give a salary of £300; the balance of £100 being represented by the house. The practical reply to this is that, a house under these conditions, although it could rent at £100 or even more, is just worth to the librarian exactly what he would be prepared to pay for house rent if he lived away from the library. Any allowance or deduction should accordingly be based upon this consideration. The policy of requiring a librarian to live on the premises is discussed at Section 148, but it may be said generally as regards the question that it resembles the old joke about

marriage: "Those who are in, want out; and those who are out, want in"!

82. Superannuation.—There is no general law at present under which public librarians can retire on a pension after a certain age has been reached. Some towns have made separate arrangements for the superannuation of all their officers, but even this is far from common. A Bill has been before Parliament for some years whose object is to procure for municipal officers the same regulations as to superannuation which are in force for poor-law officers, but this has not yet passed into law. The salaries question is affected in many cases by the rules in force in some localities, providing for contributions in aid of superannuation being deducted from the salaries of officers. The principal provisions of the proposed "Local Authorities Officers' Superannuation Bill" are as follows:—

RETIREMENT.—When officers attain the age of sixty, and have completed an aggregate service of forty years; or have reached the full age of sixty-five; or are incapacitated by mental or bodily infirmity, they may retire on the terms noted below.

CONTRIBUTIONS.—Officers with less than five years' service contribute 2 per cent. of the salary and emoluments received per annum. With more than five and less than fifteen years' service, $2\frac{1}{2}$ per cent. per annum. With over fifteen years' service, 3 per cent. per annum.

SCALE OF SUPERANNUATION.—One-sixtieth of the average amount of salary and emoluments during the five years ending on the quarter day which immediately precedes the day on which an officer ceases to hold office, with a maximum of forty-sixtieths. An additional allowance of years, not exceeding ten, may be added to the years of actual service at the discretion of the local authority. Thus, if an officer, after ten years' service, has received £100, £150, £200, £250 and £300 during the last five years, making a total of £1,000 and an average per annum of £200, he would be entitled to receive a pension for life of £36 6s. 8d., being ten-sixtieths of £200. To

this the local authority can add as many sixtieths up to ten as it may think proper or just.

83. Conditions of Librarian's Appointment.—There are several points requiring notice in connection with the conditions upon which librarians are appointed. It is not always usual to draw up a formal agreement, but if this is done it should be executed by a solicitor, and specify the principal obligations, terms and duration of the appointment.

1. In large libraries it is usual to stipulate that the librarian must devote the whole of his or her TIME to the duties of the office. This simply means that no other office can be held concurrently, but particularly a paid office. A librarian's private time can be devoted to any hobby he chooses, be it gardening, cycling, photography, literature, music or sport. Provided, always, such recreations do not render a librarian less fit for his public duty. Official time occupied in any work which has for its object improvement in professional knowledge should be allowed within reasonable limits. Attendances at meetings called for professional purposes, or visits to other places for the purpose of acquiring professional knowledge, would, we take it, be considered quite legitimate. Where a certain number of hours daily or weekly has been fixed the question of the disposal of a librarian's leisure time will not arise.
2. Notice of intention to DETERMINE AN APPOINTMENT might be stipulated for in an agreement. The usual practice is one month's notice on either side.
3. A public librarian who handles public money should be required to obtain security from a recognised guarantee office. The amount insured against will generally be fully covered by a sum equal to 10 per cent. of the annual income of the library. Thus, a library with an income of £2,000 should make £200 the insurable sum, as this will cover any possible defalcations of the librarian, who, under any circumstances, in such a library, can never handle more than about £60 or £70 in the course of one month. The premium for municipal officers averages about 5s. per cent., and, of course, the library authority should make the annual payments to keep the policy alive.
4. The VACATION allowed to librarians varies with the conditions of each place. In some cases five weeks are allowed, irrespective of the time occupied by conferences or other annual meetings. Usually three or four weeks are given, and this will be found generally as long as the average librarian can afford! As a rule, committees will not be found niggardly in this matter when they have an officer whom they can respect and trust. In American libraries a month is often allowed,

and in some cases much longer periods, as when librarians come to Europe to study library methods and receive mental and moral stimulus!

5. The only ANNUAL CONFERENCES of any importance in connection with public library work are those of the Library Association and the Museums Association. Practice differs as regards libraries sending delegates to the annual conferences of the Library Association. In some cases where a library is a subscribing member, and, in addition, the librarian is also a member in his own name, it sends a member of the committee and the librarian, and pays their expenses. In other cases the librarian alone is sent, and his expenses paid. In still other cases the librarian is allowed the time to attend, but has to pay his own expenses; while, sometimes, the chairman of committee attends, and either pays his own expenses or has them paid by the committee.

Every library which desires to keep abreast with modern ideas in library work should send its librarian to the annual conferences of the Library Association, and pay his expenses. All public libraries should join this association as institution members, and see that the librarian becomes a member, either at his own expense or at that of the committee. There is more knowledge and good obtained by a librarian coming into personal touch with other librarians during a conference week than can ever be achieved in a state of hermit-like seclusion. The sum spent on a library conference to insure a librarian's attendance is by far the most profitable investment a library committee can make in a single year.

Some doubt exists as to whether members of committee can be sent at the expense of the library rate, and, so far as parishes are concerned, it has been decided by the district auditors that they can not be sent unless at their own personal expense. Municipal boroughs have power to send committee delegates if so disposed, but the matter remains doubtful as regards Urban District Councils.

84. Duties of the Librarian.—The duties of a librarian practically cover every section of this *Manual*, and it is, therefore, needless to go over the same ground here. We will assume, however, that the librarian also acts as clerk to his committee, and proceed to specify a few of the more personal duties of a librarian. We have already recommended that a librarian should act as clerk, and we may now give some reasons why this course should always be taken. The librarian is the only official who holds all the threads of work and routine in his hands or who thoroughly understands the practical working of

the institution. By combining the functions he remains in touch with his committee, and can much better understand their views than if a second person acts as intermediary or interpreter. The plan is also more economical, as town clerks either take a salary for acting as clerk to the library committee, or else charge a proportion of office expenses to the library. Both courses are quite unnecessary. It is not desirable, when a library committee has obtained a complete or partial delegation of powers, to have its work controlled or interfered with by another municipal department. Even when a library committee remains but an ordinary committee of a local authority, it is not desirable for the town clerk to do more than depute a junior clerk to attend meetings for the sole purpose of recording minutes. The chairman and librarian should call all meetings and arrange all necessary business. It is too often overlooked that library committees are appointed to carry out special work under a special Act of Parliament, and that, in consequence, they are performing duties outside the ordinary routine of municipal work. We need only refer, in conclusion, to the unsatisfactory results which have been achieved in some places, through local authorities or library committees setting up a double executive control.

85. The following summary of the more important duties which come immediately within the province of the librarian comprises everything with which he has a direct personal concern:—

1. He must superintend and prepare all the business for the library committee, including summoning meetings, preparing agendas, checking accounts, compiling lists of books, preparing reports and taking minutes of proceedings.
2. He must attend all committee meetings, and such of the local authority meetings as may be fixed.
3. He must prepare all specifications for contracts, and bring forward in plenty of time all business which arises regularly, either monthly, quarterly or annually.
4. He should sign all orders and be responsible for all correspondence connected with the library. He should keep copies of all orders and important letters, as well as copies of any specifications or other documents.

5. He must fix the time, duties and daily work of the staff, and superintend and check their attendance and work in every department.
6. He must see that order is maintained among readers throughout the main building and branches, and that the rules are enforced within reason, and that the opening and closing of the library are done punctually.
7. He must carefully supervise the selection of books and periodicals for addition to the library, and examine all necessary lists, catalogues and reviews for that purpose.
8. He should personally check all cataloguing and classification work.
9. He should be prepared when called upon to aid readers, as far as possible, in any line of research, and should be easily accessible at all times when on duty.

86. There is a very useful "Library Remembrancer" published, which every librarian should possess. It consists of a card on which are printed all kinds of routine matters which are likely to arise in a library, together with other information. Metal pointers are provided which can be fixed on the margins of the card against any item requiring attention, and, when the remembrancer is hung prominently before the librarian, it serves as a ready reminder. The pointers can readily be moved to any part of the card by simply sliding them where wanted. The card also has a book scale for sizes, specimens of printing founts, list of useful publications, etc.

87. **THE LIBRARIAN'S LIBRARY.**—The following list of books represents the chief tools which every librarian ought to possess in addition to any others mentioned among the reference lists in other parts of this work. Those marked with an asterisk (*) are particularly desirable:—

- *Acland (A. H. D.) Guide to the choice of Books for Students and General Readers. London. 1891.
- *Adams (C. K.) Manual of Historical Literature. Third edition. New York. 1888.
- *Allibone (S. A.) Critical Dictionary of English Literature and British and American Authors. Philadelphia. 1859-1871. 3 vols.
- *— Supplement, edited by J. F. Kirk. 1891. 2 vols.
- Ames (J.) Typographical Antiquities. London. 1786-1790, 3 vols. (ed. by Herbert); or 1810-1819, 4 vols. (ed. by Dibdin).

- Blackburn (C. F.) Hints on Catalogue Titles, and on Index Entries. London. 1884.
- *Blades (Wm.) The Pentateuch of Printing. London. 1891.
- Bolton (H. C.) Catalogue of Technical Publications. 1665-1882. Washington. 1887.
- Book-Prices Current . . . edited by J. H. Slater. 1887-1898. London. *In progress.*
- Bowen (H. C.) Descriptive Catalogue of Historical Novels and Tales. London. 1882.
- Bowker (R. R.) and G. Iles. Readers' Guide in Economic and Political Science. New York. 1891.
- *Brassington (W. S.) History of the Art of Bookbinding. 1894.
- Brewer (E. C.) Readers' Handbook of Famous Names in Fiction, Allusions, References, etc. London. 1898. *Last edition.*
- *British Museum. List of Bibliographical Works in the Reading Room. *Latest edition.*
- *British Museum. List of Books of Reference in the Reading Room. *Latest edition.*
— *See also* Fortescue.
- Brown (James D.) Adjustable Classification for Libraries, with Index. Abstracted from "Manual of Library Classification". London. 1898.
- *— Guide to the Formation of a Music Library. (L. A. Series, No. 4.) London. 1893.
With Supplement in *Library World*, May-June, 1899.
- *— Hand-book of Library Appliances: the Technical Equipment of Libraries. (L. A. Series, No. 1.) London. 1892.
- *— Manual of Library Classification and Shelf Arrangement. London. 1898.
- *Brunet (J. C.) Manuel du Libraire. Paris. 1860-1865. 6 vols.
— Supplement. Paris. 1878-1880. 2 vols.
— Dictionnaire de Géographie, par Deschamps. Paris. 1870.
- *Bullen (G.) *ed.* Catalogue of Caxton Celebration. 1877.
- *Burgoyne (F. J.) Library Construction, Architecture, Fittings, and Furniture. London. 1897.
Burgoyne (F. J.) and J. Ballinger and J. D. Brown. Books for Village Libraries. (L. A. Series, No. 6.) London. 1895.
- *Burton (J. H.) The Bookhunter. Edinburgh. v.d.
- *Catalog of "A. L. A." Library. Five Thousand Volumes for a Popular Library, selected by the American Library Association . . . Washington (U.S. Bureau of Education). 1898.
(Catalogued according to Dewey and Cutter classifications, and in Dictionary form. Gives prices in dollars.)
- Chambers (George F.) Digest of the Law relating to Public Libraries and Museums, etc. Third edition. London. 1889.

- *Chambers (George F). Digest. New ed., with H. W. Fovargue. 1899.
- *Clegg (James) International Directory of Booksellers and Bibliophiles' Manual, including Lists of the Public Libraries of the World, etc. Rochdale. 1899. *Also other and later editions.*
- Copinger (W. A.) Supplement to Hain. *See* Hain.
- *Cotton (Henry) Typographical Gazetteer. Oxford. 1831-1866. 2 vols.
- Cousin (Jules) De l'organisation et de l'administration des bibliothèques. 1882.
- Cowell (Peter) Public Library Staffs. (L. A. Series, No. 3.) London. 1898.
- *Cushing (Wm.) Initials and Pseudonyms. New York. 1885.
- Anonyms. Cambridge, Mass. London. 1890. 2 vols.
- *Cutter (C. A.) Expansive Classification. Boston. 1891. *In progress.*
- *— Rules for a Dictionary Catalogue. Washington. 1876.
- Second edition. 1889.
- Third edition. 1891.
- *Dana (John Cotton) A Library Primer. Chicago. 1899.
- Deschamps. *See* Brunet.
- De Vinne (T.) The Invention of Printing. New York. 1877.
- *Dewey (Melvil) A Classification and Subject Index for cataloguing and arranging the books and pamphlets of a library. Amherst, Mass. 1876.
- Anon.*
- *— Tables and Index of the Decimal Classification. *Latest edition.*
- *— Abridged edition.
- *— *ed.* Library School Card Catalog Rules, with fifty-two *fac-similes* of sample cards . . . with bibliography of catalog rules by Mary S. Cutler. Fourth edition. Boston. 1892.
- *Dixon (Z. A.) Comprehensive Subject-Index to Universal Prose Fiction. New York. 1897.
- Dunning (A. S.) The Sunday School Library. New York. 1884.
- *Dziatzko (C.) Instruction für die Ordnung der Titel im alphabetischen Zettelkatalog der Königl and Universitäts-bibliothek zu Breslau. 1886.
- *Edwards (Edward) Memoirs of Libraries. London. 1859. 2 vols.
- Free Town Libraries, their Formation, Management and History. London. 1869.
- *English Catalogue of Books. 1835-1899. Issued in vols. and annual parts. *In progress.*
- *Faulmann (K.) Geschichte der Buchdruckerkunst. Vienna. 1882.
- *Fletcher (W. I.) Co-operative Index to Periodicals. New York. 1886.
- *— The Annual Literary Index. New York. 1898. *In progress.*
- *— Library Classification. Reprinted . . . from his "Public Libraries in America". Boston. 1894.
- *— Public Libraries in America. Boston or London. 1894.

- *Flint (Weston) *Statistics of Public Libraries in the United States and Canada.* Washington. 1898.
- *Fortescue (G. K.) *Subject Index of the Modern Works, British Museum. 1880-1895, 1902.* 4 vols.
- Fovargue (H. W.) *Adoption of the Public Libraries Acts in England and Wales.* (L. A. Series, No. 7.) London. 1896.
- Fovargue (H. W.) and J. J. Ogle. *Library Legislation. (1855-1890.) Public Library Manual, Part I.,* edited by J. Y. W. MacAlister and T. Mason. London. 1892.
- *Fovargue (H. W.) and J. J. Ogle. *Public Library Legislation. . . .* (L. A. Series, No. 2.) London. 1893.
- *Garnett (Richard) *Essays in Librarianship and Bibliography.* London. 1899.
- *Graessel (Arnim) *Grundzüge der Bibliothekslehre: Neubearbeitung von Petzholdt's Katechismus der Bibliothekenlehre.* 1890. New edition, 1902.
- *Manuel de Bibliothéconomie . . . Trad. de Jules Laude.* Paris. 1897.
- Graesse (J. G. T.) *Trésor de livres rares et précieux . . .* Dresden. 1859-1869. 7 vols.
- Grassauer (F.) *Handbuch für Oesterreichische Universitäts und Studien-Bibliotheken.* Vienna. 1888.
- *Greenwood (Thomas) *ed.* *Greenwood's Library Year Book.* 1897. *British Library Year Book.* 1900-01. London.
- Edward Edwards. London. 1902.
- *Museums and Art Galleries.* London. 1888.
- * — *Public Libraries: a history of the movement, and a manual for the organisation and management of rate-supported libraries.* Fourth edition (revised). London. 1891.
- Second edition. London. 1887.
- Third edition. London. 1890.
- * — *Sunday School and Village Libraries.* London. 1892.
- *Griswold (W. M.) *Descriptive list of novels and tales.* Cambridge, Mass. 1890-1892. 6 parts.
- (American, British, French, German, Italian and Russian Novels.)
- *Gross (C.) *Sources and Literature of English History . . . to 1485.* London. 1900.
- *Guild (Reuben A.) *Librarian's Manual: a treatise on bibliography, comprising a list of bibliographical works.* New York. 1858.
- *Haferkorn (H. E.) and P. Heise. *Handy Lists of Technical Literature.* Milwaukee. 1889.
- *Hain (L.) *Repertorium Bibliographicum . . .* Stuttgart. 1826-1888. 4 vols. Indices by Burger, 1891. Supplement by W. A. Copinger. London. 1895-1898. 2 vols.

- *Halkett (Samuel) and John Laing. Dictionary of the Anonymous and Pseudonymous Literature of Great Britain. Edinburgh. 1882-1888. 4 vols.
- *Horne (Thomas H.) Introduction to the Study of Bibliography. London. 1814. 2 vols.
- Humphreys (H. N.) History of the Art of Printing. 1868.
- *Iles (George) Annotated Bibliography of Fine Art. By R. Sturgis and H. E. Krehbiel. Boston. 1897.
- *International Conference of Librarians' Transactions, London. 1877. London.
- *— Chicago. 1898. Bureau of Education, U. S. Report 1892-1898. Vol. 1.
- *— London. 1897. London. 1898.
- *Jacobi (Chas. T.) On the Making and Issuing of Books. London. 1891.
- *Kroeger (A. B.) Guide to . . . Reference Books. Boston. 1902.
- *Langlois (C. V.) Manuel de Bibliographie historique. Paris. 1901.
- *Larned (J. N.) ed. The Literature of American History . . . Boston. 1902.
- *Leypoldt (A. H.) and G. Iles. List of books for girls and women. Boston. 1895.
- *Library: a magazine of bibliography and library literature. Edited by J. Y. W. MacAlister. 1889-1898. 10 vols.
— New series. 1899. *In progress.*
- *Library Assistant. London. 1898. Vol. 1. *In progress.*
- *Library Association. Monthly Notes. 1880-1888. 4 vols.
- *Library Association Record. London. 1899. *In progress.*
- *Library Association Transactions and Proceedings of Annual Meetings. 1878-1894.
- *Library Association Year Books. 1898-1908. *In progress.*
- *Library Chronicle. London. 1884-1888. 5 vols.
- *Library Journal. New York. 1876. *In progress.*
- *Library World. London. 1898. *In progress.*
- *Linderfelt (Klas A.) Eclectic Card Catalog Rules. Author and title entries. Based on Dziatzko's "Instruction" compared with the rules of the British Museum, Cutter, Dewey, Perkins, and other authorities. Boston. 1890.
- *Lowndes (Wm. T.) Bibliographer's Manual of English Literature. London. 1857-1864. 6 vols.
- *Macfarlane (John) Library Administration. London. 1898.
- *Macgillivray (E. J.) The Law of Copyright. London. 1902.
- *Maire (Albert) Manuel pratique du Bibliothécaire. Bibliothèques publiques, bibliothèques universitaires, bibliothèques privées . . . Paris. 1896.
- Mayor (J. B.) Guide to the Choice of Classical Books. London. 1885-1896. 2 vols.

- *Ogle (John J.) *The Free Library: its history and present condition.* London. 1897.
- Panzer (G. W.) *Annales Typographici . . .* Nurnberg. 1798-1808. 11 vols.
- Perkins (F. B.) and L. E. Jones. *The Best Reading; hints on the selection of books.* New York. 1872-1895. 4 vols.
- *— *A Rational Classification of Literature for shelving and cataloguing books in a library, with alphabetical index.* San Francisco. 1882.
- *San Francisco Cataloguing for Public Libraries: a manual of the system used in the San Francisco Free Public Library.* San Francisco. 1884.
- *Petzholdt (Julius) *Bibliotheca Bibliographica.* Leipzig. 1866.
- *— *Katechismus der Bibliothekenlehre.* 1856.
- *Plomer (H. R.) *Short History of English Printing.* London. 1900.
- *Pollard (A. W.) *ed.* *Books about Books.* Series. *All.*
- *Poole (W. F.) and W. I. Fletcher. *Index to Periodical Literature (to 1881).* Third edition. Boston. 1882.
- *Supplements.* 1882-1896, 1901. Boston. 3 vols. *In progress.*
- Power (John). *Handy Book about Books.* London. 1870.
- Prideaux (S. T.) *Historical Sketch of Bookbinding.* London. 1898.
- Proctor (R.) *Index to the early printed books in the British Museum . . . to 1500.* London. 1898-1899. 4 vols.
- *Public Libraries. 1896. *In progress.* Chicago.
- *Public Libraries in the United States of America, their history, condition, and management. Special Report, Department of the Interior. Bureau of Education. Washington. 1876.
- Quérard (J. M.) *Dictionnaire des Ouvrages pseudonymes et anonymes de la littérature Française; 1700 to 1845.* Paris. 1846. 8 vols.
- *Quinn (J. Henry) *Manual of Library Cataloguing.* London. 1899.
- *Reference Catalogue of Current Literature. 1874-1898. *Issued irregularly every few years.* *In progress.*
- *Reyer (Ed.) *Entwicklung und Organisation der Volksbibliotheken.* Leipzig. 1893.
- *Richardson (Ernest C.) *Classification, theoretical and practical.* I. The order of the sciences. II. The classification of books. Together with an appendix containing an essay towards a bibliographical history of systems of classification. New York. 1901.
- Rogers (W. T.) *Manual of Bibliography.* London. 1891.
- *Rouveyre (E.) *Connaissances nécessaires à un Bibliophile.* Fifth edition. Paris. 1899. 10 vols.
- *Sargant (E. B.) and B. Whishaw. *Guide Book to Books.* London. 1891.
- *Sargant (John F.) *Reading for the Young.* A classified and annotated catalogue. Boston. 1890.
- Slater (J. H.) *The Library Manual.* Third edition. London. 1892.

- Smith (Lloyd P.) On the Classification of Books: a paper read before the American Library Association, May, 1882. Boston. 1882.
- *Sonnenschein (W. S.) The Best Books: a reader's guide to the choice of the best available books. London. 1887-1894. 2 vols.
- *— Reader's Guide to Contemporary Literature. London. 1895. (*Supplément to above.*)
- *Stein (Henri) Manuel de Bibliographie Générale. Paris. 1897.
- *Vallée (L.) Bibliographie des Bibliographies. Paris. 1888-1887. 2 vols.
- *Watt (Robert) Bibliotheca Britannica: a general index of British and Foreign literature. Edinburgh. 1824. 4 vols.
- *Wheatley (Henry B.) How to Catalogue a Library. London. 1889.
- *— How to Form a Library. London. 1886.
- Prices of Books, an inquiry into the changes in the price of books which have occurred in England at different periods. London. 1898.
- Whitney (J. L.) Modern Proteus; list of books published under more than one title. New York. 1884.

88. LIST OF ABBREVIATIONS OF TITLES OF JOURNALS, ETC. :—

Int. Con. = International Conference Transactions, 1897.

L. = Library (two series).

L. A. = Library Assistant.

L. A. R. = Library Association Record.

Lib. J. = Library Journal.

L. W. = Library World.

P. L. = Public Libraries.

89. REFERENCE LIST OF AUTHORITIES :—

- Being a Librarian. Symposium on difficulties, qualifications, etc., of librarianship, by American librarian. Lib. J., 1890, pp. 202, 281, 264, 294, 380.
- Fletcher, W. I. The librarian: his work and his training for it. *See his* "Public Libraries in America," p. 80.
- Hayward, A. L. Training of a Librarian. Lib. J., 1892, p. 478.
- Plummer, Mary W. Training for Librarianship. Lib. J., 1901, p. 317. (*Chiefly on American library schools.*)
- Relation of Trustees and Librarian (American). P. L., 1899, p. 368.
- Sharp, K. L. Librarianship as a profession. P. L., 1898, p. 5.
- Thompson, W. O. Librarianship as a profession. P. L., 1900, p. 415.
- For list of abbreviations see Section 88.*

CHAPTER VI.

ASSISTANTS.

90. Applications.—The same principles which guide in the selection of a chief librarian should govern the choice of public library assistants. All vacancies should be publicly advertised either in the *Athenæum* as before, or in the local newspapers, or both, stating requirements as regards age, salary, etc., and in the case of junior assistants, stating that an examination in certain elementary subjects of knowledge would be held, at which candidates must sit. An application form is not necessary for minor appointments, but library committees should insist upon a fair standard of education as a vital condition of any appointment. Librarians and sub-librarians are very frequently promoted from the junior staff, and, unless general knowledge and intelligence are regarded as essential conditions, such appointments are certain to disappoint both committees and public if the raw material is not selected carefully to begin with. In a large number of cases assistants are simply thrust into positions, for which they are absolutely unfit, by the influence of members of the library committee. It is an unfair abuse of a position of trust to show preference in this manner, and, before proceeding to make any appointment, Public Library Committees will do well to pass a binding resolution in the following terms: "All appointments on the library staff shall be publicly advertised, and candidates for assistantships must pass an examination in history, arithmetic and geography, the three who pass highest being selected to interview the committee, who shall choose one to fill the vacancy".

91. Examinations.—It is a matter of great importance for

a library committee to appoint only well-educated and intelligent assistants. Unless this is done always, both the library and the public will suffer. Nothing is more exasperating to intending readers than to be served by some youth who is ignorant of the most elementary subjects in general knowledge. For these reasons a preliminary examination which shall weed out the most illiterate of the candidates is highly desirable. The examination need not be very elaborate, but it should be thorough. The papers should be drawn in such a way as to form a test of each candidate's handwriting, spelling and composition. The History paper should include at least four questions which deal with English literature, and the Geography one should not be confined to the United Kingdom. Arithmetic need not go beyond the calculation of averages, percentages, etc., and bills of parcels. Four or six questions should be put in every subject, according to the time allowed, and a maximum of four marks should be given for each correct answer. An hour will generally be sufficient for three papers with four questions each, as this allows five minutes per question. An extra half-hour may be allowed for the six-question papers. In assessing papers allow full marks for every correct answer, but nothing for wrong or uncompleted answers. A mark or two may, however, be given in the History and Geography papers for answers which are partly correct. Deduct from the total marks any number which seems fair for bad spelling, bad grammar or poor handwriting. The three candidates who gain the most marks after any deductions are made should then be summoned to meet the committee. The examination should be conducted by the librarian, with any member or members of the committee appointed to assist him.

92. Examinations are held by the Library Association in London and other centres in Bibliography, English Literature, French Literature, Library Management, Library Legislation, etc., but they are not suitable for the purpose of aiding selection for first appointments. But any candidate for a senior post requiring knowledge of practical library work, who possesses

one of the Library Association's certificates, should be selected for interview as a matter of course. Committees should make certain, however, that the candidate possesses a complete certificate for the whole of a subject or subjects, and not simply an interim note showing that he or she has passed in a certain department of a subject. Assistants who are already appointed to positions in libraries should be encouraged to study for the Library Association examinations, and also to attend the summer schools and classes organised by the Association and its branches. Some library authorities pay the fees of their assistants to enable them to attend such educational classes, and, in addition, grant them the necessary time. This action is worthy of imitation.

93. Duties and Training.—Assistants should have their duties so arranged as to give ample opportunity for learning every branch of library work. Unfortunately this is not a recognised principle either in the United Kingdom or the United States. In many of the larger libraries the work is arranged in departments, Reference, Lending, Juvenile, Branch, Accession, Cataloguing, Registration, etc., and assistants who get fixed in one or other of these departments are likely to remain for a long time, to the great prejudice of their general education in library work. In common fairness to the assistants who give up their chance of more lucrative work to devote themselves to librarianship, full opportunity should be afforded them of gradually learning every department of the work, not in a period of five to ten years, but within a much shorter time. The assistant who is kept at accession or registration work for several years misses his or her chance of becoming acquainted with other important departments; while those who are continually doomed to branch library service not only lose all chance of learning, but all hope of promotion. The work of a large library staff should be so arranged as to give each assistant an opportunity of taking part in every branch of work in rotation. It may be more difficult to arrange in some libraries than in others, but whatever the difficulties they should be faced, because it is the first duty of a librarian to

make his staff efficient and carefully train them in the details of their work, just as if they were premediated apprentices, in order to fit them for the position of chief librarian which they aspire to occupy in their turn. The arguments in favour of fixed duties for members of a staff should not be allowed to weigh against the claims of assistants to complete education in every department of work. As the duties of library assistants comprise practically every kind of work or process described in this book, save buildings, etc., it is not necessary to recapitulate them here. Naturally the duties must differ in libraries according to their size and circumstances, and no hard and fast rules can be laid down.

94. Work Book.—It is a good plan to use a work book or duty book, in which the daily duties of each assistant can be entered. By means of such a book it is easy to change the work about, in order to give every assistant an opportunity of doing everything in turn; and it is necessary because of the changes worked on the composition of the staff by the time-sheet. A good form of work book is shown in the ruling below. The names or numbers of the assistants are written or printed in the margin, and against these the particular duty, or set of duties, to be performed that day are written. This book is generally made up by the sub-librarian in large libraries, and checked by the librarian. In small libraries the librarian can write up this record daily. Apart from its value as a simple means of distributing and fixing duties, it makes a capital record of visitors or callers, errors, absences of staff, progress of certain pieces of work, checks of various kinds, and may even be used as a staff time-book. The following form is strongly recommended as a complete guide to the work of a library and a check upon results, in a very handy form. For convenience' sake the assistants are numbered in order of seniority.

← 9" →

Date.....

| Time-Sheet. | | | | | | Daily Checks. | | |
|-------------|------|------|------|------|------|---------------|-------------------|----------------|
| | Arr. | Dep. | Arr. | Dep. | Arr. | Dep. | Department. | Initial. |
| 1 | | | | | | | a Reference | |
| 2 | | | | | | | b Lending | |
| 3 | | | | | | | c Reading Room | |
| 4 | | | | | | | d Juvenile | |
| 5 | | | | | | | e Overdue Change | |
| 6 | | | | | | | f Charging System | |
| 7 | | | | | | | g Change (money) | |
| 8 | | | | | | | h | |
| 9 | | | | | | | j | |
| 10 | | | | | | | k | |
| 1 | | | | | | | | New Orders. |
| 2 | | | | | | | | |
| 3 | | | | | | | | |
| 4 | | | | | | | | |
| 5 | | | | | | | | |
| 6 | | | | | | | | |
| 7 | | | | | | | | |
| 8 | | | | | | | | |
| 9 | | | | | | | | |
| 10 | | | | | | | | |

1 1/2"

NOTES.—[Callers, Complaints, Errors, Lost or Found Property, etc.]

FIG. 13.—Staff Work Book (Section 94).

95. The method of using this book is very simple. If there are ten assistants or under one page only is used, each member of the staff receiving an appropriate number. If there are more than ten assistants two pages must be used, the numbers on the second page having the figure 1 prefixed to them, and the 10 being altered to 20. Thus page 2 will appear as 11, 12, 13, 14,

etc. If there are more than twenty assistants a third page can be used, the existing numbers having 2 prefixed as before.

Each assistant on arriving or departing enters on the "Time-Sheet" his or her exact time in the spaces reserved, beginning the day with the first column. The assistants who check and tidy *a* to *d* in the mornings write their initials opposite the particular duty, while those who attend to the charging system, date stamps, overdues and cash for change also initial the item, the amount of change being stated. Against each assistant's number is written his or her duties for the day. The first page or pages of the work book should be reserved as a key, and the names of the assistants should be written against the numbers which represent them. The column "New Orders" is for the librarian to enter any new instructions for all the staff. These should be entered briefly in red ink from the bottom towards the top of the page. The NOTES lines will receive all items specified and any other notable incidents occurring in the course of each day, such as "Break down of Electric Light," "Drunk man expelled," etc. The work book must be kept in *one* recognised place, and every assistant should be held responsible for entering up his own notes and time. Any note of a general kind must be entered by the senior officer present on duty. The work book should be submitted to the librarian every morning.

96. Checks on Work.—If the work book is kept properly and well looked after by the librarian, no other check is required. In some libraries the assistants have to pencil their numbers against every piece of work performed either in a special book or on a card, but this seems an irksome addition to duties already sufficiently heavy. Rubber stamps of a special kind, with the assistants' numbers or differently coloured inks, are also used for tracing errors at the issue desk in some libraries; but all these elaborate checks for fixing responsibility have little effect in inducing extra carefulness. If they were effective and worth the trouble of maintaining, we should be only too glad to recommend them, but neither rubber stamps nor elaborate check-cards will eradicate the human tendency to

err. There is little difficulty in detecting a habitually or wilfully careless assistant, and when this is done, a month's notice is a more effective remedy than a mere mechanical means of, perhaps, occasionally detecting a delinquent. There is one form of mechanical or physical check, however, which should have a place in every busy library. For want of a better name we shall call it an "ORDERLY BOARD". Its purpose is to collect in one recognised place all the little odds and ends of matters which arise to cause inquiry. For example—Assistant No. 1, after a spirited encounter with a delinquent borrower, is promised payment, sometime, of the penny fine which was the cause of the dispute. No. 1 goes off duty, and while he is away the delinquent borrower returns, and is confronted by assistant No. 5, who is ignorant of the affray. The encounter either takes place all over again, or the borrower pays up, leaving No. 5 to find out as best he may how the matter stands. Now, if an orderly board is kept, No. 5 could refer to it and get to know immediately all about the affair. There are many little points of this sort which require classification and referring to one particular place, and the orderly board does something to accomplish all this. The diagram opposite shows better than words the kind of appliance meant, and the various items of information which it gives. It consists, as will be seen, of a series of strong clips mounted on a board, together with racks and boxes as shown in Fig. 14.

97. Hours.—According to the *British Library Year Book*, 1900-1901, the working hours of library assistants in British public libraries range from forty-two to sixty-six hours weekly. As all kinds and sizes of libraries are included in this comparison, and libraries of similar means and circumstances are to be found at both extremes, it is obvious that a more uniform method of fixing hours should be adopted. Why should a library which has practically the same income, hours of opening, staff and amount of issues, etc., as a similar library elsewhere, find it necessary to work its assistants sixty-six hours a week, or eleven hours a day, when, at the other library, the same duties can be performed on forty-two hours a week,

or seven hours a day? The two libraries which are here compared are balanced almost exactly. The one which works its

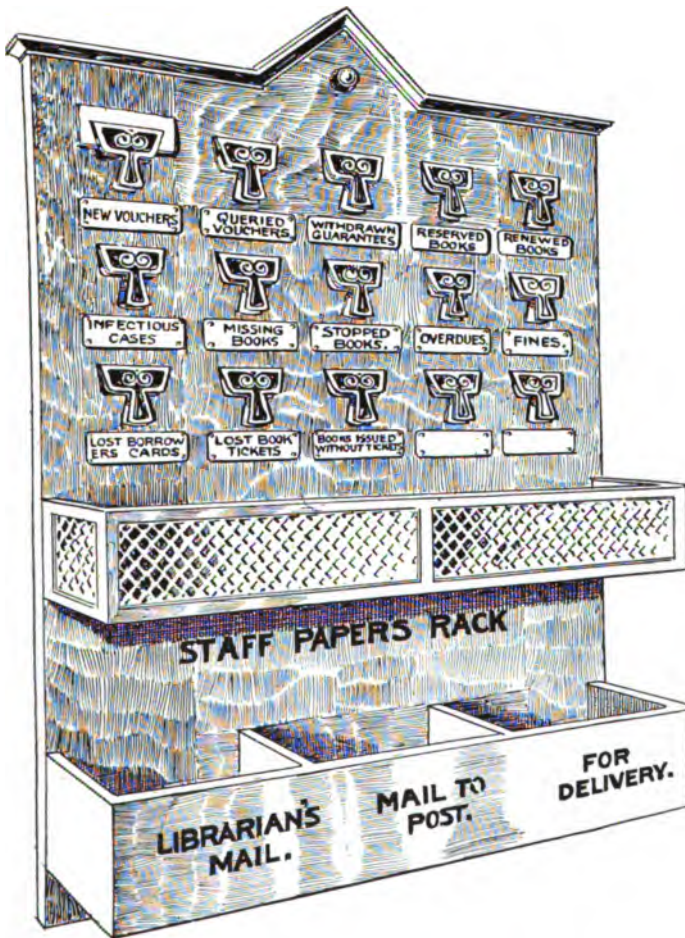

FIG. 14.—Staff Orderly Board, 3' x 3' (Section 96).

staff the shorter hours has one more assistant, but this is discounted by the fact that the library is open more hours weekly, and does the same work on a smaller income. There seems

no good reason why one library should not be able to treat its assistants the same as they are treated in other libraries of the same kind. The long and much-spread hours of public libraries, extending from early morning till late at night, require a sufficient staff to be in attendance throughout the whole period of twelve or fourteen hours, as the case may be. This leads to much broken time on the part of the staff, and to their duties being continued over the whole day. To keep assistants in condition and interested in their work, it is necessary that their hours should be short, as some compensation for many late nights and broken hours of duty. An average of eight hours a day, or forty-eight hours a week, should be regarded as a maximum, but forty-two hours a week, or seven hours a day, is even a better average. Assistants should have time for reasonable recreation and for study, and their hours ought to be arranged as far as possible independently of the library hours of opening. That is to say, the public should not be penalised by having their libraries closed at odd times and at inconvenient periods for the mere sake of shortening the hours of a few assistants; while, on the other hand, the staff should not be punished by being kept so short-handed and badly arranged as to materially interfere with the most important matter of making the library publicly accessible for as long a period daily as possible. (See Section 408.) There is no real connection between staff and library hours in large towns, and it is only in the smaller places that any difficulty need be experienced. No department of the library of a large town should ever be closed for a whole or half a day in order to give the assistants a weekly half-holiday. This can easily be done otherwise by letting a certain assistant or number of assistants off on different half-days in rotation throughout the week. It is not a very wise plan to select the shopkeepers' half-holiday for the library closing day, as is done in some places, thereby deliberately excluding hundreds of citizens from the benefits of the library for the sentimental reason that three or four library assistants must have a half-holiday. Let the staff have every consideration, even to a greater extent than at present, but do not let this interfere with

the service and convenience of the public. As we have just said, there is no reason why the assistants' time should be a factor in the general question of library hours, and the weekly half-holiday need not interfere either. In very small places, where the libraries can only be opened for a few hours daily or weekly, matters are entirely different, but we believe that this question is not one which affects any library with an income of £500 per annum and over.

98. *Time-Sheet*.—If a staff time-sheet is carefully constructed it will do away with a great deal of the difficulty of keeping a library open for a long series of hours daily with a small number of assistants. The worst feature of library service is the late nights, and very few places can arrange to give more than two early nights weekly. To give three or four early nights weekly would practically mean a duplicate staff, and this is not likely to be forthcoming with the present rate limitation, not to speak of the over-economical manner in which the average committee view questions of this kind. Some time ago the *Library World* (v. i., p. 233) published a description, with a ruled example, of a special card method of displaying an adjustable time-sheet in placard form. This is as practical and useful as any we have seen. The cards are ruled with vertical lines, representing hours and half-hours throughout the day. The assistant's numbers are printed down one margin, and their different times are represented by horizontal lines ruled across the hour lines by the librarian, or whoever draws up the sheet. An example of a card partly ruled to show a day's time for a staff of twelve assistants is given on the next page. The advantages of this system are that a single day can be altered without affecting any of the others; the cards are cheap, and are prepared with most of the ruling done; they can be used for staffs of any size; when placed in a special wooden rack the whole of the staff time for a week can be shown at a glance, with full details regarding each assistant.

99. *Vacation*.—The time granted for the annual holidays of assistants is generally a fortnight, but it varies in different places according to circumstances. A week or ten days is not

sufficient for the necessary rest and change, and a fortnight should be allowed in all cases, without deduction of time or wages. A sub-librarian should be allowed at least sixteen days for annual vacation, or if the chief gets a month, he should have twenty-one days.

100. Salaries.—The library assistants of the United Kingdom are not paid on a scale commensurate with the value of their services to the country, and this is but another case of the

| | 8 | 9 | 10 | 11 | 12 | 1 | 2 | 3 | 4 | 5 | 6 | 7 | 8 | 9 | 10 | |
|------------------|---|---|----|----|----|---|---|---|---|---|---|---|---|---|----|--|
| 1 | | | | | | | | | | | | | | | | |
| 2 | | | | | | | | | | | | | | | | |
| 3 | | | | | | | | | | | | | | | | |
| 4 | | | | | | | | | | | | | | | | |
| 5 | | | | | | | | | | | | | | | | |
| 6 | | | | | | | | | | | | | | | | |
| 7 | | | | | | | | | | | | | | | | |
| 8 | | | | | | | | | | | | | | | | |
| 9 | | | | | | | | | | | | | | | | |
| 10 | | | | | | | | | | | | | | | | |
| 11 | | | | | | | | | | | | | | | | |
| 12 | | | | | | | | | | | | | | | | |
| STAFF TIME CARD. | | | | | | | | | | | | | | | | |

FIG. 15.—Staff Time Card for one day (Section 98).

cheese-paring economy which has to be practised owing to the insufficiency of funds imposed by the library rate limitation. In some towns library assistants, performing duties requiring a considerable degree of intelligence and education, are paid less in name of wages than shopkeepers' errand-boys. Only in a very few places are anything like fair wages paid, and of course it follows that, in a large number of cases, assistants—boys particularly—are not only difficult to obtain, but they are not, as a rule, so fit for their duties as the public require. Any

intelligent lad will prefer a business career giving some hope of advancement, to one which holds out hardly any prospect of earning a living wage. This difficulty of obtaining well-educated boys of fifteen years of age and upward, who will undergo the necessary training for library work at the small pay offered, is one which is becoming more and more pronounced every year, especially in large towns, where plenty of more remunerative work can be had. The inevitable result of this will be that, unless the rate limitation is removed, public libraries will be driven to employ girls, a course to which, at present, many committees and librarians are loath to commit themselves. The commencing salaries paid to junior assistants in British public libraries range from 5s. weekly, or £13 per annum, to 10s. or 15s. weekly; £26 to £39 per annum. The commencing salaries paid to senior assistants range from 8s. weekly to 25s. weekly, or £65 per annum. The ages of juniors may range from sixteen to twenty, and of seniors from twenty-one and upwards. Sub-librarians receive from £50 to £175 per annum, and occasionally more in some of the larger libraries, when long service is recognised. It is difficult to fix a scale of salaries for any grade of library assistant, because local conditions and personal abilities count for so much. Generally, we should say that a sub-librarian of undoubted ability should receive half as much as the chief librarian of his own library, although it may not be necessary to commence at such a high rate. It is certainly not fair to those holding the responsible position of sub-librarian, that while the chief librarian is receiving £400 or £500, the deputy should only get £90, £100 or £150. In every case where a sub-librarian is expected to act as substitute for his chief, he ought to receive as a maximum salary half of what is being paid to that official.

101. In small libraries grades of rank seem needless. Seniority is best understood by length of service and the corresponding rate of pay, than by arbitrary divisions or rank. In large libraries it may be more convenient to have grades, so as to fix suitable maximum salaries for juniors and seniors. A

junior assistant is, we assume, a beginner or probationer of from fourteen to sixteen years of age, corresponding to the old apprenticeship stage which formerly ruled in trades. A senior who may be twenty-one and upwards is the stage corresponding to a journeyman; while a sub-librarian may be likened to a foreman or overseer. A scale of salaries for beginners and more advanced assistants is appended. It is based upon the salaries paid in several libraries, and may be regarded as a fair compromise between the meagreness of necessity imposed by the rate limitation, and the salaries which can be paid by all libraries with over £1,000 per annum.

102. SUGGESTED SCALE OF SALARIES FOR ASSISTANTS:—

| | |
|------------------------|-----------------|
| JUNIORS.—1st year, £26 | or 10s. weekly. |
| „ 2nd „ 31 | 4s. „ 12s. „ |
| „ 3rd „ 36 | 8s. „ 14s. „ |
| „ 4th „ 41 | 12s. „ 16s. „ |
| „ 5th „ 46 | 16s. „ 18s. „ |
| SENIORS.—1st „ | 50 |
| „ 2nd „ | 60 |
| „ 3rd „ | 70 |
| „ 4th „ | 80 |
| „ 5th „ | 90 |
| „ 6th „ | 100 |

These salaries, whether paid weekly or monthly, should not be subject to any deduction on account of absences from illness, holidays or other causes. The annual increases should only be granted provided the report and recommendation of the chief librarian is satisfactory. Failing a favourable report on conduct, an increase should be withheld. No assistant should be allowed to entertain the belief that increases of salary are automatic, and not dependent upon good behaviour and intelligence. It is a good plan to arrange for the whole of the staff increases to become due on the same date, so that they can all be considered and revised at one meeting of the committee.

103. Sub-Librarian.—A sub-librarian may be described as the officer who superintends most of the routine work of a library. This is the rule in so very many cases that it is a good reason, if any reason were required, why only a well-trained

man should be appointed to this office. The qualifications of a sub-librarian should include a knowledge of systematic classification embracing the principal schemes ; a knowledge of the principal codes of cataloguing rules ; extensive knowledge of popular literature ; experience in the management of readers and assistants ; the principles of elementary book-keeping ; acquaintance with book-binding and printing methods ; knowledge of the leading public library rules and regulations, statutes, and the routine of committee business. It is the duty of the sub-librarian to take charge of the library in the occasional absences of the librarian, and to check and superintend all the details of the work of the assistants. In cases where committees are unable to promote from their own staff to this position, on the occasion of a vacancy, it is advisable to advertise in the *Athenæum* for a trained sub-librarian. The same rules which are laid down for the selection of a chief, should hold good in the case of a sub-librarian. No unqualified person should ever be appointed as sub-librarian, because it places an undue strain upon the librarian in training and superintending the duties of such a person, thereby throwing all the work out of gear, to the disadvantage of the public.

104. Caretakers.—A satisfactory caretaker, generally speaking, is a *rara avis*. It is difficult to find one who does not develop some radical defect—fondness for beer, laziness, Jack-in-officism, or something worse—within twelve months of his appointment. A good man rarely stays very long, so easy is it for him to seek and obtain promotion. Caretakers' wages vary all over the country, according to the size of the library, amount of work and perquisites. In cases where a residence is provided, it is usual to secure the services of a man and his wife, and furnish him with a uniform and the usual light, coal, etc. In such cases the wages are usually less than when a man has to find his own residence. From 25s. to 30s. weekly is the wage given when a house is provided. In other instances, according to circumstances, the wages vary from 27s. 6d. to 42s. weekly. In large libraries extra assistance should always be provided, and the cleaning should be done early in the morning,

before the hour of opening. A sufficient staff of cleaners should be provided to enable this to be done without interfering with the service of the public. Three hours every morning should suffice to clean any library, and it is important to employ plenty of help. The wages of cleaners vary from 6d. an hour downwards, but it is more often the practice to pay so much a week according to circumstances. Rates for this class of work differ so much that it is impossible to do more than roughly indicate a possible basis.

105. A caretaker should be made responsible to the librarian for the cleanness and order of the building, and his duties should include a certain number of hours' attendance in uniform as general overseer of the rooms and their frequenters. Nine or ten hours daily should be considered full time for this class of labour, and suitable arrangements must be made to enable the caretaker to remain off duty during the afternoons, when the business is quiet. In large libraries it is customary to employ more than one janitor or caretaker.

106. Staff and Public.—It is most important that good relations should exist between readers and the whole of the staff. It is a well-known fact that one or two overbearing assistants can render a public library more unpopular than almost anything else. Assistants should school themselves to endure with philosophy the impertinence of the small number of the general public who contrive to make themselves objectionable in every town, and not visit on the heads of the inoffensive majority the sins of the inconsiderate few. The staff of every public library should learn as a first lesson, that they are the servants and not the masters of the people; and that mutual self-respect can be maintained without undue familiarity on the one side, or aloofness on the other. The Jack-in-office attitude, which so frequently infects public servants, is to be completely repressed and kept under, and the public should be taught to appreciate their own libraries, and to understand that, however inhospitable and patronising the minions of the State may be, as shown in post-offices, tax-offices, etc., the doors of a municipal library are always open

to receive and welcome every class of citizen. At the same time, undue preference should not be shown for any particular frequenter or group of frequenters, and gossiping must be sternly suppressed.

107. Women Librarians and Assistants.—The employment of women in public libraries is not so universal in the United Kingdom as in the United States. There are perhaps 2,500 municipal librarians and assistants in the United Kingdom altogether, and of these only about 300, or 12 per cent., are women. There are 25 women who are chief librarians and 275 women assistants, and the names of the towns which employ them are set out in the *British Library Year Book*, 1900-1901, page 263. In the United States the proportion of women librarians and assistants is nearer 95 per cent. than 12 per cent. The chief reasons why women have not been more generally employed in library work in Britain are prejudice on the part of committees and librarians, and the difficulty of obtaining trained and well-educated women willing to work for the comparatively small remuneration offered. In America this latter obstacle does not exist owing to the available funds being much larger, and the fact that special technical training in the work can be obtained at the various library schools carried on in various States of the Union. In Britain there are no special means of obtaining technical training for library work, and, even if there were, the fact that salaries are so small would militate against the success of any plan of education. There can hardly be a doubt, however, that women will be more extensively employed in British municipal libraries than they have been hitherto. In large towns it is becoming increasingly difficult to obtain and retain the services of intelligent lads who will devote themselves to the work. Women being rather less ambitious than men are more likely to remain longer at the work, and in the end become more efficient. A well-educated, intelligent girl is just as suitable for public library work as a well-educated lad, and our experience is that, if less business-like in some respects, they are more reliable in others, and give greater satisfaction to the general public. If women

are employed in libraries, they should be paid at the same rate as men or lads performing similar duties. There is no reason why a woman should be paid less than a man for doing exactly the same work. The scale of pay suggested for junior and senior assistants in Section 102 should apply equally to women assistants; the juniors being regarded as girls ranging from sixteen to twenty years of age, and the seniors from twenty-one upwards. Everything we have recommended regarding qualifications, duties, etc., should apply to women as well as to men. It is strongly advised that, if women are employed, the staff should be composed entirely of them. A mixed staff is a decided inconvenience, requiring various kinds of separate accommodation, and we cannot recommend such an arrangement.

108. Library Assistants' Association.—An association with its headquarters in London has been formed to further the interests of library assistants of all kinds. It attempts, by means of meetings for the discussion of papers, study classes and branches, to improve the knowledge and status of its members. It publishes a monthly organ entitled *The Library Assistant*, and cultivates the social as well as the professional side of its work. The membership is about 200, which is only a small proportion of the library assistants in the United Kingdom, who must number close upon 3,000, counting all kinds of libraries. Assistants would greatly help their own cause by supporting this association.

109. REFERENCE LIST OF AUTHORITIES:—

STAFF MANAGEMENT.

- British Library Year Book, 1900. No. of Assistants and Hours. Pp. 261-262.
- Cowell, P. Public Library Staffs. (L. A. Series, No. 3.) 1893.
- Graesel, A. Library staff. See his "Bibliothekslehre," 1902.
- Hill, F. P. Library service [staff]. U. S. Educ. Rept., 1892-1893, v. 1, p. 74. (Has elaborate tables of salaries, etc.)
- Hill, F. P. Organisation and management of a library staff. Lib. J., 1897, p. 381.
- Hosmer, J. K. The library assistant: his title, duties, etc. Lib. J., 1899, Conf. no., p. 54.

- Hours of Service of Library Assistants. Lib. J., 1899, p. 524.
 Library hours of staff. Discussion in America. P. L., 1899, p. 849.
 Macfarlane, J. Library and its staff. *Chap. 1 of his "Library Administration"*.

STAFF TRAINING AND APPOINTMENT.

- Hasse, A. R. The training of library employes. Lib. J., 1895, pp. 202, 239, 272, 308.
 James, H. P. Special training for library work. Int. Con., 1897, p. 34.
 Library examinations and methods of appointment. Lib. J., 1901, p. 323. (American methods of making staff appointments and collection of examination papers.)
 Library schools and training classes, and special training for librarians. Symposia by American librarians. Lib. J., 1898, Conf. no., *passim*.
 Ogle, J. J. Summer school of library science. L. 4, p. 319.
 Ogle, J. J. Training of public library assistants. Greenwood's Year Bk., 1897, p. 52.
 Roberts, H. D. Education of the library assistant. L., v. 9, p. 103.
 Swann, J. H. Training of library assistants. L. W., 1899, p. 164.
 Tedder, H. R. Young librarians and self-improvement. L. A., 1898, p. 75.
 Welch, C. Training of librarians. Int. Con., 1897, p. 31.

WOMEN LIBRARIANS.

- Hewins, C. M. Library work for women. Lib. J., 1891, p. 273.
 James, M. S. R. American women as librarians. L., v. 5, p. 270.
 James, M. S. R. Women librarians. L., v. 4, p. 217.
 James, M. S. R. Women librarians and their future prospects. L. A. R., v. 2, p. 291.
 Mathews, E. R. N. Female library assistants and competitive examinations. Int. Con., 1897, p. 40.
 Smith, L. T. Openings for women in library work. L. A. R., v. 1, p. 717.
 Women as Librarians. Views and statistics. L. A., 1899, pp. 214-222.
 Women in Public Libraries. Discussion by Frank Channell and Kate E. Pierce, etc. L. W., April-July, 1902.

See also "Englishwomen's Year Book," and various works on work for women. These are mostly poor and unreliable. For number of women employed in British Municipal Libraries *see* "British Library Year Book," 1900, p. 263.

For list of abbreviations see Section 88.

DIVISION III.

BUILDINGS.

CHAPTER VII.

THEORY AND GENERAL REMARKS.

110. Theory.—Although the subject of library buildings has been very frequently treated by various writers, it is astonishing to find an almost complete lack of literature on the important question of size limitation and the modifications arising therefrom. Controversy has raged round such questions as stacks *versus* alcoves, general *versus* special reading rooms, general *versus* separate book stores, and so on, but on the much more important question, "What size is the library to be?" hardly any theories or definite statements exist. Beyond a vague general recommendation to secure as large a site as possible, in view of future extension, writers on library architecture have not committed themselves to any principle which would guide those responsible for new library buildings in estimating the provision to be made. The chief reason for this is no doubt the cherished tradition which has always existed among librarians, that libraries are to be made as large as possible, because they are the repositories of the literature of the ages and the storehouse for every kind of printed matter which can be secured by honest, or other, means. The *museum* idea of a public library has been cultivated so long, that it is difficult to advance a plea for the more practical *workshop* idea without raising a storm of opposition from those conservators of literature who imagine that their little parochial libraries rival the British Museum or Bibliothèque Nationale on a re-

duced scale. Yet, it is this practical workshop side of the question which we desire to advance in opposition to the museum, or haphazard collecting, method, which has for years prevailed.

111. There are several very important considerations to be advanced in favour of limiting libraries both as regards book storage and accommodation for readers, and these we shall proceed to set out in order. However much one may sympathise with the view that all public libraries ought to collect *everything*—on the sentimental grounds that it may one day be used, and that nothing which illustrates past customs, life, etc., should be ignored—it is only fair to point out that this work is already being most effectively done by general or special libraries in all parts of the country. This particular form of literature conservation is the chief province of the great State libraries like the British Museum, Patent Office, India Office, National Library of Ireland, etc.; the university libraries; the endowed or special libraries like the Advocates' (Edinburgh), Mitchell (Glasgow), Rylands (Manchester); the great proprietary libraries of a special kind like the Royal Colonial Institute, Athenæum Club, Signet (Edinburgh), London Library, etc.; and scientific, law and collegiate libraries of all kinds, so that the burden of carrying on this tradition of universal garnering need not in any sense be borne by municipal libraries, save as a mere sentimental concession to convention.

112. The workshop form of public library, for which we plead, has never been properly represented in Britain. As we show in Sections 252-258, 285, etc., it provides for the systematic and continuous revision of the stock of the library, and in this way it is made practicable to fix roughly a limit to the size of a building, without troubling too much about the future. This is a most important matter, because it is undoubtedly the result of a general cultivation of the museum idea which has led to the formation of huge municipal libraries, a great portion of whose contents could be discarded any day without perceptible inconvenience to any one. While we admit

the wisdom of acquiring additional land for future extension should it be required, we deny the wisdom of erecting and furnishing large buildings on the assumption that they ought to be filled as speedily as possible. The result of overbuilding is to cripple the early and most critical years of the library's existence with heavy loans and their repayment, while the upkeep of a great building ultimately designed to accommodate 100,000 volumes and 500 readers, though starting with only 10,000 volumes and 100 readers, is sure to be out of all proportion.

113. What we recommend as a compromise, is that library buildings should bear some proportion to the funds available for their maintenance, and if reference is made to the table at Section 53, Fig. 11, showing what can be provided for a certain income, an idea will be obtained of the amount which can be spent on a building of a certain size. For instance, a library with an income of £1,000 may spend £250 in annual repayments of the principal and interest of loans. For this it can borrow something over £4,000. Allowing 1s. per cubic foot as the cost of building, and 10 per cent. (or £400) for the cost of furniture, we get 72,000 cubic feet of contents, which is equal to a space 96' x 50' x 15'; or, leaving out the height of the rooms, 15 feet, is equal to an area of 4,800 square feet. On a site this size it is possible to erect a building of one storey, possessing the great advantage of having every department on one floor, which will accommodate about 34,000 volumes, 140 newspapers, magazines, etc., and about 200 readers and borrowers at one time. There are very few municipal libraries in the United Kingdom of this size which can show such results on a £1,000 income, even after twenty years' existence, and this is a strong argument in favour of the size-limitation theory which we have advanced. Applying these figures to towns possessing various incomes, we arrive at certain results which appear clearly set out in the table below. The population figures are useless as a basis, and we have accordingly adopted the income from the library rate as the most satisfactory.

114. TABLE SHOWING THE SIZE OF LIBRARY BUILDINGS WHICH CAN BE ERECTED AND MAINTAINED BY PLACES WITH DIFFERENT INCOMES.

| In- come. | Annual Repay- ment of Loan. | Build- ing Loan. | Furni- ture Loan. | Cubic Feet in Building at 1s. per foot. | Sq. Feet in Build- ing. | Vols. Stored. | Readers Accommodated. |
|--------------|--------------------------------------|------------------------|-------------------------|---|-------------------------------|------------------|--------------------------|
| £ 1,000 | £ 250 | £ 3,600 | £ 400 | 72,000 | 4,412 | 34,000 | 200 |
| 2,000 | 500 | 7,200 | 800 | 144,000 | 8,824 | 68,000 | 400 { with branches. |
| 3,000 | 750 | 10,800 | 1,200 | 216,000 | 13,236 | 102,000 | 600 " |
| 4,000 | 1,000 | 14,400 | 1,600 | 288,000 | 19,200 | 136,000 | 800 " |
| 5,000 | 1,250 | 18,000 | 2,000 | 360,000 | 24,000 | 170,000 | 1,000 " |
| 10,000 | 2,500 | 36,000 | 4,000 | 720,000 | 48,000 | 340,000 | 2,000 " |

115. Of course it is not claimed that these figures are more than theoretical approximations, as prices, conditions and ideas differ in every locality, but they do give a starting-point from which committees and librarians can work out results to suit their own circumstances. It is important that committees and librarians should start with a clear idea of what they propose to accomplish, and a careful study of the tables in this book, together with the remarks and draft plans in Chapter VIII., will enable a wise choice to be made.

116. The chief danger with most library authorities is the tendency to erect a library building out of all proportion to the funds available for its maintenance. The laudable desire for a handsome architectural exterior, which all public buildings ought to have, is frequently carried to such an extent that utility is completely sacrificed to an ornamental outside appearance. Where funds are plentiful, as they would be without a limited rate, there is no reason why a fine-looking building should not be provided, but where money is strictly limited it is necessary to consider the plans rather than the elevation. In any case, the interior arrangements should never be subordinated to the desire for mere outward show and ornament, and a library building in the hands of a competent

architect can be made of a suitable and dignified design notwithstanding the rate limitation. We have observed in very numerous cases that most of the money provided for library buildings has been spent on the structure, with the result that all the interior fittings have been cut down to the very cheapest and meanest-looking varieties. The outside of a library building is its least important feature, and should never be carried to such extravagant lengths as to imperil the utility and appearance of the interior arrangements. There are many library buildings now existing on which much money has been lavished apparently for the purpose of providing handsome façades to dazzle the townsfolk, but which, nevertheless, are not only inconveniently planned inside, but furnished and fitted up in a style which suggests a kitchen rather than a public institution. This is often brought about by a wrong division of the money borrowed for building and furnishing purposes. A sum is set apart for furniture, which would be ample if such permanent fittings as bookshelves, counters, screens, etc., were not included. But when these are provided out of a furniture loan it is seldom that a large enough sum is borrowed. It is important to remember that such fittings as bookcases, counters, screens, wall newspaper slopes, barriers, lifts, galleries, etc., form permanent parts of the building, and ought to be included in the building loan, which can be borrowed for thirty years. A furniture loan must be repaid within ten years, and only such movable items as tables, chairs, desks, office furniture, etc., should accordingly be bought from this fund.

CHAPTER VIII.

SITES AND PLANS.

117. Sites.—In choosing sites for public library buildings committees should bear in mind the following principles :—

1. They should be central and easily accessible from all parts of the district.
2. They should be as far as possible isolated from all other buildings, particularly shops.
3. Quiet side streets are preferable to noisy main thoroughfares.
4. Level sites are preferable to those on steep gradients.
5. More ground than is required for immediate use should be secured if possible.

A large number of the public libraries of the country are erected upon land which has been presented to the towns, and an endeavour should be made to procure a gift of this kind before a purchase is made. It will make a very considerable difference to the size and quality of the building which can be provided if land has to be purchased. Frequently land can be secured upon a long lease at a nominal or peppercorn rent, and when this can be done it is better than borrowing more money than the rate will allow, and thereby crippling the library in its early years. In our table in Section 53 no direct provision is made for loans for sites, but if it is absolutely necessary that money must be borrowed for the purpose, the margin which we mention as arising from incidental receipts will probably meet the annual repayments of a loan spread over fifty years, if the site and its purchase money are not excessive. But in any case, let us reiterate our advice to committees not to borrow money for sites till they have exhausted every hope of inducing some public-spirited citizen or public body to come forward

with a gift of land. This is the only way, save in towns with very large incomes, in which the inadequate provisions of the Public Libraries Acts can be in part overcome. At the same time it should be remembered that by these and other Acts of Parliament special power is given town councils and other public bodies to convey land to library authorities for building purposes.

118. **Architectural Competitions.**—When a suitable site has been secured the next step will be to institute a competition for the planning and design of the building. We have already pointed out the importance of appointing a properly qualified officer as adviser before any serious step is taken or permanent arrangement is made. We strongly repeat this advice, and urge that no plan should be drawn up or accepted without the skilled guidance of a thoroughly trained librarian. The mistakes made in the past through neglect of this necessary precaution should be a warning to committees never to trust to their own choice and judgment, and not to rely entirely upon an architect, who is generally unacquainted with the best arrangements for working a public library, however great his artistic and technical qualifications may be. Assuming, then, that a competent librarian has been appointed, the first thing to do after securing a site is to determine the size and kind of building required, and to make out a rough plan of the interior arrangements and prepare a specification of requirements or instructions to architects for the use of competitors. Unless there are local or other reasons against such a course, an open competition is preferable to a limited one. Advertisements should be inserted in the local papers, and in *The Architect*, *Builder* and *Building News*, inviting architects to compete, and asking them to apply for the conditions. Premiums should be fixed for the designs placed first, second and third in order of merit by the assessor who judges the plans. These must be regulated by the size and style of the building. £50, £30 and £20 have been offered for buildings costing £4,000 and upwards. Premiated designs become the property of the committee. The Institute of British Architects, London, should be asked to nominate an assessor at

a fee to be determined, and of course such assessor will not be a competitor. It is usual to merge the premium of the successful architect whose design is carried out into the fee paid him for superintending the work, and this amounts to 5 per cent. on the cost of the building, including all extras.

119. Instructions and Plan.—The instructions to the competitors should be accompanied by a plan of the site drawn to quarter- or eighth-inch scale, and showing building line and ancient lights, if any. They should specify the amount and kind of accommodation required on each floor, and state that the cost should not exceed a certain sum exclusive of movable furniture. Permanent fittings should include bookcases, wall and standard; screens, counters, wall slopes for newspapers, barriers, and any other kind of fixture. The conditions as regards premiums, assessing, etc., should be sent along with the instructions and site plan. All competitive designs should be drawn to the same scale (one-fourth or one-eighth inch), and should be finished in black without colour or ornament. Perspective drawings, in addition to elevations, may be sent at the discretion of each competitor. Each set of drawings should include a plan of every floor, showing proposed arrangement of bookcases, counters, furniture, etc.; an elevation of every face; and a section through the building both ways. Plenty of time should be allowed for the sending in of designs. Three months at least from date of advertisement.

120. Selection of Plan.—The competing drawings should be marked with a pseudonym, so that the assessor and committee cannot tell who the author is, and the competitor's name and address should be sent separately in a sealed envelope marked on the outside with the pseudonym selected, and the words "architect's name and address," or something to the same effect, to prevent accidental opening. It is the duty of the assessor to advise the committee as to the practicability of every design; to determine if it is in accordance with the instructions; to ascertain if it can be carried out for the amount stated; and to judge which designs are first, second and third in order of merit after fulfilling the conditions of the instructions.

121. The following rules for judging library plans will be found useful; they are based on those in Greenwood's *Public Libraries* (1891), and have been used by architectural assessors on several occasions:—

1. No public room should be made a thoroughfare leading to any other public room.
2. All exits from public rooms should be within view of the staff.
3. Oversight of public rooms should be secured without the need for special officers in every room. For this purpose ornamental glazed partitions are preferable to solid walls.
4. No passage for public traffic should be less than 4 feet wide. Where movable chairs are used in passages, these should be from 5 to 6 feet wide.
5. Cross gangways between table and bookcase-ends should not be less than 3 feet if used as thoroughfares, but may be 2 feet only if simply spaces to enable readers or assistants to pass round.
6. Bookcases should not exceed 7 feet 6 inches in height either in open access or closed libraries, and shelves should be of the uniform length of 3 feet.
7. Standard bookcases in open access libraries should be spaced at not less than 4 feet apart when facing each other, and in closed libraries at not less than 3 feet apart.
8. Magazine room readers should be allowed about 8 superficial feet, including table and passage room.
9. Reference library readers should be allowed 12 superficial feet, including table and passage room.
10. Where indicators are used in lending libraries the counter space should provide 5 feet run for every 4,000 volumes stored, or 15 inches per 1,000 numbers, and at least 10 feet run of clear space for service. The public space in front of any such counter should not be less than 10 feet wide, unless in a very small library, when it may be 6.
11. In open access lending libraries the spaces should not be less than those shown in Fig. 16 in Section 125.
12. Allow ten volumes per foot run in lending library shelving, and nine volumes per foot run in reference library shelving. A 7 foot 6 inch bookcase should give an average of eight shelves per tier in a lending library, and about the same in a reference library, if separate provision is made in wall cases for folio and other large books.
13. Public lobbies and staircases must be arranged according to the rules laid down by any local or general building act or bye-law.
14. Newspaper slopes should allow an average of 4 feet run for every paper. This will provide for spaces between papers.

In some towns the competition designs for library buildings have been placed on exhibition, to enable the public and other interested persons to compare the premiated with the other drawings. This seems an admirable procedure, regarded as a mere matter of policy, but the practical advantage is somewhat doubtful.

122. Library Planning.—In Chapter X. we have set out in detail some of the chief requirements of the different departments of a public library, and here we shall state a few general principles and illustrate them with draft plans, before proceeding to the other points connected with new library buildings. It is impossible to fix any data which will apply to all sizes and shapes of sites, on account of differences introduced by difficulties of lighting, approaches and varying local requirements. The data given above (Section 121) can be applied in most cases, as dimensions of this class seldom vary, but any additional data are certain to be modified by local conditions.

123. The chief principle which we wish to lay down here is the one already stated in Sections 110-113, and further considered at Section 252, namely, that public libraries should be constructed and stocked with the view to constant revision, and that their size should be limited by the number of *live* books likely to be wanted at any period. What the number of actually living books will be at any given period, it is difficult to say, but judging by the selections which have been made in histories of literature and in such books as Sonnenschein's *Best Books*, it may be roughly estimated that there are not more than 50,000 works of perennial interest which are worth storing in a modern workshop library. Even this huge number could be reduced by one-half, and still be made thoroughly representative of every literature, every period and every subject of human interest. It may be stated as a fact, that not a single British public library possesses the number of volumes which it might have, according to our table of income and loans at Sections 53, 114, 254. A brief comparison of the information and tables given in Greenwood's

British Library Year Book, 1900, will prove this at once. In the largest municipal libraries a very considerable proportion of the stock is composed of duplicates of popular books in central and branch libraries, while practically one-half of the stock of such libraries consists of *dead* literature which is never inquired for. The provision of book-storage should, therefore, be limited in the case of municipal libraries, not so much by the size of building which can be afforded by the income, but by the actual living books which are likely to be required.

124. The figures given in the table in Section 114 may be very considerably modified, both as regards stock and accommodation for readers, because not one of the totals will ever be reached unless there is a removal of the rate limitation, or a very rapid growth of the town, amounting to a doubling of the population in ten or twenty years. In libraries which start with incomes of £500, provision should not be made for more than 20,000 volumes. In those with commencing incomes of £1,000 to £2,000, room for 40,000 volumes will be found ample. From £2,000 to £3,000, 60,000 volumes; from £3,000 to £4,000, 100,000 volumes; from £4,000 to £5,000, 130,000 volumes; from £5,000 to £6,000, 160,000 volumes, and so on. Bearing these figures in mind, the planning of library buildings becomes greatly simplified. The main points to be aimed at in library planning are good light, convenient access to rooms, a fair amount of oversight, and the arrangement of departments so as to secure quietness in the principal reading rooms. For this last reason, the reference library should always be put farthest away from both newsroom and lending library, so that the traffic of these departments will not disturb readers. In small libraries it is best and most convenient to keep the whole of the departments on one floor, obtaining light, if necessary, from the roof.

125. The draft plans which are given in this section illustrate most of the principal points which we have raised. They will also serve as suggestions to committees, librarians and architects charged with the establishment of new library buildings. Fig. 16 represents a building which can be erected by a library

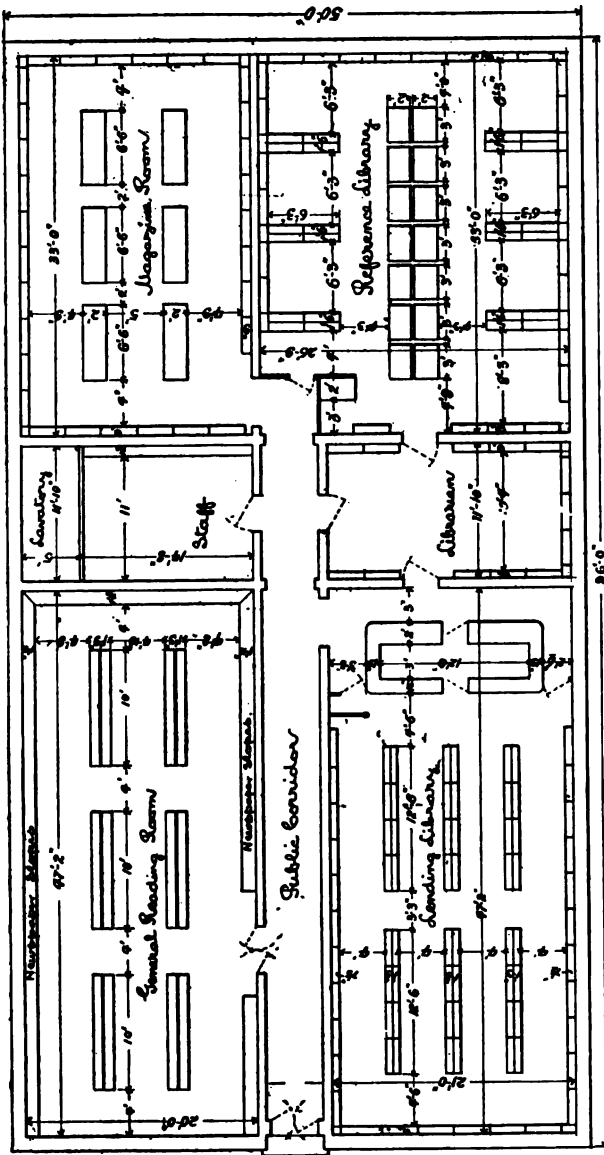

FIG. 16.—Sketch Plan of a Library on one floor (Section 125).

authority having an income of £1,000, from which a loan of £4,000 can be afforded, as per the table in Section 114. It is all arranged to go on one floor, thus doing away with stairs, and rendering access easy. The news- and magazine-rooms will remain as they are arranged whatever alternative plan may be adopted for the other departments. There are locked bookcases all round the walls of the magazine-room for storing

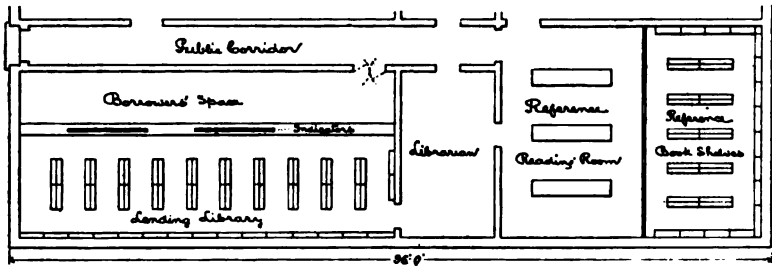

FIG. 17.—Lending Library arranged with Indicator for all the Books. Reference Library with Barrier (Section 125).

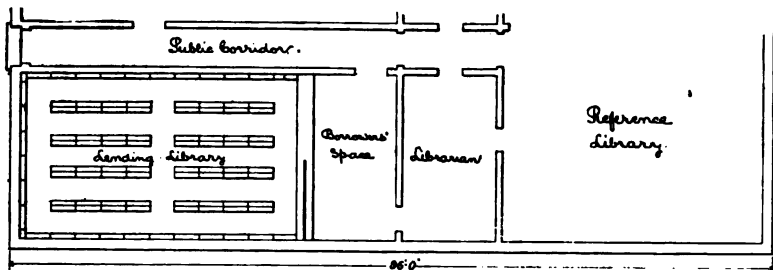

FIG. 18.—Lending Library arranged with Indicator for Fiction only (Section 125).

books. The lending library is arranged for the open-access system, but two alternative plans are also given, one (Fig. 17) being a lending department with an indicator for all classes of literature, and the other (Fig. 18) being arranged for an indicator to fiction only. The reference library is also arranged for open access, with an alternative plan (Fig. 17) for a barrier cutting readers off from the book-shelves. The remaining plans (Figs. 19-20) show how a building double the

size of Fig. 16 can be conveniently and economically arranged on two floors. In Chapter X. every department of the library is separately considered, both as regards its needs and planning, and it is needless to go over the same ground again.

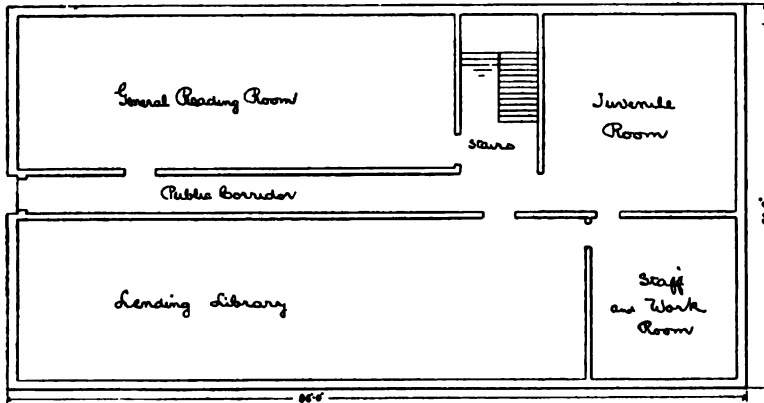

FIG. 19.—Ground-floor Plan of a two-floor Library (Section 125).

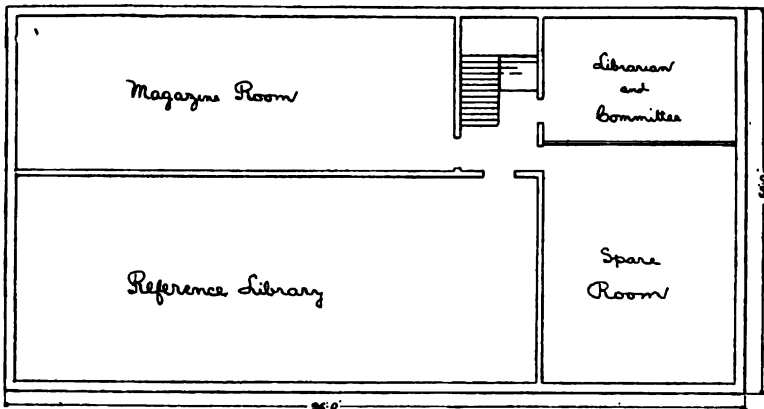

FIG. 20.—First-floor Plan of a two-floor Library (Section 125).

126. Building Specification and Contracts.—The specification for the building on which builders are required to tender will be prepared by the architect, and it is usual in most cases

to have the quantities abstracted by a surveyor, so that contractors can all tender for the same thing. The surveyor's fee is usually included in the specification, as are also allowances for other extras, such as foundation-stones, memorial tablets, and such items as presentation trowels, etc., if a foundation-stone laying is made a public ceremony.

127. The contract for the building should be publicly advertised in such journals as the *Contract Journal*, *Builder*, *Building News* and the local newspapers, and the tenders should, when received, be opened at a meeting of the library authority to which the firms who tender should be invited. When a contract is accepted and signed it should contain a clause specifying that all extras must be sanctioned by the library authority before being put in hand, and must be certified by the architect when completed. It is well to avoid extras by making a careful estimate in advance, but if they are supplied, great precaution must be used to see that they are limited and strictly watched.

128. A clerk of works must be appointed to watch over the building operations on behalf of the library authority and the architect, and it is a wise and most economical policy to pay for a first-rate man. The wages of a competent man, who is usually recommended by the architect, will amount to from £3 to £4 weekly, according to circumstances.

The architect's fee is 5 per cent. on the total cost of the building, including extras and all furniture or other fittings which he may design.

129. **Opening Ceremony, etc.**—There are certain ceremonial matters connected with the laying of foundation-stones, unveiling of memorial stones or brasses and opening ceremonies, which each locality must arrange to suit its own needs. An opening ceremony of a public character is always so useful in making known a library, that it ought when possible to be arranged. It need not be a very expensive function, and if an eminent public personage, local or otherwise, can be secured to perform the ceremony, so much the better. It is a doubtful point whether the expense of an opening ceremony can be

defrayed from the library rate. In districts where the expenditure is audited by a Government auditor, a moderate sum is generally passed, with the caution not to incur such charge again. It may, therefore, be taken for granted that any reasonable sum expended on a suitable public opening ceremony, will be regarded in a benevolent light by the central financial authorities. But such expenditure, we assume, would not include any extravagant item such as banquets, receptions, etc.

130. REFERENCE LIST OF AUTHORITIES :—

- Adams, H. B. Public Libraries and popular education (Home Education Bulletin, No. 31). Albany, University of the State of New York, 1900. (Valuable for the elevations and plans of American library buildings beautifully reproduced.)
- Brydon, J. M. Public Library architecture. L. A. R., v. 1, p. 258.
- Burgoyne, F. J. Library construction: Architecture, fittings and furniture, 1897.
- Points in library planning. Greenwood's Year Book, 1900, p. 12.
- Graesel, A. Library architecture. See his "Bibliothekslehre," 1902.
- Green, R. R. Planning and construction of library buildings. Lib. J., 1900, p. 677.
- Pite, B. Architecture for libraries (art view). L., N. S., v. 1, p. 326.
- Public library architecture. Int. Con., 1897, p. 106.
- Utley, H. M. How to plan a library building. Lib. J., 1899, Conf. no., p. 21.

For list of abbreviations see Section 88.

CHAPTER IX.

HEATING, LIGHTING, VENTILATION, CLEANING.

131. **Heating.**—The architect is generally able to advise as to the best system of heating, but there are several points which may be mentioned, as they are sometimes overlooked. On no account allow open fire-places to be installed. Apart from the danger from fire which their use entails, they cause endless trouble by requiring constant attention, and are the source of much dust and uncleanness. Moreover, they attract loungers, who hover round them at all times, to the destruction of their utility as fires, and because of this they occasion considerable disorder among readers. This caution is not inserted as a joke, but as a serious warning to library authorities not to permit architects, with ideas more picturesque than practical, to increase the difficulties of administration by sacrificing utility to artistic effect. If open fire-places are installed anywhere, in such situations as committee rooms, staff or librarian's rooms, or in similar comparatively small rooms, they should be utilised as gas rather than as coal fires.

132. Hot-water pipes, with heat radiators distributed in the most effective situations, are now almost universally used in public buildings. The furnace in connection with the heating system should be placed in a chamber outside the building if possible, or, if not, in some out-of-the-way part of a basement in a fire-proof room. This may make a very considerable difference on the insurance premium. Distributing pipes should in every case, when possible, be placed under the floors. The heat radiators should be arranged so as not to come into close contact with woodwork, and they should be kept out of any public thoroughfares or gangways where they are likely to be

Sec. 133 HEATING, LIGHTING, VENTILATION, CLEANING.

in the way. Nothing looks worse than a huge coil of hot-water pipes stuck up in some prominent part of a public building. All taps which are attached to radiators or pipes should be made to screw or turn by means of a key only. They are thus safeguarded against mischievous youngsters and others, and are thoroughly under the control of the authorities.

The heating apparatus should be included as part of the building specification. We mention this because in one public library this provision was overlooked, and when the omission was discovered, all the available building money had been expended!

133, Lighting.—A public library building, and especially its reading rooms, cannot have too much daylight. To secure this, all windows should be made as wide as possible, and should extend the whole height of the room, from about four feet above the floor to a few inches from the ceiling. Coloured and rippled glass should be avoided, unless in exceptional situations. Narrow windows in the Gothic style, which imitate old collegiate and church buildings, are to be shunned. Light in libraries is much more desirable than decoration or sentimental imitations of the antique. The fixed iron window frames which are frequently provided for public library buildings are an abomination, and should be forbidden. They hinder effective ventilation, and, when they become dirty, it is necessary to requisition the fire-brigade in order to have them cleaned! It is better to spend a little more in the first instance to obtain windows which can be opened for cleaning and ventilating purposes, than to be hampered by fixed windows which will be a continual expense and inconvenience in the future. In some portions of a library building it frequently happens that from structural or other causes there are dark lobbies or nooks, or even rooms, which are not effectively lighted by ordinary windows. In such cases the prismatic or Luxor window lights are often efficient. White tiled walls also give a very fair reflected light in similar positions. It is perhaps hardly necessary to add that, where windows are directly exposed to the sun, blinds should be provided.

134. Artificial lighting should be carefully considered, both by the library authority and the architect. Where it is possible the electric light should be installed. In other cases gas must be employed. Save in very large buildings it is not advisable to install an electric-light-producing plant. If a public supply is not obtainable, we think gas is preferable to home-made electric light. But authorities differ somewhat on this point. The cost of electric as compared with gas lighting differs greatly in every locality, owing to variations in the charge per Board of Trade unit, and the methods in vogue of making up accounts. Generally speaking, every sixteen candle-power lamp will cost about 20s. per annum, and it is safe to estimate this annual charge as about one-half as much again as gas. But of course there are advantages. The electric light is not only better, cleaner and healthier than gas light, but is more easily adjusted to suit special conditions, and much more convenient and safe to use. With the electric light the need for internal cleaning is greatly lessened, and, under ordinary circumstances, a new building or freshly decorated one will not require cleaning in ten years' time. With gas light, on the contrary, some kind of internal cleaning must be undertaken every two or three years. Frequent cleaning is a serious item in the expenditure of a library, as it must come off the book-fund in most cases, and hence the efficiency of the institution for that year is greatly reduced.

135. Electric light installations in public libraries need not be very elaborate. Heavy ornamental pendants and brackets are quite unnecessary, and simple hanging lamps will be found most effective and economical. In some large reading rooms with lofty ceilings arc lamps have been introduced with considerable success. There is some difference of opinion as to the comparative merits of a good, general, well-diffused light and separate, independent lighting for each table, stand and book-case. If the light can be got to imitate daylight as much as possible, and is well diffused, the general effect is superior to independent lighting, as the rooms are all illuminated, and a good deal of aid is got from reflection from ceilings and walls.

Sec. 136] HEATING, LIGHTING, VENTILATION, CLEANING.

Standard lamps on or immediately over each table or stand, throwing a concentrated light on the one spot, have the advantage of giving a brighter and stronger light, and they may also be switched off when not in use. But the general effect in a large reference library only half tenanted is desolate and patchy in the extreme. An intense light concentrated upon one particular spot, like the arrangement in use in billiard rooms, is not, in our opinion, so restful and really effective as the result obtained in the studios of art schools, by throwing the light on to a brightly white ceiling, from whence is reflected a most beautiful, soft and thoroughly diffused light. Of course, this arrangement is not suitable for a public library reading room, and a compromise will probably be the most satisfactory in the end. In all public rooms a good general light should be provided, which may be reinforced where necessary by means of separate standard or other lamps which can be switched on or off as required. It should be remembered that standard lamps on reading tables are very apt to cause an uncomfortable glare in the eyes, unless very carefully adjusted. There is another very strong objection to standard lamps, and that is the great expense entailed if the furniture to which they are attached should at any time have to be rearranged. This may be a very serious matter in some cases, and is an argument against fixity. The cost of installing the electric light, including wiring, plain lamps, switch-board and everything complete, works out at from 18s. to 25s. per lamp, according to the style of fittings adopted. Heavy brass and ornamental pendants will run the total cost up very considerably. It is better and more economical in the end to have every lamp controlled by a separate switch. For the lighting of public rooms lamps may be grouped in twos and threes for switching purposes, according to circumstances, as the most of a general reading room has to be lit up at one time, but in most other situations separate switches should be the rule.

136. Gas lighting is so well known and understood that a very few remarks will suffice for the subject. With gas, diffused lighting is more necessary than in the case of electricity.

It is not easy to have standard gas lamps brought to tables without great trouble and expense, and of course a re-arrangement of furniture would mean complete reconstruction. Plain burners or gas jets should only be used in store rooms and other similar situations. They should be protected by means of wire cages or globes. In public rooms the Welsbach system of incandescent lighting can be made very effective, and, as a bright white light is preferable to a dull yellow one for reading purposes, it is perhaps best to contemplate an installation of this description. Otherwise, the regenerative burners, like the Meteor or Wenham lamps, should be used rather than groups of sunlight burners, which are apt to flicker and give off both heat and smoke. Wherever large gas lamps are installed, care should be taken to have them well ventilated, so that the smoke and fumes will not only pass into the open air, but will act as an aid to the general ventilation of the rooms. This is usually arranged by causing the lamps to connect with ducts or shafts in the ceilings which carry all the products of combustion outside the building. The cost and trouble of maintaining incandescent gas lamps should be considered as items of considerable moment when an installation is contemplated. The mantles are a constant source of trouble, and in most cases it is the best plan to make a contract with a gas-fitter or the manufacturers for maintenance. All the varieties of gas fittings are known to architects, and it is only necessary to advise that brackets within public reach should have taps which can only be operated by means of a key.

137. Ventilation.—When a discussion takes place at any meeting of librarians on library buildings, ventilation is the one point which every speaker feels thoroughly competent to discuss. It is the one topic on which every architect and engineer feels confident in being dogmatic, and apparently it is the one solved problem in architecture. Yet it is only necessary to enter a crowded church, theatre, public library, or even a roomful of people in a private house, to have it very strongly forced upon your senses that there is still something to be done to secure effective ventilation. In public libraries this

Sec. 137] HEATING, LIGHTING, VENTILATION, CLEANING.

is particularly the case, and it does not seem to matter what precautions are taken, every public reading room, from the British Museum downwards, is cursed with the same stuffiness or extremes of heat and cold. It matters little whether a library has a special gas engine at work, carefully selecting and sucking out the bad air, or a steam engine blowing in fresh air through moist cloths, the effect is the same everywhere—mustiness and odours. Mr. George Gissing, the novelist, once wrote a short story to show that the atmosphere of a public library, charged with bad smells and the breath of wastrels, disappointed geniuses, weary brain workers, loafers, etc., had the effect of acting as a drug upon a certain type of reader; dragging him, as by a spell, even from his work, to sit and stew, and read, in the fetid air of a public reading room. The balmy atmosphere of a busy reading room, say on a wet, close day, may have this attraction for some people, but most others have a very different opinion of its attractiveness. The chief reason for the closeness and heaviness of the average reading room atmosphere is the general tendency to overcrowding, caused by inadequate provision of space. Newsrooms are the most objectionable of all the departments, because they attract a dirtier type of reader, and because the provision of standing-room only at newspapers causes more people to congregate on a given superficial area than is right or proper. The use of double-sided standard newspaper slopes distributed all over a room tends to increase the evil, and it is better to spread newspapers round the walls and near windows for the purpose of maintaining a fair measure of freshness in the air. The newsroom should have every aid to ventilation it is possible to supply, such as electric fans, Tobin's tubes for admitting fresh air, and, above all, plenty of opening windows either in the walls or the roof. All rooms where readers sit for hours should be as well ventilated as the present defects of ventilating science will admit, but chief reliance should be placed upon opening windows for changing the air. There is a certain amount of simple and direct effectiveness about plenty of open windows which does not seem to be obtained by the various

mechanical or automatic methods which are so widely advertised.

138. Decoration and Cleaning.—It is usual to leave the final decoration of new buildings for a year or so till they are thoroughly seasoned, meanwhile finishing them off with distemper, or some such medium. The result of this in some cases is that libraries never get properly decorated at all. Where it is possible, we strongly recommend that all public rooms or passages should have their walls lined up to a height of six or seven feet with a dado of light decorative tiles. For cleanliness and even effect nothing can surpass them, and, if they are more expensive in the beginning, they will be found much more economical in the end. The wall spaces above such tiles should be finished in oil paint, which is less liable than distemper to become dusty and dirty. The rooms which have bookcases round the walls will not require this lining with tiles, nor will screens or partitions composed of nicely finished woodwork, but in other situations, particularly lobbies and wall spaces not occupied by fittings of a permanent kind, tiles should be used. Where the electric light is used, ceilings can also be decoratively finished off in oil paints; but where gas is used, it may be wiser to use coloured distempers, as being cheapest to renew. In most situations, paint is preferable to distemper, because it can be washed and kept clean for a longer time.

For cleaning purposes a supply of water should be provided on every floor, with sinks if at all possible.

139. REFERENCE LIST OF AUTHORITIES:—

- Burgoyne, F. J. Lighting, heating and ventilation. *See his "Library Architecture,"* pp. 26-38.
- Discussion on Lighting, Heating and Ventilation. *Lib. J.*, 1893, Conf. no., p. 28.
- Greenhough, W. H. Ventilation, heating and lighting of public libraries. *L.*, v. 2, pp. 381, 421.
- Hart, J. W. Heating, lighting and ventilating public libraries. *Greenwood's Year Book*, 1897, p. 38.
- Patton, N. S. Heating, ventilation and lighting of libraries. *U. S. Educ. Rept.*, 1892-1893, v. 1, p. 718.

For list of abbreviations see Section 88.

CHAPTER X.

DETAILS OF ACCOMMODATION.

140. We have already alluded to the theories as to arrangement of books, readers, etc., in Section 110, and will now proceed to consider more closely some of the important details which ought to be carefully considered both by library committees and architects.

141. **Reference Library.**—The chief defect in the planning of the reference department is generally a failure to differentiate between the needs of the student and the mere magazine reader. The same amount of accommodation which is allowed to the magazine reader—a seat at a long table with about twenty-four or eighteen inches of sitting space, and half of a two or three foot table in front—is, unfortunately, considered quite sufficient for the reference reader and student, with his note books, various works of reference and other apparatus. It seems to be entirely overlooked in some libraries that the reference reader requires not only isolation to a very considerable extent, like that provided in the British Museum, but plenty of space in which to spread out the books and papers which are his tools. No student or reader who makes extracts, or who has to wrestle with obstinate facts in history, science, art or philology, can do so if he is environed by other persons similarly or otherwise engaged, at very close quarters. Nothing is more disconcerting and uncomfortable to a working student or earnest reader than the unpleasant nearness of other people. We attribute a large share of the unpopularity of reference libraries in general, but British ones in particular, to the crowding and discomforts which have to be faced, owing to the general failure to realise the paramount importance of the reference

department, and to make it attractive as well as roomy and comfortable. For these reasons, we advocate the provision of small, self-contained and separate tables for reference readers, similar to those described in Section 220, which not only give plenty of space on the top, but also provide a definite amount of storage space for books, etc., under the tables themselves. The use of long general tables should be discontinued, and greater efforts made all round to improve the furniture and surroundings of the reference department, so as to make it a more serious and formidable rival of the lending department.

142. In planning the reference department care should be taken to place it in the quietest and lightest part of the building, away from the noise of streets and the traffic of newroom and lending library readers. Provision should be made for an open shelf section, which ought to form an indispensable department of every modern public library. On the library plan given in illustration No. 16, the reference department is intended for complete open access, save as regards any wall shelving devoted to rare and valuable books not suitable for indiscriminate handling by the general public. Other less used reference works will be stored in the locked wall-shelves provided in the magazine room shown on the same plan. But whether entire or only partial open access is contemplated in the reference library, a liberal provision of books on open shelves should form part of the equipment of an up-to-date library.

143. Magazine Room.—The wall space of this room, as shown in illustration No. 16, can be very conveniently occupied by a series of bookcases with locking doors, fitted with wire grills instead of panels. In these cases can be shelved the older and more valuable books not suitable for open access, or which are seldom asked for. Part of the space can also be reserved for withdrawn or discarded books and for other storage purposes. The magazines may be kept either on the tables or in a special rack, as may be deemed best, but as this is further discussed in Chapter XXXII., it is not necessary to dwell further upon the subject now.

144. Newsroom.—Newspapers are best displayed upon

Sec. 145] DETAILS OF ACCOMMODATION.

wall stands where possible, as more oversight can be obtained, and the economy over standard slopes, with papers on both sides, is undeniable. A newsroom fitted with newspaper stands at right angles to the walls, and covering most of the floor space, presents a very crowded and obstructed appearance, and it is impossible for the staff to thoroughly overlook it without considerable trouble. Apart from this a newsroom gains much in appearance, spaciousness and airiness by having the news-



FIG. 21.—Newsroom with Wall Slopes. Fulham Public Library (Section 144).

papers relegated to the walls, well out of the way (Fig. 21). The weekly journals can be kept very conveniently on tables provided with rails, as shown in Sections 221-223, and it is sometimes found advantageous to secure them by means of cords or chains as described in Section 483.

145. Lending Department.—In Section 125 of Chapter VIII. plans are given for libraries arranged for open access or indicators, and it may be added that the alternative plans, Nos. 17 and 18, can be used without indicators, but with card or

ledger charging instead of open access. But architects and librarians should be prepared to plan rooms for any kind of system, and should study every arrangement likely to be adopted or used. As safeguarded open access is unquestionably the system which will in future be most in vogue, both in Britain and America, it ought to receive much more attention than it has hitherto done. It is important to note that indicators are quite unnecessary in small libraries issuing less than 300 volumes per day, and no provision should be made for them unless by special request. It is also advisable for an architect to ascertain what kind of indicator is going to be used, if one is contemplated, and whether it is proposed to use it for all the books, or only for fiction. These points should be carefully considered, as some of them may very materially affect the plan of a library. (See Sections 158-159 and Chapter XIII.)

146. **Staff Rooms.**—In small libraries the librarian's room can be used as a meeting place for the library committee. It is advisable in large libraries to provide a suitable room for the library committee, even if it is in the habit of meeting in the committee rooms of the local authority. The accommodation provided for the librarian and staff on plan Fig. 16 will be found ample in libraries of moderate size, but it is advisable to give more space and additional room for caretaker's utensils and stores in larger places. Separate lavatory accommodation should also be arranged for in large libraries, and it is important to remember that in libraries with a staff composed partly of men and partly of women, this is absolutely indispensable. Separate mess rooms should also be provided for male and female assistants, as well as separate cloak rooms.

147. **Public Lavatory Accommodation.**—This should not be provided by public library authorities at all, unless to a very limited extent for the use of reference library readers. It is the duty of the sanitary or public health authorities to provide this kind of public accommodation, and not library boards with painfully limited funds. Somewhere adjacent to the library building provision of this kind can be made by the local authority, and

it will be found a convenience to the public and a relief to the library funds.

148. Librarian's and Caretaker's Residences.—In small libraries it is not advisable to incur additional cost in the erection of buildings by providing a residence for the librarian. In London the practice has been more prevalent than elsewhere, and the original idea seems to have been that, if a house was provided, a smaller salary could be paid. This has not proved to be the case in most instances, and beyond the advantage of having a librarian living on the premises as a kind of superior perpetual caretaker, there is little to be gained by complicating a library building with such an excrescence as a residence. If houses are provided at all, they should be mainly used by caretakers who have to get up early, and there is a decided convenience in having an officer of this description on the spot and always at hand. If possible, residences of this sort should be erected as far away from public reading rooms as they can be; the occupation of rooms over newsrooms, etc., having been proved to be very unhealthy in many cases. The accommodation provided for a caretaker usually consists of a sitting-room or large kitchen, parlour, two bedrooms, and the usual offices. In some London libraries very liberal provision has been made for librarians living on the premises, the accommodation consisting of three large public rooms, four or five bedrooms, kitchen, scullery, bathroom and other offices. The whole question of residence or non-residence is one for library authorities to decide for themselves, but the matter is another proof of the necessity which exists for appointing librarians before buildings are erected. It should be remembered that a librarian's house on fairly liberal lines may cost anything between £600 and £1,000 extra, representing a considerable annual charge for repayments of loans. Other aspects of this matter are discussed in Section 81, and it only remains to state that, from the health point of view, residence over the public rooms of libraries has not been found entirely satisfactory.

149. Work and Store Rooms.—In libraries which employ large staffs it is advisable to have special rooms for such work

as preparing books for issue, cataloguing, repairing, storage, etc. It is not always practicable to take work to the particular department where an assistant may be engaged, and for that reason a general workroom, provided with plenty of tables, benches and shelving, together with gas stoves, light and cupboards, should be arranged for, in addition to any separate staff or other accommodation. Binding and repairing rooms, caretaker's store room, etc., are also provided in most of the larger libraries.

A strong room of fair dimensions should be formed in the safest part of every large public library. It should be shelved to contain such documents as registers, minutes and other local records in a convenient manner, and should be kept well ventilated and dry for the safe preservation of its contents. Strong rooms vary in size from 4 feet \times 6 feet \times 8 feet, to large apartments 20 feet \times 20 feet and upwards.

150. Special Accommodation.—In our opinion, accommodation for museums, art galleries, classes, club and recreation rooms should not be provided in connection with public libraries, unless their cost is borne by special funds. The library rate should not be used to provide accommodation for other departments, when it is insufficient in most cases to support a library.

151. JUVENILE ROOMS.—If it is advisable to provide separate juvenile reading rooms and libraries at all they should be housed in buildings by themselves, in preference to crowding and complicating the general library. There are strong and reasonable doubts as to the wisdom of treating juveniles like a separate class of human beings, and making all kinds of arrangements for their convenience, very often to the inconvenience of adults. Within certain limits we believe in the policy of giving juveniles under twelve years of age rooms for their own exclusive use, but it is more on account of the trouble and annoyance which they cause to serious readers and students, than because we recognise any sentimental title to exceptional treatment which such children deserve. Most intelligent lads and lasses of twelve years of age can use ordinary reading rooms and libraries with

as much circumspection and profit as their elders. It is not a very strong tribute to their capability to propose to treat them like a lot of helpless imbeciles, as is done in certain American libraries, where the craze for grandmotherly library management in the exclusive interests of children is carried to a ridiculous extreme, very often to the prejudice of the more important general work of the libraries. In many cases the juvenile and school library craze is simply a means of diverting attention from other departments of the library which will not bear close scrutiny. However much the needs of young children require attention at the hands of library authorities, it will be soon enough to make all necessary provision of this kind from the funds which remain after the more important departments are established. Every intelligent boy and girl who can read is, or ought to be, entitled to use the public library, and, so far as lending libraries and general reading rooms are concerned, there seems to be no serious difficulty. It is when separate reading rooms are proposed in buildings of very limited extent that real difficulty will be experienced. In large library buildings where there is room it will be wise to provide a large reading room and lending library combined, for the use of youngsters, in cases where no age limit has been fixed, or where it is fixed at eight years of age. This room can be confined to children from eight to twelve years of age. The fittings of such rooms need not be luxurious, and it is well to decorate the interior walls with historical cartoons and maps.

152. WOMEN'S ROOMS.—About eighty public libraries in Britain have provided separate rooms for the use of women, but it is doubtful if such accommodation is really necessary. If there is plenty of room in the building there is no harm in making this extra provision, provided the room can be properly overlooked, but in cases where space is limited, it is a mistake to cramp the rest of the building for the sake of a somewhat sentimental idea. A few extra women of a fidgety or timid sort may be attracted to the library because of this exclusive accommodation, but the great majority of women prefer to use the ordinary departments of a public library on the same foot-

ing and conditions as men. If women can use the crowded spaces in front of restricted lending libraries, and can mix with men in open lending libraries, they can surely use the reference rooms without harm or inconvenience.

153. **STUDENTS' ROOMS.**—This is another class of extra accommodation which is unnecessary if the reference department has been properly arranged and organised. It only establishes another privileged class, and makes further demands upon the staff for service and oversight. A reference library on the plan laid down in illustration No. 16 and Section 141 will meet every possible requirement of students of all kinds.

154. **LECTURE ROOMS.**—Where space is not limited and funds permit it is a good thing to provide a large spare room which can be used for occasional lectures, exhibitions or similar purposes, without disturbing or upsetting other departments of the library. It is not necessary to provide a lecture theatre with rising tiers of seats, because the kind of demonstration for which this class of accommodation is provided will seldom or never be employed in connection with public library lectures.

155. In connection with certain libraries the question has been raised of providing refreshment departments similar to those established in colleges, schools, mechanics' institutes, polytechnics, etc. Of course there is no power for public municipal libraries to do anything of this kind, and if it were undertaken it would require to be the private venture of the committee or one of the officers. The question of its desirability is quite another matter. Personally, we doubt if the necessary separate accommodation could be provided out of the library rate, and certainly no apparatus or fittings could be purchased from such funds. If a spare room exists in a public library building, no doubt a committee could arrange with a caterer to supply light refreshments, and their action would probably never be challenged, but we doubt the wisdom of introducing such a department into public municipal libraries.

156. It should be remembered that every extra room or department proposed, especially in the case of the smaller

Sec. 156] DETAILS OF ACCOMMODATION.

libraries, means an additional drain upon limited funds; the possible cramping of more important departments; the provision of extra staff for service and oversight; and generally a considerable additional burden on the time and energy of committees and staffs.

DIVISION IV.

FITTINGS AND FURNITURE.

CHAPTER XI.

MISCELLANEOUS FIXTURES AND FITTINGS.

157. It is important to note, as we have pointed out before, that all fittings which are fixtures, like most of those about to be described in the following chapter, should be regarded as part of the permanent structure, and not as movable furniture. Such fittings should be included in the loan raised for building, which can be borrowed for thirty years, and not in that raised for furniture, which can only be borrowed for ten years. The additional twenty years for which money can be borrowed for permanent buildings will be found to make a very considerable difference in the annual repayments.

158. **Counters and Barriers.**—Counters and barriers are required chiefly in lending and reference libraries, or in situations where it is necessary to cut readers off from books or private rooms. No lending library counter which has to carry an indicator should be more than thirty inches high and eighteen inches wide, and for ledger or card charging and open access the dimensions need not be more than thirty-two inches high and two feet wide. Reference library counters for cutting readers off from the books and for service should be thirty-two inches high and two feet wide. All counters should be fitted on the staff side with shelves and cupboards, and on the public side the panelling should be raised at least four inches from the floor to prevent it from being kicked and marked. It is a useful plan to fit up the back of a long counter with shelves,

Sec. 159] MISCELLANEOUS FIXTURES AND FITTINGS.

drawers and cupboards alternately, as shown in the following diagram :—

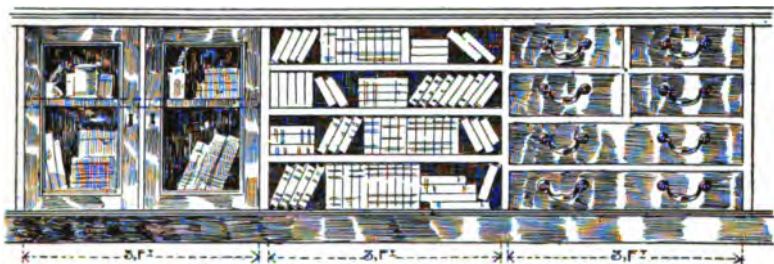

FIG. 22.—Back of Library Counter (Section 158).

This arrangement can be carried out to any extent and in any order, according to space. In lending library counters a slot for money should be made in the top of the counter over one of the small locked drawers. This will form the till for cash receipts from fines, catalogues, sales, etc.

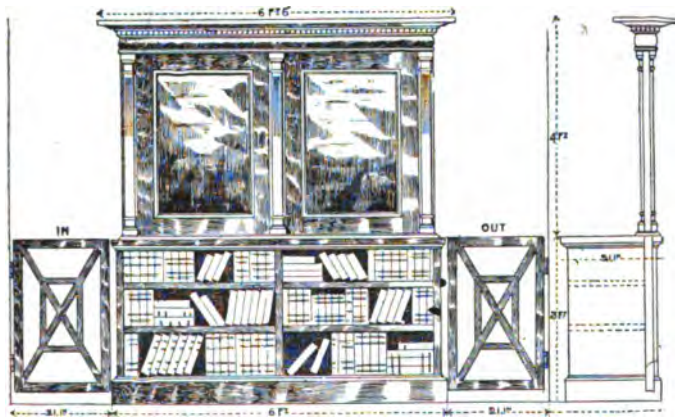

FIG. 23.—Elevation and Section of Barrier for an Open-Access Reference Library (Section 159).

159. Barriers for open-access lending and reference libraries are made in various forms. In small open-access libraries the

barriers need only be large enough to control the entrances and exits of readers. The illustration (No. 23) shows a simple barrier for a reference library which provides space for an assistant, who can control the wickets by means of the treadle latches used at Croydon, Hornsey and elsewhere. It is advisable to cause readers to return the books they have been using to the assistant at the barrier, who can keep a note of the number of books consulted, and also check readers going out



FIG. 24.—Open-Access Library Counter at Fulham (Branch) Library (Section 160).

and in. Where there is only a small space in a reference library, a three-foot glazed screen and the barriers can be substituted for the size shown above.

160. Lending library barriers for open access are practically the same as the reference kind, save that they are generally larger and have plenty of room for charging trays, etc. The following is a typical illustration of a barrier or combined counter and screen specially designed for an open-access library (Fig. 24). The object of the glazed screen is to protect the staff from

Sec. 160] MISCELLANEOUS FIXTURES AND FITTINGS.

draughts and the charging system from being tampered with. The following plans of open-access barriers show the usual ar-

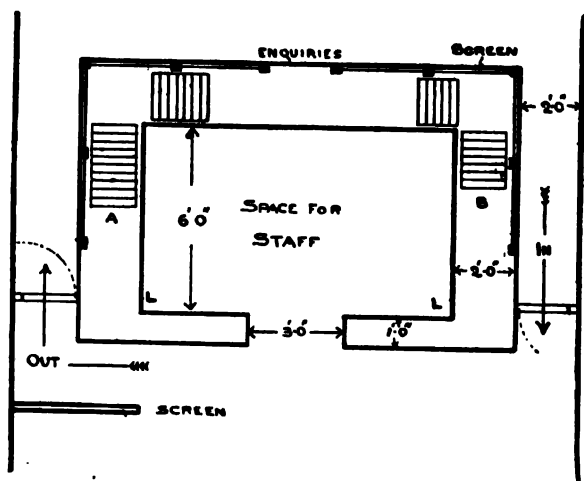

FIG. 25.—Single Open-Access Barrier (Section 160).

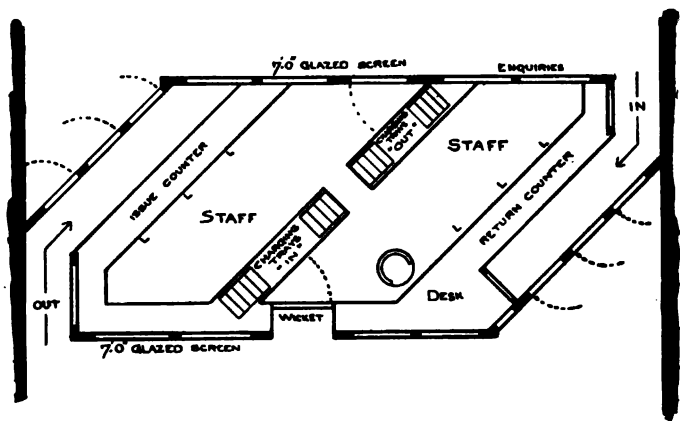

FIG. 26.—Plan of Triple Open-Access Barrier, Section (Section 160).

range for an ordinary library (Fig. 25), and a suggested design for a library doing a very large business requiring three assistants at each side (Fig. 26). By means of this second style

of barrier, which has not yet been tried so far as we know, it would be possible for six assistants, three at each side, to discharge and charge books at the rate of 1,000 per hour, a speed never required anywhere.

For all practical purposes a barrier with three wickets a side will serve for the largest single library in existence. The treadle latches such as are fitted in the open-access libraries

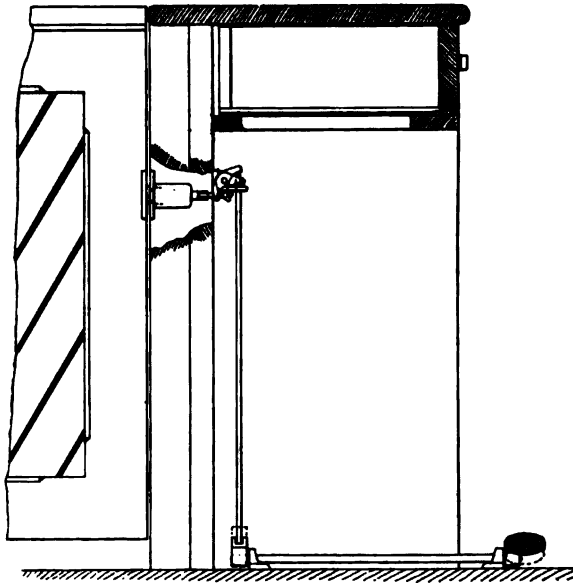

FIG. 27.—Treadle Latch for Open-Access Wicket (Section 160).

of Croydon, Clerkenwell, Hornsey, Darwen, Southport, etc., will be found well adapted for the purpose of controlling the wickets of both single and double open-access barriers (Fig. 27).

161. Sometimes a simple barrier is required in some kinds of reference libraries to separate bookcases from reading rooms. This may be either fixed or movable, and a good form can be constructed of ornamental ironwork, surmounted by a polished

Sec. 163] MISCELLANEOUS FIXTURES AND FITTINGS.

oak or walnut rail, about four to six inches wide, in the style of illustration (No. 28).

162. Screens.—In small libraries with a small staff it is often possible to obtain complete oversight of nearly every department by using glazed partitions or screens instead of brick internal walls. In cases where there is no roof weight to be supported, this is a very good arrangement, and is recommended for every building to which it can be applied. When such partitions divide rooms from each other, it is advisable to carry them right up to the ceiling to exclude noise. In other situations, as when dividing a room into two or more sections, the screens need not be more than eight or nine feet high.

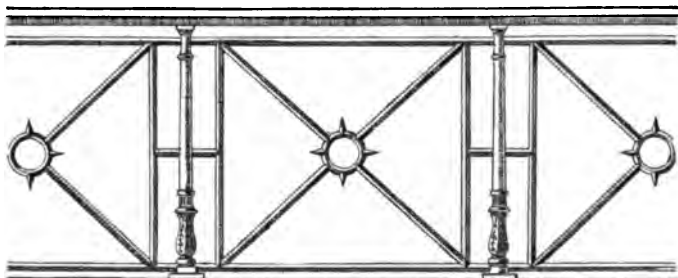

FIG. 28.—Iron Barrier for dividing Rooms (Section 161).

Clear glass should be used throughout, unless in the upper panels, not only for the sake of oversight, but of light.

163. Newspaper Stands.—The present conditions of printing and production seem to make the broadside style of newspaper a necessity in all countries, and till some radical change in machinery is introduced which will permit newspapers in pamphlet or small quarto form to be rapidly produced, large stands for the display of newspapers will have to be provided. Standard newspaper slopes either at right angles to walls or distributed over the floor of a newsroom are not recommended. In such positions they render oversight difficult and give the room a crowded appearance. It is necessary, however, in some cases, owing to considerations of light and convenience, to use

such stands, and the form and dimensions indicated below will be found useful (Figs. 29-33).

164. Wall slopes are in every way preferable to standards. They leave the whole of the centre of the room free; the titles



FIG. 29.—Double Newspaper Stand, Chelsea Public Library (Section 163).

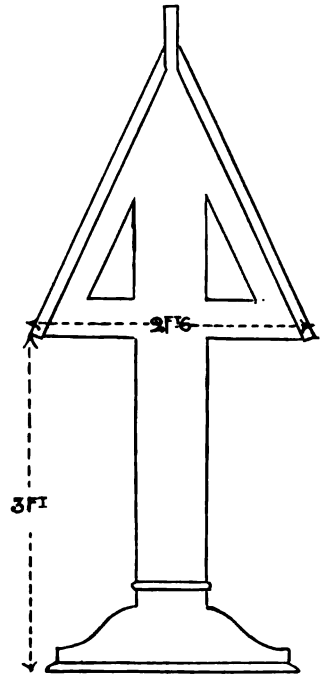

FIG. 30.—Double Newspaper Stand showing Dimensions (Section 163).

and whereabouts of newspapers are more easily noticed; and oversight is easy. Wall slopes should be made the same dimensions as standards, save, of course, that only one face will be necessary. The lower part of the slope should project

Sec. 165] MISCELLANEOUS FIXTURES AND FITTINGS.

eighteen inches to fifteen inches from the wall, so as to give a convenient angle for reading. Too great a slope is not desirable, as it tends to throw the top of the paper out of the reach and



FIG. 31.—Wall Newspaper Slope, with leaning Rail, etc., Fulham Public Library (Section 164).

eye range of short people. A small beading or projection at the foot of the slope is frequently of use in preventing papers from drooping.

165. Newspaper Fittings.—TITLES for newspapers should

be fixed on the stands over the centre of the spaces occupied by the papers. A title-board about six inches high should be provided for the purpose. It can be made to slide along a projection on the top of the stands if grooved on its under side. On this the name-tablets of the newspapers should appear in bold letters, not less than two inches high. These

tablets may be printed on paper or card or may appear on enamelled or metal tablets. There is a very large variety of such name-tablets on the market, and choice will not be difficult. It is a useful practice to attach to the fronts of the stands at intervals small bone, metal or card tablets intimating that papers must be surrendered to other readers after a certain period of warning has elapsed. (See Section 419 (33).)

166. HOLDERS.—There is a very large variety of rods, clips, and other means for holding newspapers on their stands, and the following illustrations will describe them better than words. A good form is used in the public libraries of Hammer-smith, Wolverhampton, Leicester, Clerken-well, Liverpool, etc., and consists of a pair of screw clips which can be readily adjusted to any height of paper. These Simplex clips are illustrated on the revolving rod,

Fig. 35. No. 34 is called the "Simplex" newspaper rod, and is fastened at the bottom by means of a screw turned by a key. It is used in the public libraries

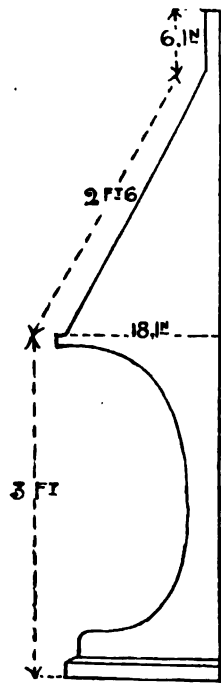

FIG. 32.—Wall Newspaper Stand, showing Dimensions (Section 164).

of Wolverhampton, Croydon, Hull, West Ham, Glasgow, etc. No. 35 is a revolving holder which can be adjusted to different sizes of illustrated periodicals, by means of the sliding screw clips. It is intended for periodicals like the *Graphic*, *Sketch*, *Architect*, etc., which frequently have large folding plates running

Sec. 168] MISCELLANEOUS FIXTURES AND FITTINGS.

across two pages, and which cannot be conveniently examined when the journal is secured to a stand. A special form of separate stand or easel (No. 36) is also made for such illustrated journals, which will be found useful when room is scarce on the other slopes.

167. Other fittings for newspaper slopes which are sometimes used are metal leaning bars or fences to keep readers from leaning on the papers and tearing them. These must be very strongly fastened at the foot of the slope in such a position

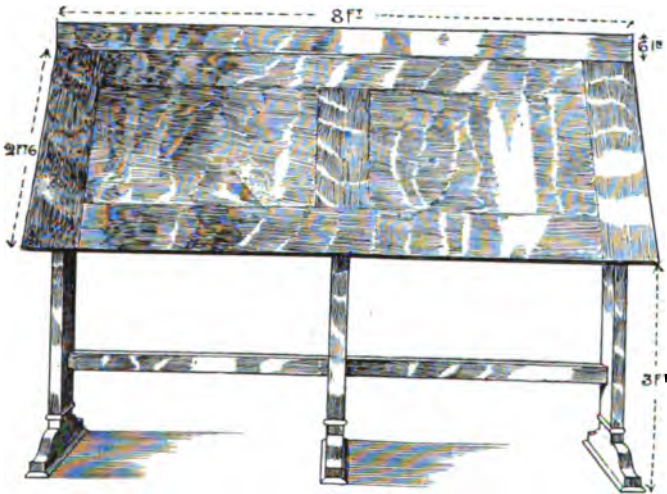

FIG. 33.—Double Newspaper Stand, showing Dimensions (Section 164).

as to project about four to six inches from the front. They should be held in strong brackets, as they have to support a very considerable weight. (See Fig. No. 31.)

The sticks and rods for holding single or several newspapers, such as are used for clubs and restaurants, are not suitable for public library use, unless under very exceptional circumstances.

168. Lifts.—Saving in very large libraries with many floors, neither passenger nor ordinary lifts for carrying heavy

weights are necessary. In a building with two or more floors, an ordinary lift for transporting parcels of books to the extent of perhaps two hundredweights, should be provided in a convenient place, preferably against a wall. Such lifts should have automatic brakes and simple raising and lowering mechanism.



FIG. 34.—Simplex Newspaper Holder (Section 166).



FIG. 35.—Revolving Newspaper Holder (Section 166).

In addition, it is often of greater service to have small, quick-running lifts or tubes capable of carrying one to six single books from floor to floor. In cases where lending library books are issued for reading in the reading room, this is a very convenient arrangement, and it also greatly facilitates the work of the

Sec. 169] MISCELLANEOUS FIXTURES AND FITTINGS.

staff by enabling messages and small articles to be rapidly transferred from place to place.

169. Speaking Tubes and Telephones.—Speaking tubes connecting every department should be provided in all new buildings, if telephones have not already been fixed. The telephone is much easier applied to an existing building, as there is less cutting about of walls required. But in new buildings speaking tubes can be provided quite easily, and they are simpler



FIG. 36.—Periodical Easel with revolving Holder. Back and Front Views (Section 166).

to work and less liable to get out of order than telephones. The telephone should be provided for every large public library, which ought to be connected with the municipal offices, the telephone exchange and its own branches. It is often possible for a public library to obtain a sufficient service by having a wire from the town hall switch-board to the library. The annual cost of this is only about one-fourth of the regular exchange service. For a complicated internal service of inter-communications, the telephone is much superior to speaking

tubes, as the switch-board system enables the user to communicate with any department without the need of extra tubes.

170. Floors.—Wood-block flooring is better than any other variety for all public rooms. It is less noisy, less liable to wear into knots, and much easier to repair. On the other hand, it costs more to lay down, as it requires a concrete foundation. But it is best in the end to face the extra cost for the after-advantage of comparative freedom from the noise of people walking about. The question of noise is a most important one in all libraries, but especially in large ones. The Birmingham Central Public Library is a type of a very noisy library, the fault being the construction of the entrance hall, with its stone or mosaic pavement, and the absence of any means of deadening the sound of frequenters trampling about. In marked contrast to this is the Central Reference Library at Manchester, where most effective means are taken to deaden noise, by the liberal provision of thick rubber mats, which line all the main gangways. The effect of this is to completely prevent the noise and shuffling caused by people walking about. But probably the Birmingham people feel that they have the advantage over Manchester in possessing comparatively noiseless streets! In reference libraries and reading rooms it would be an advantage to have a liberal supply of large rubber mats for all the principal gangways. They are certainly superior to linoleum and less liable to wear into holes. We have often thought that in Lancashire and northern towns where clogs are worn, it would be an immense advantage to have long corridors or passages, which are laid with mosaic pavement, covered by rubber mats. Public passages in libraries should have mosaic pavement, and the walls ought to be tiled with an ornamental dado, at least six feet high, which is very cleanly and prevents the match-striking nuisance. Linoleum should only be used for the floors of small rooms. In reading rooms where there is a number of tables and stands, it is very extravagant to cover the floors with linoleum in any of its varieties, because it gets worn out in the gangways long before it is half

Sec. 173] MISCELLANEOUS FIXTURES AND FITTINGS.

done under the tables. Besides, the cost of covering a large floor periodically with fresh linoleum is a very expensive process, which would be saved if proper wood-block floors had been put in at first. Wooden floors treated with "Ronuk" and "Dustless" are found to be comparatively free from dust, and are much easier to keep clean.

171. **Miscellaneous.**—In some libraries accommodation for CYCLES is provided outside the buildings, which is the proper place for such machines, in view of their tendency to do damage when placed against interior walls. In buildings which front busy main streets this kind of accommodation cannot be provided unless there is a courtyard or similar space in front. Some libraries which are infested by DOGS would be all the better of some effective means of keeping such animals outside. No doubt, if their owners were spoken to, they would agree to fasten them to hooks or rails outside the building, if proper means were provided. In America certain town libraries are partly supported by means of a dog tax, and in our opinion it is rather unfair—on the dogs—to post up a notice, "Dogs not admitted," when they are fully entitled, as taxpayers, to more consideration. The citizens of every State should be treated as equals in the eye of the law!

172. **TURNSTILES** for counting purposes are fitted up in several libraries, as well as in most museums, art galleries, etc. They should be placed in situations where their noisy clacking will not prove disturbing, if they are used at all.

173. Good English CLOCKS, with conspicuous dials, should be placed in every public room of a library. Where a number are provided, it is better to pay a small annual rent to have them wound, regulated and kept in repair, than to entrust them to the tender mercies of an unskilled caretaker. Libraries should also have a supply of small THERMOMETERS distributed and fixed throughout the rooms as a check upon the internal temperature, and it is a useful thing to provide a barometer as well.

174. REFERENCE LIST OF AUTHORITIES :—

Brown, J. D. Furniture. *See his* "Library Appliances," p. 12.

Burgoyne, F. J. Furniture and appliances. *See his* "Library Architecture," pp. 78-127.

Carr, H. J. Fixtures, furniture and fittings. U. S. Educ. Rept., 1892-1899, v. 1, p. 788.

For list of abbreviations see Section 88.

CHAPTER XII.

SHELVING AND ACCESSORIES.

175. The chief requirements of book-shelving are get-at-ability and adjustability. All authorities on library architecture are agreed that high shelves are an obstruction to quick service, and a danger to books, by placing them in a vitiated atmosphere with a comparatively high temperature. The old-fashioned wall-cases, twelve or fifteen feet high, which could only be reached by means of long ladders, are no longer recommended or installed, because of the labour they place upon the staff, their danger, and the fact that all the books on the upper shelves are not only inaccessible, but liable to a certain amount of harm. For these reasons modern libraries prefer to enlarge their floor area for the purpose of book-storage, and provide wall and standard bookcases which are within easy reach of the floor, thus placing the entire stock at the command of both staff and readers without the labour or danger of climbing up long ladders. It may be said, generally, that high wall-shelves should never be provided, unless with the provision of an iron gallery half way up, which can be reached by means of stairs.

176. The question of adjustability is just as important as get-at-ability. In every method or appliance which is introduced for library, or, indeed, any other work, the great principle of movability or adjustability should be preferred to fixity. The power of moving or changing without altering the character or shape of anything is of enormous advantage in every operation, and a very good illustration of the application of this power is furnished by the card catalogue, with its infinite capacity for expansion in every direction. Book-shelves should be as mobile

as cards in their own way, and should be so adjustable that a new shelf can be introduced or an existing one removed at any point where such a course is possible. The only advantage which fixed wooden shelves possess is that of comparative cheapness, but this is an advantage which, in a short time, is completely swallowed up in the inconveniences which arise through the impossibility of placing books of varying sizes in strict classified order on the shelves. Besides a great sacrifice of vertical space in some places, it will be found in a rapidly growing library that the carefully gauged shelves, at eight, nine, ten, or twelve inches apart, in every tier, cannot be made to contain all the books which ought to go on these shelves in their order. The day soon comes when the eight-and-a-half or nine-and-a-half inch book arrives which must go on the eight- or nine-inch shelf, and, because there is no means of making a slight adjustment, such books must either be shelved out of their order, or placed on their fore-edges. If such shelves are arranged throughout a library at a distance of ten inches apart to provide for contingencies, they will take all sizes up to demy 8vo, but at a great sacrifice of space, especially in the fiction shelves, where most of the books average about seven and a half inches. Any attempt at varying the distances between shelves in every tier, will lead to confusion in a strictly classified library. On the other hand, liberal spacing will result in the loss of a shelf in every tier, thereby reducing the total storage space by about one-eighth or one-ninth, according to the number of shelves in a tier. The balance of advantages lies with movable forms of shelving, and we strongly recommend that no other kind be specified or ordered.

177. The following diagrams give the usual dimensions for ordinary standard and wall bookcases, and may be taken as the unit from which a library stack can be built up according to any plan of arrangement. No. 37 represents a double-sided standard iron bookcase, 7 feet 6 inches \times 3 feet 2 inches \times 15 inches, which can be joined end to end to form cases of any length, or used in halves to form cases against walls.

Exactly the same dimensions can be used with wooden presses fitted with adjustable brackets or catches. In reference libraries the dimensions may be slightly varied, as the average book which must be stored is rather larger than in lending libraries. But the chief provision for folio and large quarto books should be in special cases arranged round the walls.

178. For standard reference cases the unit of size should be 7 feet 6 inches \times 3 feet 2 inches \times 18 inches. Special wall-cases should be the same height, but should have an arrangement

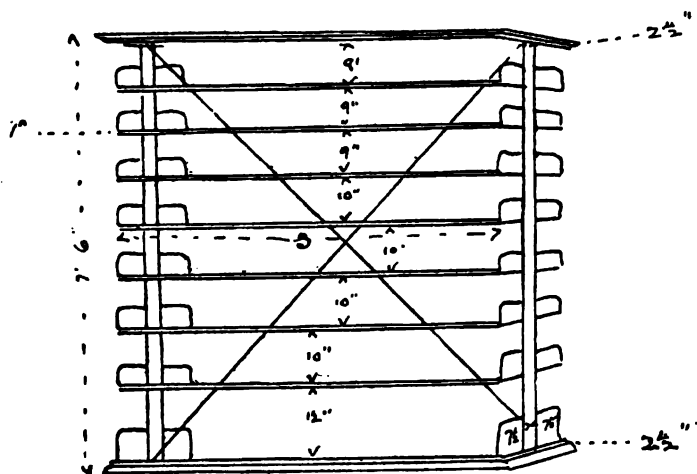

FIG. 37.—Rough Diagram of Standard Iron Bookcase, 7 feet 6 inches \times 3 feet 2 inches \times 15 inches.

for large books in the form of a ledged base projecting at least six inches from the front of the upper part of the case, about three feet above the floor (Fig. 38).

179. **Adjustable Shelf-Fittings.**—The old-fashioned varieties of shelf adjustments for wooden bookcases, such as pegs fitting into holes drilled in the uprights, one and a half or two inches apart; wooden or metal ratchets for carrying bars or rods for supporting the shelves; and similar devices, may be dismissed as unsuitable for modern library purposes. The

best-known adjustment is that known as Tonks', from the name of its patentee. It consists of metal strips, with perforations at inch intervals, let into grooves in the uprights, and designed to carry the shelves on four metal studs or catches, which engage in the slots or perforations. This method requires

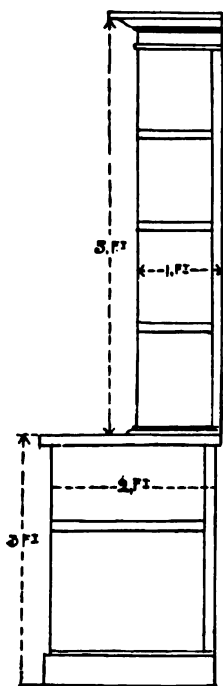

FIG. 38.—Wooden Wall Case with Ledged Base (Section 178).

very careful fitting, as the grooves in the woodwork must be deep and smooth enough to admit the catches, and each metal strip must be accurately inserted so that the slots will come level not only with those adjoining, but with those on the opposite upright. The least carelessness in fitting will cause shelves to rock and buckle, because not supported by catches all at one level. The subjoined illustration (No. 39) will show exactly the form of this fitting. It consists of: (a) shelf supported on standard; (b) perforated metal slip and stud; (c) stud or catch; (d) groove in wooden standard.

It should be noted that this variety of shelf-fitting does not give absolute adjustability, but only a movement of about an inch up or down, as may be required. Smaller adjustments are impossible by this or any other similar system.

180. There are various other methods of fixed shelf adjustments for wooden bookcases, English, American and German, but none of them possess any particular advantage over Tonks' variety.

Absolute adjustability in shelf-fittings, as applied to wooden cases, has been obtained in the English method, to be seen at various libraries in England. There are also various American systems.

Both of these forms are similar in principle to the absolute adjustments described under Section 181, but the English

system was the first to be patented, and, therefore, ranks as the pioneer of this type of shelf-fitting.

181. Metal Bookcases with Absolute Shelf Adjustments.

—The best and most used English variety of metal bookcase with absolute shelf adjustment is that which has been installed in the public libraries of Worcester, Shoreditch, Huddersfield, Perth, the Patent Office Library, London, and elsewhere. It consists, as shown in illustrations Nos. 37, 40, 41, of strong steel uprights, in which are formed continuous grooves, which carry and support shelf brackets designed to grip at any point

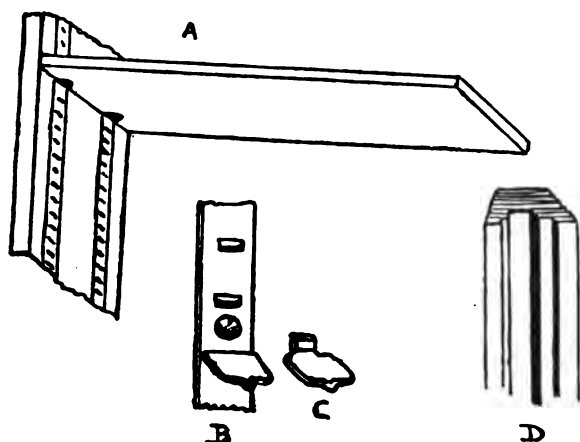

FIG. 39.—Tonks' Shelf Fittings (Section 179).

by automatic means. These brackets will slide up and down the uprights to any point, while a small controlling lever is depressed, but the moment this is released the bracket will become firmly fixed in place, and will remain there till again moved, whatever weight may be placed upon the shelf which it supports. These brackets can be pushed up without touching the controlling lever, and will always grip at the point where they are left. To push them down the controlling arm must be depressed as already described. The shelves for this type of case may be either metal or wood, but probably good

oak shelves will be found as satisfactory as any. Standard cases made in the dimensions given in Section 177 are usually divided down the middle, at the back of each set of shelves, by means of a wire-work grill. This does not obstruct oversight, light or air, yet serves to prevent books on one face of the standard from being accidentally or otherwise transferred to the opposite face. There are points of safety, convenience and adjustability about metal bookcases which make them preferable to all other forms.

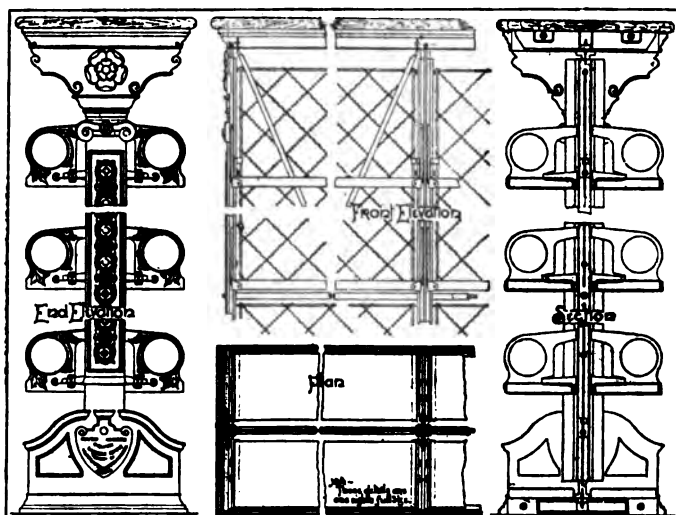

FIG. 40.—Details of Lambert's Adjustable Metal Shelving (Section 181).

182. A special form of this type of metal bookcase has been designed for book-storage in small spaces, and as applied to the India Office Library, London, and Bodleian Library, Oxford, has been found convenient and economical. The same shelf adjustment is used, but the presses instead of resting on the floor are swung from iron girders, so as to slide easily whenever wanted. These presses are swung closely side by side and drawn out, one at a time, as required.

A somewhat similar plan for increasing the storage capacity

was introduced into the British Museum many years ago, the chief difference being that the sliding presses go face to face with the existing standards, one here and there, instead of in solid rows as at the India Office. But these extreme methods of book-storage do not materially affect municipal libraries, which are under no obligation to store and preserve everything which comes along.

183. A more recent English system of adjustable shelving,



FIG. 41.—Adjustable Metal Shelving in the Patent Office Library, London (Section 181).

which was invented by Mr. B. Smith, Bath, is described below. The brackets are of cast metal, either malleable iron, brass or any suitable alloy, with a claw-like sleeve to envelop the standard, but fitting same quite easily. Cast to the sleeve will be noticed a swell of metal, A, into which is fitted a steel ball, B, which rolls up an inclined plane or pocket, uniting itself to the sleeve inside, thus the ball is always ready to impinge on the side or edge of the standard, being poised upon

a spiral spring, the tendency of which is always pressing the ball upward. Consequently, when the bracket is placed on the standard, the natural rolling tendency of the ball is to rise and wedge itself between the bracket and standard, which action instantly fixes the bracket to the standard without any other aid.

To lower the bracket press down the plunger, C, which

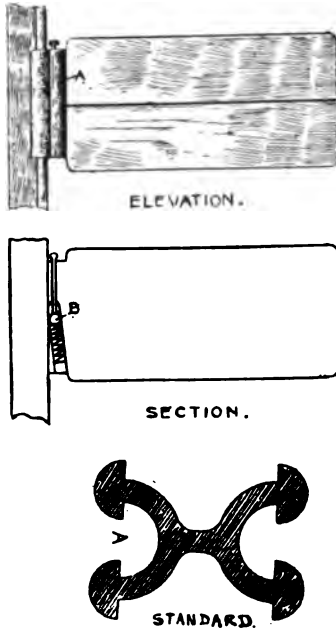

FIG. 42.—Brackets and Standard of Smith's Adjustable Shelving
(Section 188).

causes the ball to recede down the inclined plane, putting it out of touch with the standard. On releasing the plunger, the ball instantly comes into action, and the bracket is again fixed. To raise the bracket the plunger need not be touched, as lifting the bracket releases the wedge-like action of the ball.

184. It is not proposed to notice every variety of iron or metal bookcase which has been introduced, and it will be

sufficient to mention that in America there are several interesting forms supplied by the Library Bureau of Boston, and such firms as Stikeman and Green. The old gas-pipe stacking, so common at one time in America, is being gradually superseded by more convenient modern forms. We have not seen any recent American library plan which provides for this very simple and cheap plan of storage. Briefly, the pipe stacking consisted of iron-pipe standards in which holes were drilled at intervals of about an inch, and into these holes a stout iron-wire bracket was hooked, which supported the shelf. For storage purposes in basements and garrets, we know of no more effective or cheap bookcases giving a fair amount of adjustability.

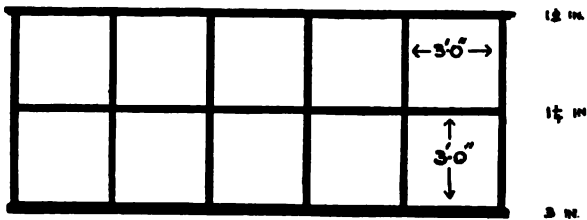

FIG. 43.—Rack for Bound Newspapers (Section 185).

185. Special Bookcases.—In Section 178 a form of special wall-case is described which is suitable for storing folio and quarto volumes. In very large libraries it may be necessary to provide additional storage space for bound files of newspapers, extra large folios and prints. Files of newspapers can be stored in a special form of double rack as illustrated in No. 43 above. As small libraries will only bind the files of local papers, the provision for this purpose need not be a very serious matter.

186. Large folio volumes are best kept flat on sliding trays or shelves. When they are kept upright they are very apt to suffer through the heavy leaves sagging and dragging at the binding. Valuable folios should always be kept in flat positions. A suitable method of storage is to provide a large double-sided

case, with a sloping top, which can be used for consulting the books. The shelves should be arranged to slide out and in on runners, and each shelf may have a brass handle on its fore-edge to enable it to be easily pulled out. The dimensions of such a case will depend upon the number of folios to be stored and their size, but the following illustration (No. 44) will be found suitable for all ordinary purposes.

This case will store about 150 to 200 folio volumes, according to their thickness, which is ample space for all ordinary municipal public libraries. The shelves of this case should be

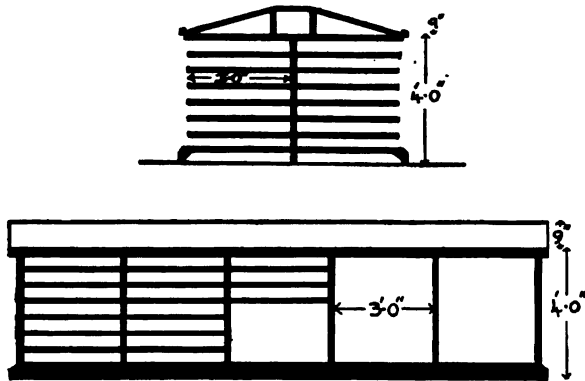

FIG. 44.—Section and Elevation of Case for Large Folio Books (Section 186).

covered on their upper surfaces with leather or thick cloth. A similar style of rack can be used for storing large collections of prints, the only difference being that the prints would be kept in special boxes as described in Section 376, which would take the place of volumes. A useful form of bookcase, which can be converted into a table or series of sloping shelves, is illustrated below (No. 45). This is a good form of stand in which to place new books or books on topics of the day.

187. In calculating the number of volumes which can be shelved in a given space, the following general rules will be found fairly accurate:—

Sec. 187] **SHELVING AND ACCESSORIES.**

Ten lending library books will occupy one foot run of space.

Eight reference library books will occupy one foot run of space.

Allowance must be made, in calculating from plans, for the



FIG. 45.—Convertible Table Bookcase, Clerkenwell Public Library
(Section 186).

space occupied by uprights, etc., and care must be taken to reckon dwarf bookcases only according to their capacity. If nine inches are allowed as the average height of books, which will give eight shelves to a tier seven feet six inches high, excluding

cornices, plinth or thickness of shelves, then a single-sided case of the dimensions shown in Section 177 will store 240 volumes in a lending library and about 192 in a reference library. A double-sided case will hold 480 and 384 volumes respectively.

188. Racks for Filing.—Wooden racks, or iron-pipe racks on the principle described in Section 184, may be used for a variety of purposes, such as storing unbound newspapers and periodicals, pamphlets, and all kinds of loose papers or bundles. Such racks are best made in a light, open form, so as to reduce the collection of dust to a minimum, while admitting air and light freely.

189. Galleries.—Galleries of iron are sometimes added to reference libraries and in other departments to provide a means of reaching high wall-shelves, and also to give additional accommodation for storage. They are a feature of the large stack rooms of American libraries, wherein the books are all massed together, gallery above gallery, and tier above tier. Unless there is some very strong reason, architectural or otherwise, galleries should be avoided in every public library where rapid service of readers is necessary. Saving for storing dead stock, galleries are not recommended in any situation, unless the pressure for book space is very great. When galleries must be provided, care should be taken to provide adequate approaches. If a straight staircase is out of the question, a circular iron one should be provided, wide enough to enable an assistant to go up or down comfortably with an armful of books. In some libraries the circular iron staircases are more like glorified cork-screws than proper means of getting up and down from a gallery or floor. It is much better to have stairways in a single flight, which will allow of two persons passing each other, and for this purpose they ought to be at least three feet wide.

190. Ladders and Steps.—In libraries with bookcases of the uniform height of seven feet six inches, long ladders will be unnecessary, but in cases where they must be used, step ladders are preferable to rung ones. A light form of step ladder which

Sec. 190] SHELVING AND ACCESSORIES.

is used in many public libraries and shops is illustrated below (No. 46). For all practical purposes this ladder will be found ample.



FIG. 46.—Lattice-Work Steps (Section 190).



FIG. 47.—Short Steps for Low Shelves (Section 190).

Short steps, for enabling the upper shelves of seven foot six inch cases to be easily scanned are made in various forms, some being

folding and others fixed. Both varieties as illustrated will be found useful.

191. In open-access libraries it has been found advisable to provide a continuous fixed step of wood or iron at the base of



FIG. 48.—Continuous Wooden Step and Handles, Hornsey Public Libraries (Section 191).

each bookcase, to enable readers to reach the upper shelves without using movable steps of the sort figured above (No. 47). A strong, wide iron rail projecting about four inches or six inches from the case, about nine inches or twelve inches above the

Sec. 192] SHELVING AND ACCESSORIES.

ground, has been found useful, especially when associated with a handle fastened to the upright at a convenient height above.

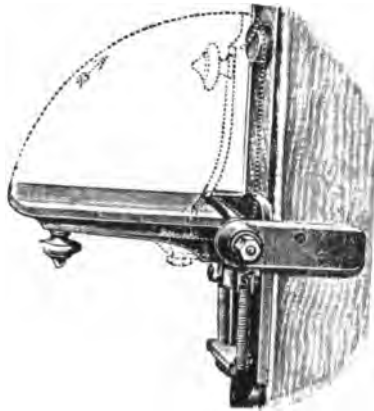

FIG. 49.—Automatic Closing Step (Section 192).

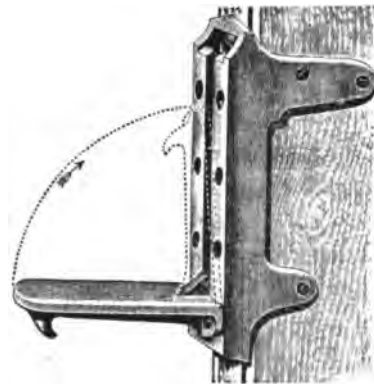

FIG. 50.—Adjustable Closing Step (Section 192).

The illustration (No. 48) opposite will give an idea of such a continuous step and handle applied in wood.

192. Detached steps secured to the uprights of bookcases, combined with handles, are very often used for staff purposes

in place of the ordinary movable wooden steps or ladders. There is one form with an automatic adjustment which enables the step to spring up flat against the upright out of the way when not wanted, as figured in illustration No. 49. It is not necessary to fit this into the uprights, and to cut away the wood-work in order to let it into its place. Another variety with a different adjustment is shown in Fig. 50. There is still another variety, used at Hull, Kilmarnock, etc., which is always in position for use, but which also possesses an automatic adjustment enabling it to be brushed aside harmlessly by any one passing, and to return to its "ready" position at once. This form can be attached to any ordinary wooden upright by means of screws,

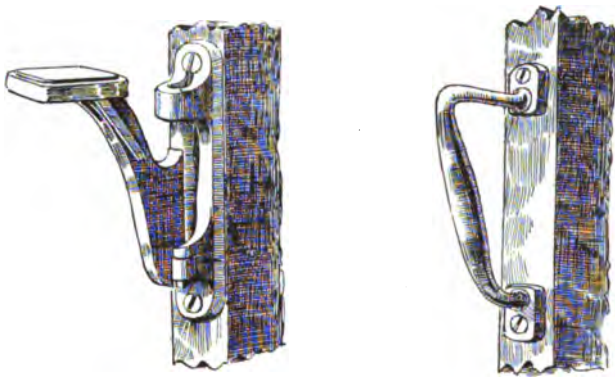

FIG. 51.—Swinging Step with Improved Handle (Section 192).

without cutting away or fitting. The handle supplied with this has a superior shape and grip (Fig. 51).

193. Shelf Accessories.—For the purpose of maintaining order on the shelves and marking particular divisions or classes, various devices have from time to time been introduced.

DUMMIES are used to indicate the temporary absence of books, or to show that particular works, because of their large size, are located on some other shelf. The simplest form of shelf dummy for classification purposes is a block of wood about 6 inches \times 4 inches \times $\frac{1}{2}$ inch, painted white, or covered with white paper on the edge, and lettered with the title of the book which it

Sec. 195] SHELVING AND ACCESSORIES.

represents. The title should be written on each of the six-inch faces, in case the block gets reversed, and should also bear a plain direction to the location of the book it represents.

194. For books temporarily withdrawn a piece of millboard covered white on one side may be used in the form shown below (Fig. 53). This should have the author, number and title of the missing book written on the white side. One board of this sort can be used over and over again for different books, by simply adding the new title and obliterating the old one. This



FIG. 52.—Block Shelf Dummy for Book Shelved out of Order (Section 193).

board can also be used instead of the block above illustrated (No. 52) if space is a matter of moment.

The object of the tail in this form of board is to prevent the board from disappearing behind or getting lost among the other books. When placed between two books, with the projection overhanging the front of the shelf, it will always stick out so as to be readily seen, while it cannot very readily be pushed deep into the shelf because of the projection.

195. LABEL-HOLDERS for keeping all kinds of classification

or other labels in place upon the fore-edges of shelves, close to the books which they indicate, are made in various forms. An old form was made out of tin or thin japanned iron, with a pair of flanges on the upper and lower edges to take a card-label.

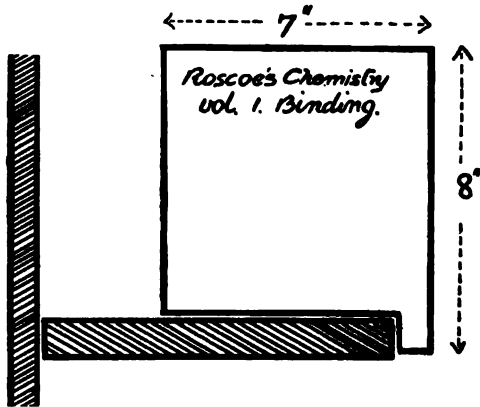

FIG. 53.—Millboard Shelf Dummy for Withdrawn Book (Section 194).

This was screwed or tacked on to the edge of the shelf and shifted when necessary. Another form of this holder is made precisely the same as regards the turned-over flanges to form



FIG. 54.—Flanged Label-Holder (Section 195).

grooves, but without the screw holes, and has in addition a long projection to slide under the books on the shelf so as to keep in place. This can be moved easily, of course, but it is very apt to be pulled out when books are removed.

yet effective shelf label-holder is made from strips of transparent xylonite bent in a rectangular form, and pinned or screwed to the under side of the shelf as illustrated (No. 56). This can be made to fit snugly into shelves with either square or rounded edges, and keeps the labels quite clean, as it covers them over. The advantage of this form of label-holder is that



FIG. 55.—Label-Holder with Tongue (Section 195).

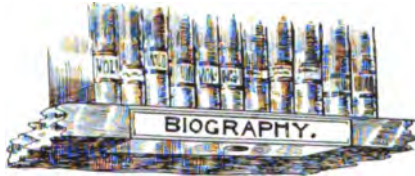

FIG. 56.—Xylonite Label-Holder (Section 195).

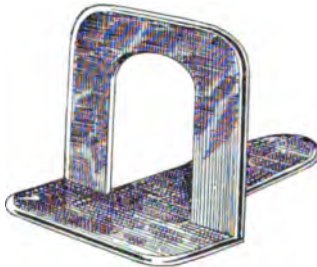

FIG. 57.—Tongued Metal Book-Rest (Section 196).

it can be cut with a pair of scissors or a knife to any size, if wanted only for simple shelf or class numbers. It is also easily adjusted or changed with but little trouble.

196. BOOK-RESTS AND SHELF GUIDES.—Practically every librarian has invented a book-rest at some period of his or her career, and there is consequently the less need for describing

more than one or two typical devices. The best-known form is the ordinary rectangular metal rest, which is made in several styles in japanned iron. No. 57 is the best form, though it is objectionable, because books are apt to be impaled upon the sharp edge and damaged, and occasionally the rest itself is lost. A better, though slightly more expensive, form is No. 58. By



FIG. 58.—Flanged Metal Book-Rest (Section 196).

reason of the flanged side there is no danger of a book being damaged, and this side can also be used as a classification guide, if wanted to mark off alphabetical or other divisions. Sometimes, in open-access libraries particularly, it is desirable to use divisional guides to indicate where one class begins and another ends, and this form will be found useful. Plain wooden blocks

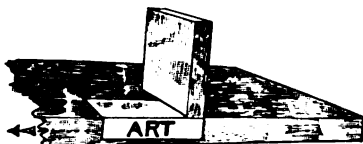

FIG. 59.—Combined Book-Rest and Shelf Guide (Section 196).

mounted on metal angle pieces which can be made to act as label-holders are also useful in classified libraries. The illustration (No. 59) below will show the form of this device.

197. Another form of book-rest or support is sufficiently described by the illustration which follows (Fig. 60).

198. Book-Stands and Carriers.—For desk and table use

Sec. 199] **SHELVING AND ACCESSORIES.**

there are two very convenient and adjustable book-stands which will be found useful in public as well as private libraries. One is the American stand with adjustable wire compartments, which is useful for keeping books handy for desk use or for sorting out cards, etc.

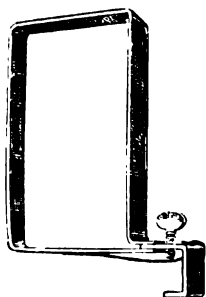

FIG. 60.—Yale Book-Rest (Section 196.)

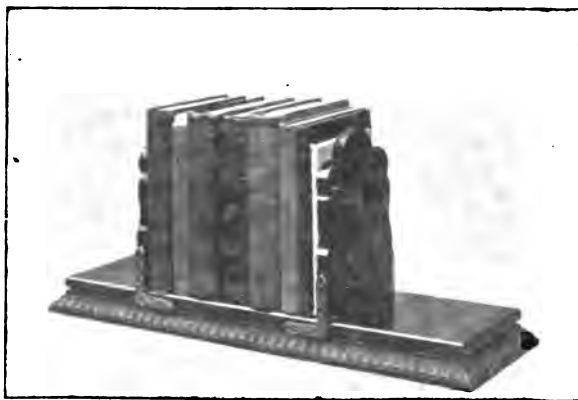

FIG. 61.—Adjustable Book-Stand.

199. The other is the English adjustable book-stand which is largely used for displaying and carrying about a few books for committee or consultation purposes. As a table book-holder, this is probably the best and strongest form ever invented. As shown in the illustration (No. 61) the uprights

slide and firmly grip a large or small number of books, according to the capacity of the holder. This same contrivance has been adapted as a library book-carrier, by having strong

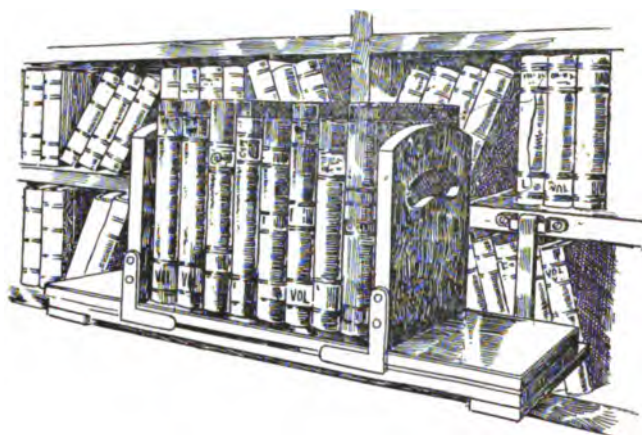

FIG. 62.—Book-Carrier temporarily hung on Bookcase (Section 199).

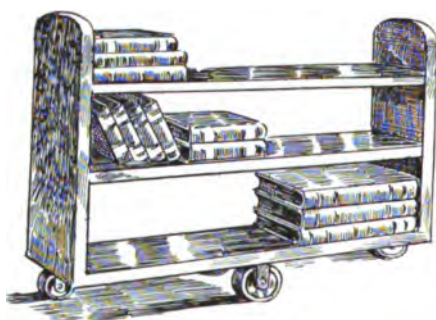

FIG. 63.—Book-Truck (Section 200).

hooks attached, which fit into staples affixed to the fronts or ends of bookcases. They are very useful for classifying and arranging books awaiting replacements or shelving (Fig. 62).

There are other forms of book-holders and carriers with fixed

Sec. 200] SHELVING AND ACCESSORIES.

upright ends, but they are not so satisfactory as the adjustable forms described.

200. In large libraries a book-truck will be found a useful appliance for moving quantities of books about, either for purposes of service or location or cataloguing. The design illustrated above (No. 63) will sufficiently explain this device.

CHAPTER XIII.

. LIBRARY INDICATORS.

201. When libraries were first established under the provisions of the various Acts of Parliament, two things happened as a matter of course in every district: a building, suitable or otherwise, was provided; and the readers in a town increased in number to an enormous and unprecedented extent. Straited means generally led to the provision of a cramped and inconvenient building, in which the space set apart for books was often ridiculously inadequate, with the result that lofty shelves were the rule, which secured economy of storage at the expense of rapidity of service. Previous experience in mechanics' institutes, or similar libraries, was found by the new librarian a useless criterion for public library needs, and especially as a guide to the multitude of readers and the variety of their demands. Delays in service occurred continually, and the poor librarian was often abashed or offended at the freely expressed scepticism with which the public received his reports of books being *out*. From these factors was evolved the *idea* of the indicator, which by-and-by took practical shape as a machine for saving the legs of the librarian and his assistants from frequent and fruitless climbs to high shelves, and enabling readers to satisfy themselves that books were actually in use. The original indicators were intended only for showing, by means of numbers, the novels which were out or in, but since then a considerable number of libraries have applied them to all classes.

202. The indicator, as a library tool, is almost entirely an English appliance, and it is somewhat curious, considering their love for, and extensive use of, mechanical contrivances, that

American librarians have never taken kindly to it. Various abortive experiments have been tried at Boston and elsewhere with indicating devices of several patterns, but the almost universal opinion of American librarians is against indicators in any shape or form. Practically this holds good as regards colonial and foreign libraries generally, though one or two Canadian and Australasian libraries have adopted indicators of an English design. In England, on the contrary, the invention of these appliances has gone on unremittingly for thirty-eight years, and there must be at least twenty different varieties, each possessing a certain amount of merit or ingenuity, and many claiming to be the best, or possessing some point of superiority over all others. But it is not quite accurate to assume, as has been done by various writers, that the indicator system is used "almost universally" in English public libraries, or is even to be found in a "majority" of them. There is another point which should not be lost sight of in estimating the popularity of different charging systems, and that is the fact of the use of the indicator being restricted in many places to fiction only. Some librarians use indicators only *as* indicators and not as registers, while in some towns indicators will be found in central libraries and not at the branches, or *vice versa*. Again, some of the very largest and most used public libraries in the country—Manchester, Liverpool, Salford, etc.—do not use indicators at all. It is, therefore, quite evident that this particular system is not so universal as our American cousins and others assume.

203. A library indicator, as its name implies, is a device for indicating or registering information about books in such a way that it can be seen either by the staff alone, or by the public and staff both. The information usually conveyed to the public is some kind of indication of the presence or absence of books, and the methods of accomplishing this almost invariably take the form of displayed numbers, qualified in such a way as to indicate books *in* and *out*. Thus, small spaces on a screen may be numbered to represent books, and their presence in the library indicated by the space being blank, or their absence from

the library shown by the space being occupied by a card or block. Or, colours may be used to indicate books in and out, or a change in the position of a block representing a book. No doubt the idea of the mechanical indicator was early evolved from the needs of the first public libraries. The first practical application of it was in 1863, when Mr. Charles Dyall, then Librarian at the Hulme Branch of the Manchester Public Libraries, and now Curator of the Walker Art Gallery, Liverpool, had one made for actual use by the public and the staff. This seems to be the very earliest English indicator, and Mr. Dyall is entitled to full credit as the pioneer inventor.

204. This indicator was comparatively small, being a case about nine inches deep, with a glazed front. At the back, behind the glass, small shelves were provided, wide enough to carry little blocks bearing the book numbers on both their ends. These shelves were divided by small stops or partitions, which limited the blocks to the spaces required for indicating single books. Black stripes were painted vertically on the back of the glass, in such a way as to hide half of the spaces in which the numbered blocks were kept. The blocks being arranged consecutively, so as to occupy the clear spaces between the black stripes, borrowers could see what numbers were available, the visibility of the number being an indication that the book represented was in. When a book was issued, the assistant slid its number-block behind the black stripe, so that it was concealed from the public, and thereby indicated *out*. This process was reversed when the book was returned. The charge was made in a ledger, and the contrivance was used as an indicator pure and simple, and for fiction only. A description of it was published in the *Manchester Guardian* early in 1863. It is somewhat interesting that the very first indicator should have so far anticipated modern needs as to provide for this double method of indicating, because in the next indicator to be described only the staff was considered.

205. Another variety of indicator has often been referred to, but has hardly ever been correctly described, either as regards its construction or working. It was invented by Mr. F. T.

Barrett, of the Mitchell Library, Glasgow, in the winter of 1868, while he was in the Reference Department of the Birmingham Public Library. To his recollection, and to that of Mr. Dent, of Aston Manor, we are indebted for the following particulars. The indicator was intended for staff use only, and applied to the works of fiction and to no other class.

The indicator consisted of a large board in which were drilled vertical columns of peg holes, above a hollow ledge or tray fixed on the indicator about thirty-two inches from the floor. Long stripes of printed numbers in progressive order were fastened alongside the columns, so that a number appeared against every hole. A specially made metal peg was fitted into every hole, and remained there while the book represented by the number was in. On the issue of a book the peg opposite its number

80 ... ○
 81 ... ○
 82 ... ○
 83 ... ○

was withdrawn and placed in the ledge. On the return of a book a peg was replaced in the hole, opposite the book number.

206. Mr. Dent's Indicator, of 1869, was the first to combine indicating with charging, and it suggested several succeeding devices. His account of it is interesting, as it mentions the existence of an early form of card indicator which has since been re-invented in various styles. "A certain Mr. Christie, Librarian of the Constitution Hill Branch Library (Birmingham), about 1868 constructed a small rack with cards bearing the titles of a selection of the books in history, science, etc., open to the public, and the presence of one of these tickets in the rack indicated that the book was 'in'. If any one wished to take one of the books thus shown, he lifted the ticket out of the rack (there was no glass in front) and handed it to the attendant who put it in a box till the book came back, and then

replaced it almost anywhere in the rack. This gave me an idea that the cumbrous system of day-book, posting-book, and constant piles of books to be marked off as returned might be done away with, if tickets in a rack representing every number in the library were substituted for book-entry," etc. Mr. Dent's improvement upon this idea consisted in the provision of a series of numbered shelves in columns, with spaces between to take the borrowers' cards when the books were out. The back of the borrower's card was to be ruled to allow of numbers

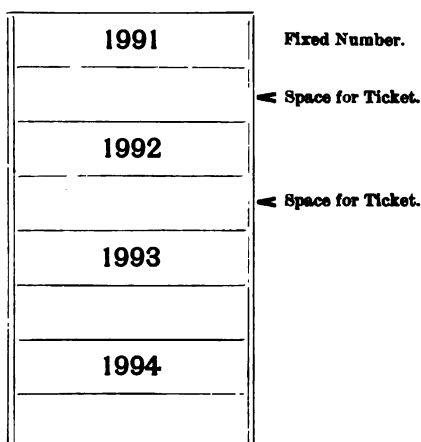

FIG. 64.—Diagram of Dent Indicator (Section 206).

and dates being pencilled thereon, and, of course, the presence of a borrower's card under a number indicated a book "out".

This idea of Mr. Dent's was described to a number of librarians, among others to Mr. Barrett and Mr. Elliot, of Wolverhampton, and though it was entirely concerned with charging, not indicating, there can hardly be a doubt that it contained the germs of several indicators since invented. The year following the publication of Mr. Dent's idea saw the practical accomplishment of a combined charging and indicating device which is well known to most librarians.

207. This was the ELLIOT INDICATOR, 1870, which is very fully described in a pamphlet entitled "A Practical Explanation of the Safe and Rapid Method of Issuing Library Books, by J. Elliot, inventor of the system". Wolverhampton, 1870. This pamphlet gives diagrams and descriptions of the Elliot Indicator in substantially the same form in which it exists at the present day. It differs from Mr. Dent's idea in having the numbers alongside the ticket shelves or spaces, instead of over them, and in having a specially thick borrower's ticket with coloured ends to show books out and overdue. The indicator

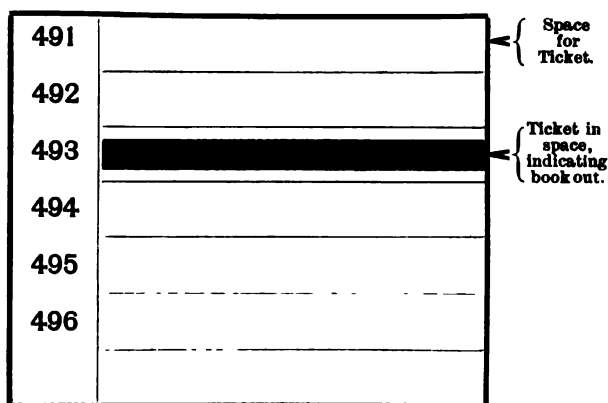

FIG. 65.—Diagram of Elliot Indicator (Section 207).

is a large frame, divided into columns by wide uprights carrying 100 numbers each, which correspond with the little shelves, formed of tin, dividing each column.

There are 100 shelves and numbers in every column, and the indicator is made in several sizes, according to the width of the borrower's card used. The public side is covered with glass. The method of working is simple. The borrower scans the indicator till he finds the space opposite the number he wants vacant. This indicates that the book he wants is in, and he then hands his ticket to the assistant, stating the number of the book he requires. The assistant enters the book number

and date of issue in the borrower's card, and inserts it in the indicator in the space against the number. The book is then fetched, and before issue it is registered on a specially ruled day-sheet, by means of a stroke, to record the day's circulation for statistical purposes. When the book is returned its number directs to the space on the indicator occupied by the borrower's card, which is withdrawn and returned to the owner, when all liability for fines is cleared. Overdues are detected by means of differently coloured ends to the borrowers' cards, or the periodical examination of the indicator. Good examples of this indicator in actual use are to be seen at Wolverhampton, Newcastle-on-Tyne and Paisley.

208. The best description of the Kennedy Indicator, 1875, is published on a large folio four-page statement written by Mr. John Maclauchlan, Chief Librarian of the Dundee Free Library, and issued on 22nd September, 1879. This sheet is headed: "Description and Method of using Kennedy's Indicator, invented for the Dundee Free Library in January, 1875, and constantly used therein since July of that year," and contains illustrations of the counter and details of the construction of the indicator. The following description is abstracted from it: "This contrivance consists of a series of upright glazed frames so placed as to be easily inspected by the public at the front, or glazed side, and by the library attendants at the back. . . . Each frame is divided into twenty vertical columns by slips of mahogany, and each of these slips is again sub-divided into 100 sloping slits by pieces of stiff millboard [now zinc], tightly held in saw cuts made in the sides of the mahogany slips. . . . As the lower edge of each piece of millboard is a little above that of the next one below it, sufficient space is visible of their lower ends in front, and of their upper ends at the back of the indicator, to receive the catalogue number of each book in the library, printed in bold figures and pasted at the end of the millboard [zinc] strips with strong paste." Each borrower is provided with a ticket measuring five and three-eighth inches by one inch, ruled as follows:—

| | | |
|-------------------------------|-------|---|
| This end coloured Yellow. | | |
| 2,179. | | |
| G. Kerr, 1 Earl Street. | | |
| $\frac{2}{3}$ | 1,300 | G |
| $\frac{1}{5}$ | 1,045 | I |
| $\frac{2}{8}$ | 6,557 | K |
| This end coloured Red. | | |

FIG. 66.—Ticket for Kennedy Indicator.

The reverse side is ruled the same, but the end spaces are coloured green and blue respectively. When a book is asked for, a slip is filled up by the borrower, after he has ascertained by reference to the indicator that it is in.

As mentioned above, the indicator consists of a series of diagonal slits about one inch wide, arranged in columns in such a manner that when a borrower's card is inserted in a slit, its end covers up the book number at the end of the slope. A small portion of this indicator will give an idea of its working:—

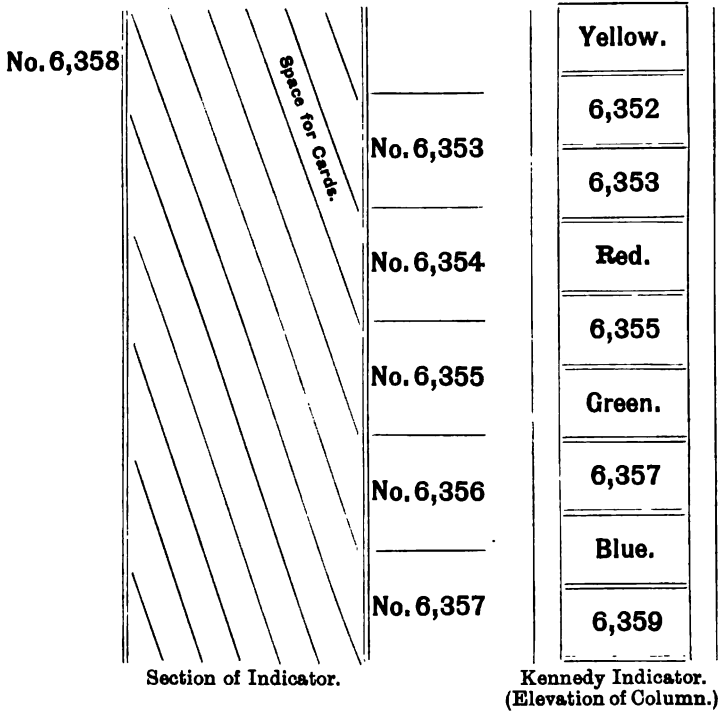

FIG. 67.—Diagrams of Kennedy Indicator (Section 208).

The four different coloured ends on the cards are for the purpose of indicating overdues, a new colour being used in every period of a few days. When a book is returned, its number and class letter direct to its place in the indicator, and the assistant, with the aid of the "Form of Return," discharges the old book by simply removing the borrower's card from the slit, and charges the new one by entering its number, date of issue and class on the borrower's card, and placing it in the slit representing the new book issued. The record of volumes issued is made up from the borrowers' application forms.

The inventor of this form of indicator was Mr. John Kennedy, a member of the Dundee Library Committee, who had his attention called to Mr. Elliot's Indicator by Mr. David

Jobson, junr., another member of the Dundee Committee. Mr. Kennedy made a careful examination of Mr. Elliot's Indicator, and as a result devised his own form, as one which was more economical in the space occupied and free from certain objections put forward by the Dundee Committee. It was introduced in 1875, on a purely non-commercial basis, and models have been freely supplied to other libraries desirous of adopting a similar form of indicator. It is claimed in the statement from which our information is derived, that "the so-called 'Morgan Indicator,' exhibited at the Librarians' Conference in October, 1877, is precisely the same as Mr. Kennedy's, and has apparently been copied, without acknowledgment, from the indicator erected in the Branch Libraries at Sheffield, by means of a model sent direct from Dundee".

209. The indicators described hitherto have been in principle chiefly a series of fixed numbers, qualified by means of pegs alongside them, or tickets placed under, alongside, or over them. The only exception is the indicator of Mr. Dyall, wherein the disappearance of a number indicated the book out. This was accomplished, however, by the removal of the number-block from its column, thereby causing a considerable waste of space. To Mr. F. T. Barrett, of the Mitchell Library, Glasgow, belongs the credit of having invented (in 1876) the movable number, on the economical principle of effecting a change within the space occupied by the number itself. He describes it as follows: "The frame was a series of uprights, say one-half inch broad, in both sides of which sawmarks to the depth of one-eighth inch were cut at intervals of, say, one-third inch, all the way down—opposite, of course. The indicator was a strip of zinc, $1\frac{1}{2}$ inch \times $\frac{3}{4}$ inch, with one-eighth inch indents at corners of one end extending rather over one-fourth inch.—



The projecting tag carrying the number was turned down at right angles, and the slip so formed ran in the saw-cuts in the uprights. When the book was in the numbered end was



turned to the public. When out the slip was turned in the saw-cuts, showing the number to the staff behind. The back of each upright was to be provided with a column of numbers 1 to 00, with the full number at head of each, 8,501."

A model of this indicator was shown at the first International Conference in 1877, and became part of the Museum of Library Appliances formed at that date, but seems to have vanished without leaving a single trace.

210. As noted in connection with the Kennedy Indicator, there is some doubt if the ordinary Morgan Indicator with the diagonal slots is not copied from the Kennedy one, with various little modifications. The Morgan Indicator (1876), as at one time worked at Derby, is thus described: "On a book being issued to a borrower whose card has been presented, its number is at once entered on the dated slip above the date, and the borrower's number *below*. The number of the book and the date are then entered in pencil on the back of the borrower's ticket, and the ticket with the proper colour for the week showing slipped into the indicator. This covers the number on the public side as well. The slip is put on a file at the counter and cleared at short intervals by a junior, whose business it is to arrange the slips in numerical order. Next morning the slips are checked by the indicator, counted and classified, and the results entered in the statistics book. They are then blended numerically with the others of the current quarter. I know of no statistics likely to be wanted which cannot be readily obtained from these slips. Their blending takes the juniors an hour daily on the average."

The borrower's card differs from the Kennedy one only in shape, and in one or two minor particulars. It is ruled like this:—

| | | |
|------------------|--|----------------|
| Reverse Crimson. | DERBY PUBLIC LIBRARY. | Reverse Green. |
| | <div style="display: flex; justify-content: space-between;"> <div style="width: 45%;"> <p>Yellow. Name.....</p> <p>Address.....</p> </div> <div style="width: 10%; text-align: center;"> <p>No.</p> </div> <div style="width: 45%; text-align: right;"> <p>Pink.</p> </div> </div> | |

FIG. 68.—Ticket for Morgan Indicator.

and the back is a plain white surface on which the issued book numbers are entered. A model of this indicator was shown at the Library Conference of 1877, and at the Oxford meeting of the Library Association in 1878.

211. **COTGREAVE INDICATOR, 1877.**—This indicator was invented by Mr. Alfred Cotgreave, the present Librarian of West Ham, when he was Librarian of the Wednesbury Public Library, in 1877. At the time of his invention an Elliot Indicator was in use at Wednesbury, and it was owing to the misplacement of borrowers' tickets in this indicator that Mr. Cotgreave's attention was drawn to the question of providing some remedy. He tried various schemes to prevent such mistakes, but ultimately decided that movable numbered blocks, filling up every space in the indicator, would best meet the difficulty. An indicator on this principle was thereon designed, and later the numbered blocks were replaced by wooden blocks having a record book attached. The Handsworth Public Library first adopted this indicator. Subsequently the wooden block was superseded by a metal slide in which the little book carrying the record of issues was placed. In this form the Cotgreave Indicator has existed for a number of years, and it is so well known that it is almost unnecessary to give a description of it in detail. An account of its structure and working from one of the descriptive circulars issued in connection with it will, however, enable any one to gather a good idea of its appearance and use:—

“It consists of a wooden or iron frame, fitted with minute zinc shelves, generally 100 in a column. Upon each of these shelves is placed a small metal-bound ledger (3 inches

× 1 inch), containing a number of leaves, ruled and headed for the number of borrower's ticket, and date of issue; also date of return or other items as may be required, numbered or lettered at each end, and arranged numerically in the frames. One part of it is also lettered for entries of date of purchase, title of book, etc. The metal case has turned-up ends, and the numbers appear on a ground coloured red at one end, and blue at the other, one colour showing books *out*, the other books *in*; other colours may be used if preferred. The *out*

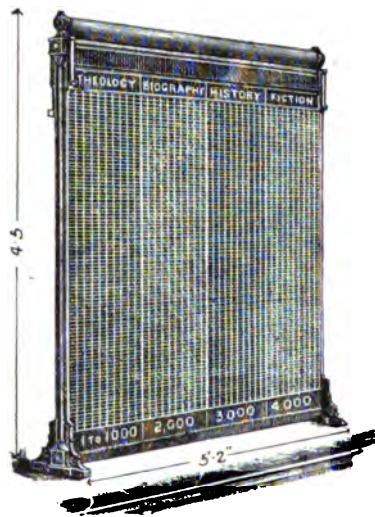

FIG. 69.—Cotgreave Indicator (Section 211).

numbers can be covered altogether with a date slide if required. The change of colour is effected by simply reversing the ledger in the indicator frame. The public side of the indicator is protected by glass.

“The *modus operandi* is as follows: A borrower having chosen a book from the catalogue, consults the indicator, and finding the required number to be on *blue*, denoting *in*, asks for the book corresponding, at the same time tendering his library ticket. The assistant withdraws the indicator ledger, makes the necessary

entries, inserts borrower's ticket, and reverses the ledger, which then shows the *red* colour, signifying *out*. He then hands out the book asked for. The borrower's ticket will remain in this number until he changes his book, when this ticket will, of course, be transferred to the next number required, and the returned number will be reversed again, showing by the *blue* colour that the book it represents is again *in*, and is immediately available to any other reader requiring it. The entries need not be made at the time of issue, but may stand over until a more convenient time.

"When a book is not required the ticket is returned to the borrower, and acts as a receipt, exonerating him from liabilities."

There are many ways of working this indicator in order to obtain certain records or notifications of overdues, and nearly every library has some modification of its own. It is by far the most used indicator of all the varieties in existence, and has been largely adopted in English libraries.

It is not necessary to trace the history of the indicator in any further detail, because, with one exception, the forms described comprise all that have been introduced to any extent in English public libraries. Such inventions as the Robertson, Scull's "Bristol," Bonner and Crowther Indicators are confined in use to the libraries in which they originated, and the same must be said of the Wright-Stanlake and other even more modern forms. The only other indicator which has been introduced to any extent was invented in 1894, and has several features which may be described here.

212. This consists of a series of wooden blocks, each of which is numbered with 250 numbers in gilt figures, and each number has a slot under it large enough to hold a book-card with red coloured or white ends, bearing the same number as the slot. These blocks can be built into columns of 1,000 with the numbers running consecutively, the whole being lodged in a glazed frame as shown in illustration No. 70. This indicator differs from other varieties in having the numbers qualified by the red or white line of the card under the numbers to indicate books *in*; when the slot is blank, the book is *out*. "The with-

drawal of the book-card is the method of indicating books out, and it is the union of this card with the borrower's card which forms the basis of the subsequent registration. When a book is issued the assistant withdraws the card from the recorder and places it in the reader's ticket, which is formed like a

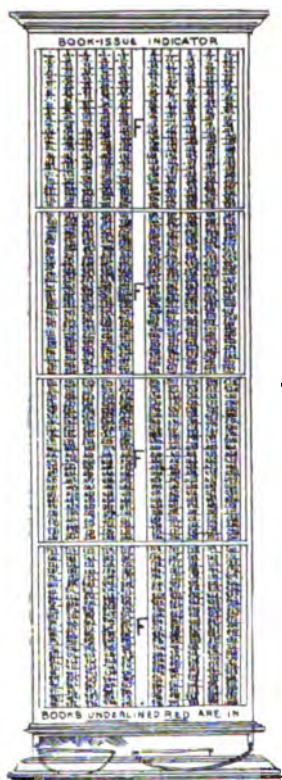

Fig. 70.—Chiver's Indicator
(Section 212).

association in 1895, and published in *The Library* for 1896, with illustrations. This was a practical proposal for an adjustable indicator in which its size should be limited by the number of books in actual *circulation*, and not by the number in *stock*. There is a very important point here, as a library with a stock

pocket, fetches the book, stamps it with the date of issue, and so completes the transaction at the moment of service. Afterwards, the readers' pocket tickets containing the book-cards are assembled and arranged according to classes in numerical order. They are then posted, by book and reader numbers only, on to a daily issue sheet or register, and the date of issue is stamped on each book-card, if this has not already been done at the moment of service. The conjoined book- and reader-cards are then placed in a tray bearing the date of issue, in the order of classes and book numbers, or in one series of book numbers as may be needful." In other respects, this charging system resembles the card methods described in Section 445.

213. The only other indicator which is designed on an entirely different principle from any of the foregoing is the Adjustable Indicator proposed by the author in a paper read before the Library As-

of 30,000 volumes would require an indicator occupying about thirty-eight feet run of counter space. If it never had more than 4,000 volumes out at one time, these could be shown on the limited indicator above named within a space of not more than six or eight feet. This is a most important question, and it is inevitable that, in many libraries where conditions and feeling are opposed to progressive changes, this continual growth of indicator space will force library authorities into the serious consideration of more advanced and liberal methods.

214. The whole question of indicators in British public libraries is one which will sooner or later have to be faced in most places which have committed themselves to this form of apparatus. Since the first introduction of indicators as the sole method of charging and recording, several important modifications have been imposed upon the system. It has been found in many libraries that the indicator is not required for any class of literature, save fiction, and in this way a wise limitation has become recognised. That it will spread is undoubted, because library authorities must see the folly of purchasing an expensive machine which in its non-fiction section only records about 20 or 25 per cent. of the issues, although it represents from 60 to 70 per cent. of the stock. The rise of a newer and younger school of librarians, who have ideas as to public rights, and more satisfactory and scientific methods of supplying public needs, has also acted as a check upon the extension of indicator systems within recent years. Such men can see for themselves that, if large towns like Manchester, Liverpool, Birmingham, etc., can serve their readers efficiently, by means of simple card or ledger methods of registration, and the largest and busiest American public libraries achieve equally good results with similar means, the need for a mechanical barrier between readers and staff is neither vital to the safe working of a library, nor more helpful to the public than other methods. A very remarkable change has also taken place both in Britain and America as regards the policy of giving readers of all kinds more liberal conditions of direct access to the shelves, and this has been a powerful factor in determining librarians and

committees to thoroughly examine the whole question of public service before blindly adopting a system whose chief merits are its long-standing acceptance in Britain as the *only* system, and the assiduity with which it has been advertised on purely commercial lines.

215. Indicators are occasionally used for recording and indicating the issue of the parts of periodicals, both in lending libraries and reading rooms. The former variety is usually a modification of the ordinary book indicator, with the substitution of columns of months under the titles of the magazine, instead of numbers. The reading-room indicator simply shows what periodicals are in use or available, in cases where they are kept behind a barrier instead of being spread over tables or racks. There are examples of this indicator at the Public Libraries of St. Saviour's, Southwark, and Clerk-

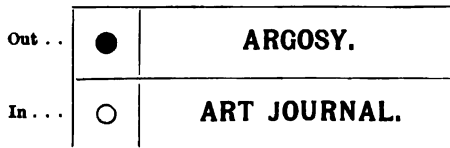

FIG. 71.—Diagram of Periodicals Indicator (Section 215).

enwell, Finsbury. The principle is simple. The titles of magazines are mounted upon narrow blocks of wood, arranged loosely in columns so as to be adjustable, within a glazed frame. The back of this frame is open to the staff only. Against the end of each title a hole is drilled to take a round peg which is coloured black at one end and white at the other. The white ends are shown when a magazine is *in*, and when it is issued the peg is reversed to show the black end. This indicates *out*.

216. As a substitute for indicators, and an approach to open access, many libraries provide a show-case for new books on the lending library counter, to enable readers to see the additions as they are made. In some libraries these show-cases are not glazed on the public side, so that the readers have the additional privilege of examining the new books as well as

merely seeing them. Certain libraries, like Birkenhead and St. George-in-the-East, Stepney, have whole departments of books arranged behind wire or glass within seeing distance of the readers, and they have the option of choice by bindings and titles, which if not much better, is as good as choosing from meagre catalogue entries, and at any rate gives the semblance of freedom and closer touch with the books.

CHAPTER XIV.

FURNITURE.

217. The rate limitation in British libraries, such a prolific source of evil in regard to every method and matter connected with the establishment and management of public libraries, is partly responsible for the inferior furniture usually provided all over the country. It is this limitation which causes committees to borrow less than their requirements demand, and the mistakes made in overbuilding for the sake of a gorgeous exterior make such serious inroads on the funds that in many cases only enough money is left to provide the cheapest and commonest kind of deal furniture, which is utterly unworthy of the building containing it. Again we urge that whatever amount is raised for buildings, at least 10 per cent. of it should be appropriated for furniture, and by furniture should be understood only movable articles like tables, chairs, desks, cabinets, office furniture, etc.

218. The effect of shabby fittings and furniture on the minds of visitors is not such as will tend to the promotion of discipline, nor will it instil respect for the library into the minds of rate-payers and readers. A fine building, appropriately fitted up, will not only impress the average visitor, but it will cause the citizens to take pride in the library as a town's institution. A fine building shabbily fitted up inside will probably have quite a different effect. While a very strong distinction is to be drawn between luxury and propriety in such matters, we think a much better purpose will be served by procuring good and substantial fittings and furniture, than by wasting on extravagant exteriors most of the money available for building.

219. Reading Tables.—For general reading rooms the tables should not be too long, nor, if readers are to sit on both

sides, too narrow. A table to accommodate, say, eight persons, four on each side, should be 8 feet long \times 3 feet wide \times 32 inches high. The rails of reading-room tables should not be made so deep as to interfere with the comfort of persons using them, and cross rails connecting the table legs near the floor level should never be used, as these only serve as foot-rests. A certain number of tables should be made with desk or sloping tops, as shown in illustration No. 72. Oak, walnut or other hard woods should be used for library furniture. Pitch pine



FIG. 72.—Desk-Topped Table, with Double Slope (Section 219).

is not recommended, as it invariably splits as the resin dries out.

220. In reference libraries, especially in those designed for students with open access to the shelves, quite a liberal space should be allowed. It has not hitherto been the practice, save in large libraries like the British Museum, to give reference readers as much table room as is desirable, nor to give students the amount of isolation which they require. The general policy has been to seat readers at long tables and separate them from their opposite neighbours by means of a screen, as is done at the British Museum, and in libraries like the Cornell University,

Ithaca, New York. This method, which is depicted in Figs. Nos. 73 and 74, gives a certain amount of seclusion, but it does not provide a sufficiency of room for books and materials. Then, of course, no municipal library can hope to compete with the British Museum in the provision of expensive furniture.



FIG. 73.—British Museum Reading Table with Desk and Rack (Section 220).

To ensure that each student reader will obtain a liberal share of room, combined with comfort and isolation, we strongly recommend a system of separate tables in the form illustrated (No. 75), or in some way which will secure the same accommodation. The plan of making the table the unit of space

instead of the readers will automatically solve the problem of how much room to give each reader.

The table illustrated gives the following accommodation :—
Six square feet of free table-top with a sunk ink-well.



FIG. 74.—Reading Tables, Cornell University Library, U.S.A.
(Section 220).

A back board six inches or nine inches high to prevent overlooking by neighbours, and provide space for ruler and pen racks, shelves, clips, etc.

A sloping writing desk can be added if required.

Shelves under the table for holding extra books, materials or an overcoat.

An extension slide to pull out and form a book-rest or supplementary table for papers.

In addition, if space permits, an umbrella holder can be fitted to the left-hand support of the table, so that each reader will be isolated and self-contained.



FIG. 75.—Special Reading Table for Students (Section 220).

221. Periodicals, Tables and Racks.—The question of the methods of displaying periodicals and magazines is discussed in Chapter XXXIV., and it is not necessary to consider the matter of policy here. Various kinds of tables have been designed for displaying magazines in covers in a fixed place, and for simply enabling them to be easily read in the ordinary way. Where periodicals are kept in racks, tables in the forms

described in Section 219 will be found sufficient. In cases where the tables have to perform the combined function of racks and tables other arrangements are necessary. There are many forms of rack-table, but only three need be described. The first,

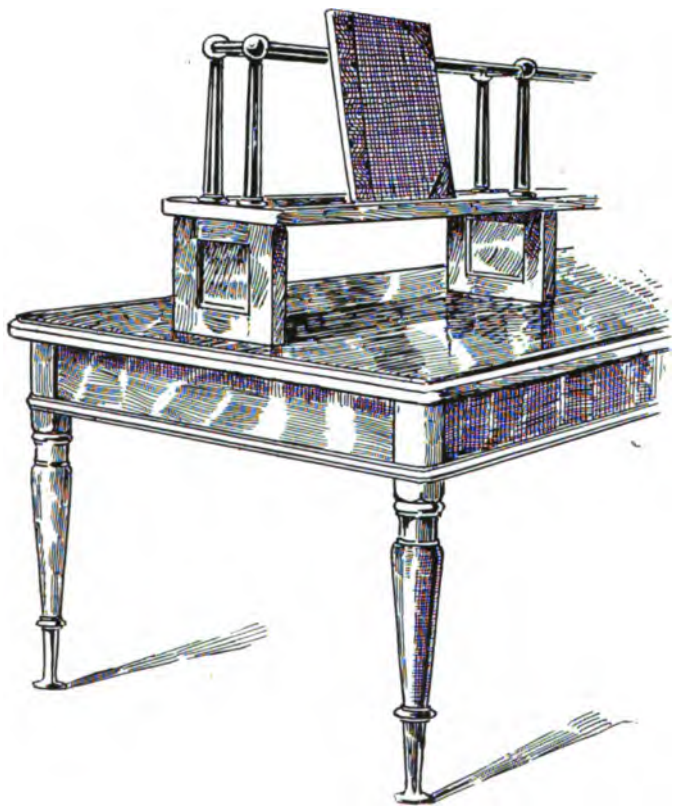

FIG. 76.—Periodical Rack on Elevated Platform (Section 221).

which is used in several large libraries, provides a large elevated rack above the table-top, on which the periodicals are placed, so as to free as much as possible of the table surface for readers. This is illustrated above (No. 76).

In this form of table-rack the periodicals are not fastened to

their places, and, owing to the varied sizes of the periodicals in an elevated position, they give a somewhat untidy appearance to a room.



FIG. 77.—Periodical Rack on Table-Top (Section 222).

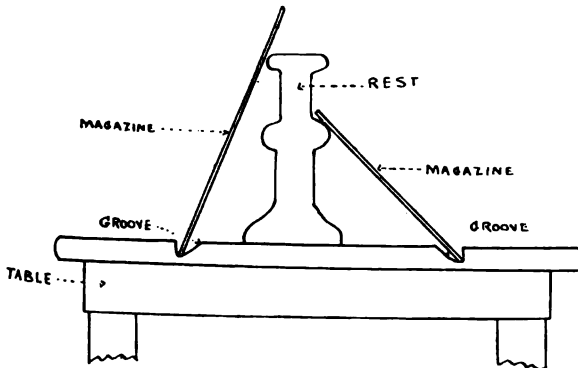

FIG. 78.—Table Rack for Periodicals (Section 223).

222. A less conspicuous form, and one equally effective, dispenses with the elevated platform, and the rack simply rests

upon the table-top as illustrated (No. 77). If necessary, the periodicals can be fastened to the rack by means of cords or chains encased in rubber or leathern thongs, and the contents of each table can be displayed upon an adjustable titles list in the form described in Section 484, fastened to the ends of the rack.

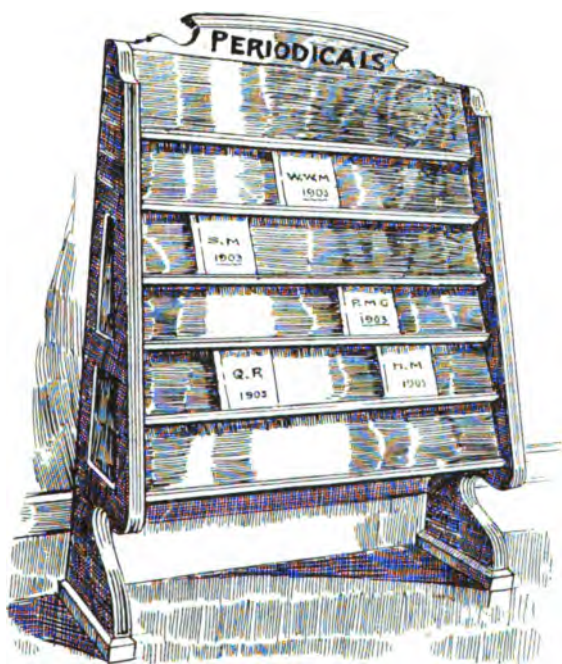

FIG. 79.—Kensington Periodical Rack, with Magazines resting on Narrow Shelf (Section 224).

223. Another form of periodical rack-table, which is even more economical and just as effective as those already illustrated, is shown in the illustration opposite (No. 78).

This makes a more effective division between readers seated on opposite sides of the table, and tends to prevent conversation and the interchange of periodicals. The periodicals can be fixed by means of chains or cords if thought necessary.

224. Periodical racks are made in a large variety of forms, and the following illustrations are typical of most of the devices used (Figs. 79-81 and 115).



FIG. 80.—Cotgreave Periodical Rack, Fulham Public Library (Section 224).

A smaller rack for railway time-tables is illustrated on p. 188 (No. 82).

225. A variety of table-rack which we have not seen used could be built up by a combination of ordinary flat tables (Section 219), adjustable reading desks or easels (Section 226), and screw

clips (Section 166) or revolving rods (Section 166). Each periodical would be fixed to one of the adjustable easels, and the easels could be secured down the centre of the tables. This gives the power of rearranging the easels in any order on the



FIG. 81.—Rack for Odd or Occasional Periodicals, Clerkenwell Public Library (Section 224).

tables, and would be very effective, though undoubtedly the most costly arrangement.

226. Reading Easels.—In connection with these special tables, book stands or easels for keeping a number of books open

at once will be found useful. It very often happens that a student desires to compare his authorities, and an easy means of keeping several books open at a given place is necessary. The book easels shown in our illustrations show the best forms yet devised. No. 83, which is made entirely of metal, has the advantage of leaving the table surface practically free and unobstructed, while the automatic means provided for keeping

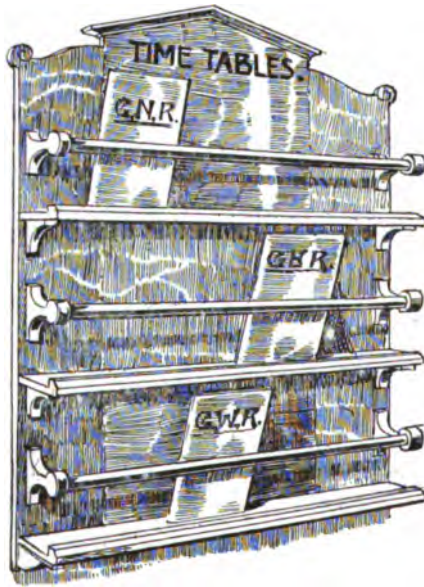

FIG. 82.—Railway Time-Table Rack (Section 224).

books open at any place, irrespective of the number of leaves, is of great utility.

No. 84, constructed of wood, is also a light useful article, but as it rests the book close to the table surface more obstruction is caused, while the leaf-holders are not automatically adjusting.

There are various other forms of wooden reading easels, but they are light articles designed to fold up, and will not carry large reference books with any great degree of security.

227. The Americans have brought out quite a variety of wire and metal book-holders, designed to carry dictionaries,



FIG. 83.—Metal Reading Easel for Books of different Sizes (Section 226).

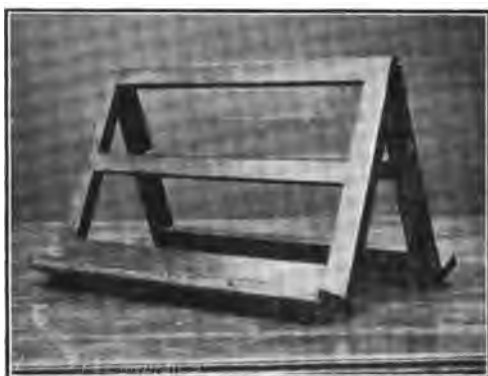

FIG. 84.—Wooden Reading Easel (Section 226).

encyclopædias, etc. These take the form of standards resting on the floor, and range in price from ten to three dollars (£2 to 189

12s.) each. The "Noyes" wire form is the cheapest, and the "Lambie" and "Kalamazoo" the dearest. The Columbia dictionary-holder is illustrated below (Fig. 85).

228. Chairs.—There is such an immense variety of library chairs that the chief difficulty becomes that of selection. A strong chair is best, and in all ordinary situations arm chairs are preferable, as they give an automatic spacing of elbow room which renders calculation unnecessary.



FIG. 85.—Columbia Dictionary-Holder (Section 227).

229. Where the space between tables is very restricted the chairs should be fastened to the floor, so that there can be no blocking of gangways. An effective plan is that adopted at the Mitchell Library, Glasgow, of having revolving arm chairs mounted on pedestals secured to the floor. These have the one great disadvantage of being non-adjustable. Readers cannot pull them a little forwards or backwards, and thus such

fixed chairs have the defect of all fixed things—they cannot be moved to suit varying conditions. A better form for a crowded situation is an ordinary strong chair of good design anchored to the floor by means of a stout cord. Each chair has a stout staple screwed under the seat in the centre, and a similar staple is screwed into the floor at a suitable distance from the table front, and corresponding in situation with the staple in the chair seat when placed in position. Lengths of stout window cord are then cut and provided with swivel hooks at either end,



FIG. 86.—Chair with Anchorage Attachment (Section 229).

which are fastened to the staples on the floor and on the seat, allowing a sufficient length of cord to admit of a fair amount of play and movement when anchored.

This kind of anchorage allows of a chair being moved backwards, forwards or sideways, and readers can get to and from their seats without trouble. Arm chairs are not recommended for this style of fastening.

All kinds of chairs should be shod with rubber or leather pads to deaden the noise of movement on the floor. There are several varieties of such pads to be obtained from furnishing firms.

230. Hat rails of metal or wood are sometimes provided under all chairs; a very necessary provision in wet weather. The continental custom of uncovering the head when entering public buildings is not yet very common in the United Kingdom, but readers should certainly be encouraged to do so by having the means of bestowing their headgear placed easily at hand. General hat, coat and umbrella stands or racks are not popular in public libraries, and need not, as a rule, be provided. But some kind of hat and umbrella holders should certainly be provided in connection with the chairs. A very good combination



FIG. 87.—Arm Chair with Hat Rail and Umbrella Holder (Section 230).

arm chair is shown in the accompanying illustration (No. 87). This provides hat and umbrella accommodation, and may also have attached to the left, or both arms, a folding wire-work drop holder, in which to place completed papers, light books or other articles not wanted to litter the table-top (Fig. 88). Of course, such chairs with these additional accessories could only be used in situations where there was plenty of room.

231. Every library should buy more chairs than are required. This will enable the chairs to be removed for cleaning purposes in batches of a dozen or more, their places being taken

by the spare ones. This will prevent the seating accommodation from being reduced during any cleaning operations.

232. Desks.—For staff purposes ordinary school desks will be found ample. These are provided with side flaps and a locking compartment. A Canadian form with shelves and a lock-up desk flap, with pigeon holes, suitable for going against a wall, is a useful type of desk for assistants doing a special class of work, as the desk flap can be locked back out of the way, and so protect the papers or work.



FIG. 88.—Chair with Folding Tray or Shelf (Section 230).

233. For large libraries, where an elevated superintendent's desk is necessary, the combined desk and drawer cabinet used in the Mitchell Library, Glasgow, has many advantages.

234. Librarian's Office.—The room appropriated for the use of the librarian should be furnished with plenty of shelving and a standard revolving bookcase to range close up to the desk.

A good roll-top desk should be provided in preference to an old-fashioned cylinder table with push-in table-top. These tables give ample accommodation for current work, and include a filing division which will take about a year's correspondence.

A comfortable revolving chair should also be provided to go with the desk.

A side table of the ordinary kind should also form part of the properties of a librarian's office, together with a few ordinary chairs, a clock, waste-paper basket, etc.

235. **Committee Room.**—The furniture for a committee room should include a suitable table, chairs, hat and coat rack and umbrella stand, clock, a few book shelves for exhibiting new books or donations (one similar to that described in Section 186 will do), and the usual fittings for such a room. A large map of the district should also be framed and hung here. In some libraries separate lockers are provided for each member of committee, and this is a good thing to do if there is room for a suitable cabinet.

236. **Staff Room.**—The principal requisites for this room are a table, chairs, hat stand or pegs, lockers, a cupboard and a gas-stove suitable for boiling and grilling. Each member of the staff should be allowed to have a separate lockfast drawer, and anything which may be suggested for the comfort and convenience of the staff, within reason, should be provided. A mirror and clothes and shoe brushes should be provided, and in the lavatory towel rails or rollers.

CHAPTER XV.

CHARGING, FILING, REGISTRATION AND COPYING APPARATUS.

237. **Charging Appliances.**—The theory and practice of charging or registering books on loan are described in Chapter XXXI., and the present section will accordingly be confined to the description of apparatus. The indicator, in most of its

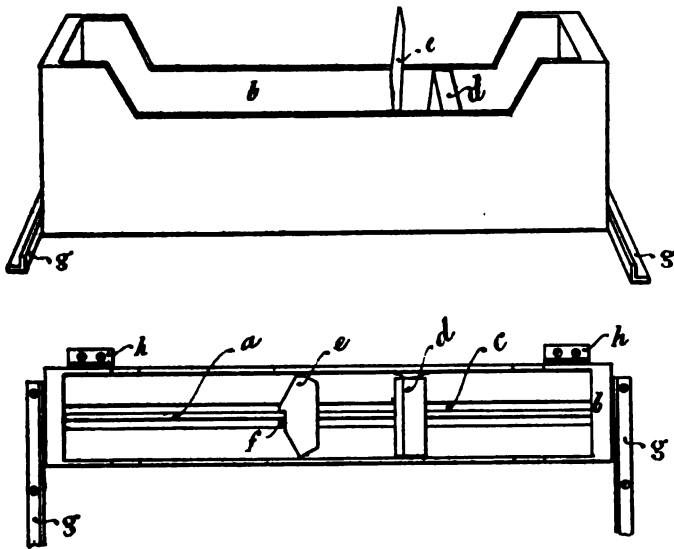

FIG. 89.—Elevation and Plan of Card-Charging Tray (Section 298).

varieties, is already treated of in Chapter XIII., and it only remains to deal with the apparatus connected with card charging. The most important part of a card method is the tray for holding and displaying the cards, and of this there are a number of

kinds in use in libraries using indicators and in those working without them. For many reasons, but above all for economy of space, it is best to use a comparatively small-sized charging card, the advantage being that all the accessories such as trays, guides, etc., are correspondingly small, cheap and easily handled.

238. A standard size of card tray made of wood is shown in Fig. No. 89.

This tray (*b*) is provided with a rod (*a*) for securing the guides (*e*) in a continuous slot (*c*) at the bottom, to carry and secure the slot-fastening (*f*) of the guides (*e*). It has out-away sides to facilitate the handling of the cards; a back slide or block (*d*) to retain the cards at any convenient or required angle; angle-bars and catch pieces of brass (*g* and *h*) to secure a series of trays firmly in place, and prevent upsetting or knocking about. For every kind of card charging, whether in connection with an indicator or without, this style of single tray, capable of indefinite expansion, is preferable to drawers or frames divided into compartments. Each tray will hold with its guides 1,000 cards, and, when divided up into hundreds, any number can be found quite rapidly.



FIG. 90.—Guide for Card-Charging Tray (Section 238).

239. The guides are generally made from steel, enamelled and figured, or from vulcanised fibre bearing the numbers stamped upon them. Every charging system of this kind should have a set of nine guides for each thousand numbers, numbered simply 1, 2, 3, 4, 5, 6, 7, 8, 9, or having the hundreds running progressively throughout, 100, 200, 300, 400, etc. There should also be at least two complete sets of date guides, numbered from 1 to 31 inclusive, a set of alphabetical guides (for unclaimed borrowers' cards) from A to Z, and the miscellaneous guides for fines, marked 1d., 2d., 3d., 6d., etc., "Overdues," "Renewals," "Guarantors Notified," etc. All these are necessary for working card-charging as described in Chapter XXXI.

240. It is advisable to provide a card-sorting tray in libraries

Sec. 242] CHARGING AND COPYING APPARATUS.

with a large stock and issue, and this may be a simple rack divided into narrow compartments representing thousands, as shown in the annexed illustration. The compartments need not be more than an inch wide, as the cards can lie just as easily on their edges as flat, and with greater economy of space. Where fiction is kept in a separate series of trays, or the book-issue cards are classed, then, of course, some modifications will be required both in book-issue and sorting trays.

Filing Apparatus.—Methods of filing are described in Chapter XXIV. The present section deals only with appliances.

241. CABINETS for filing letters are patented in a very great number of forms, from elaborate structures with mechanical accessories to comparatively simple trays. The best-known systems—those of Shannon, Amberg, Record, etc.—consist of

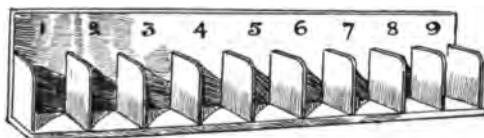

FIG. 91.—Card-Sorting Tray (Section 240).

boxes or trays containing alphabetical index sheets or cards, and various mechanical means of securing letters and documents in place, with means of expansion when necessary. Large files of this kind are intended to hold a long series of letters, and are more suited to the needs of business houses or public departments in which correspondence forms a principal part of the everyday work. The methods of Shannon, Amberg are well known, and can be obtained in different sizes to suit varying requirements. It should be noted that the desk mentioned in Section 234 possesses the means for filing, in a handy form, all ordinary correspondence likely to arise in a library during a year.

242. BOXES for filing letters and documents made in the form illustrated (No. 92) on next page will be found just as useful and convenient as more mechanical devices for all ordinary pur-

poses. All they require is a series of division cards to preserve the alphabetical order, and they have the merit of being cheaper and handier than most other filing methods.

243. **PORTFOLIOS** and **BINDERS** for preserving documents can be had in all sizes and styles. Plain portfolios in the form of covers, without fastenings of any kind, save tapes to close their edges, are useful for holding and classifying documents for temporary purposes. It is a convenient plan to reserve such portfolios or suitable boxes for each particular piece of work in hand, and to slip all relative papers into them. They can be marked on the outside by means of paper labels, and will be

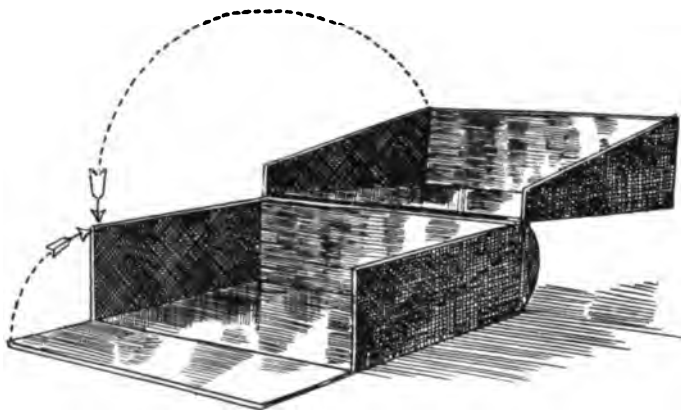

FIG. 92.—Box for Pamphlets, Letters, etc. (Section 242).

found of much service for temporarily storing papers, etc. The same kind of portfolios, but with mechanical binding arrangements, can also be used for the same purpose.

244. **CLAMPS** and **CLIPS** for holding papers folded and endorsed or flat are sometimes useful in libraries. The simplest form of clamp is two pieces of cloth-covered board, one of which is hinged about two inches from one end. These clamps are held by means of stout rubber bands or tape.

245. Clips mounted on boards, suitable for hanging up, and those known as apron files are sometimes used for accounts and invoices.

Sec. 249] CHARGING AND COPYING APPARATUS.

246. **WALLETS and POCKETS**, with alphabetical divisions printed on them, are not so durable or convenient as the other devices mentioned, though they are sometimes used for filing scraps or other cuttings.

247. **Copying**.—A **LETTER COPYING PRESS** should form part of the equipment of every library. This appliance is too well known to require either description or illustration. Beyond stating that any stationer can supply it, and that it is best to procure one of good quality, large enough to take a foolscap folio book, there is nothing more to be said on the subject. Letter books made of Japanese paper are better than ordinary kinds. As an adjunct to a letter copying press, a pen-carbon copying book should be obtained. On this a copy can be retained at the moment of writing, and any kind of ink, pen or paper can be used. For the less important letters of a library, or for orders, etc., this style of copying book is recommended.

248. **Typewriters**.—There are so many competing typewriters in the market, that it is by far the best plan to entirely ignore the claims and blandishments of agents, and select a machine after an actual trial of several varieties. Most agents will send machines on approval for a week or two, and the librarian, or operator who will have to do the work, will very soon discover which one best suits his requirements. There are many uses for a typewriter in a large library, apart altogether from its value as an aid to clear and rapid correspondence. For card or slip catalogue entries, lists of additions, lists of new books for committees, and all work into which manifolding enters, it will be found of the utmost utility. A typewritten catalogue entry or public notice is generally much plainer and easier to read than a manuscript one, and for that reason alone the machine soon pays itself. The cost of a new typewriter of good make ranges from £20 to £21, but there are cheaper makes, of course.

249. **Printing Sets**.—The experiment of establishing a library printing press has been tried in at least one large American library, but the time does not seem ripe for a

similar enterprise in any British public library. To begin with, the cost of the necessary plant would prove prohibitive in all libraries with a limited income, and it is doubtful if there would be enough work, even in a large library, to justify the expense. A municipal printing press worked by direct labour is a more practical idea, which has been carried out, we believe, but a special library press is quite another matter. We question if even a small model printing press, with a limited outfit of type, would pay itself, even if the difficulty of obtaining the services of a sufficiently skilled man to work it could be overcome. For temporary purposes, however, we think a set of movable rubber printing types, with the requisite holders, etc., should be in possession of every library. They are very useful for printing all kinds of brief notices or intimations, and are a necessary adjunct to the ordinary fixed rubber stamps. A sign writer for printing notices in bold type, or classification and shelf labels, is also a useful addition to the minor appliances, and a medium set will be found extremely handy on many occasions.

250. Manifolding Apparatus.—The principal manifolding methods for manuscript work are the hektograph, cyclostyle, etc. For typewritten manifolding work the "mimeograph" is as good as any, though, generally speaking, there is considerable room for improvement in most manifolding methods associated with the typewriter.

DIVISION V.

BOOK SELECTION AND ACCESSION.

CHAPTER XVI.

BOOK SELECTION.

251. **General Principles.**—Although a great number of articles and papers have been written upon the subject of book selection, there still seems room for some remarks upon the general question from a standpoint somewhat different from the ordinary. Most of the articles which have come under our notice deal with the mere routine of book selection—how to systematise the ordering of books; the work connected with preparing them for public use; the bibliographical side; the question of duplicating popular books; and other more or less mechanical aspects of the matter. The philosophy of book selection, or questions connected with the policy of building up libraries, have rarely been considered.

252. The first point which occurs is the connection between a library's income and its book-purchasing power. As, by law established, most British library incomes are strictly limited, it follows that a similar limitation must govern the supply of books, and that only a *selection* of new books can be procured; old and out-of-print books taking their chance. The very largest rate-supported libraries are bound by this limitation to buy only a selection from the immense mass of books annually published, and, even if such purchases amount to several thousands of volumes, they only represent a *selection*. The smaller libraries must of necessity make a selection within a selection, and it follows that, in all cases of libraries supported

by very small incomes or burdened by heavy charges for the repayment of loans or other purposes, the selection must be very carefully made if it is to be thoroughly representative of all that is best in ancient and modern literature. Another factor which enters into the matter need only be mentioned in order to be dismissed: that is the obvious unsuitability of a very large proportion of the books annually published because of their form (pamphlets and tracts), subject-matter (school-books, bibles, etc.), or special nature (local lists, reissues, directories, etc.).

253. The fund available in most public libraries for the purchase of books can be made the basis for a rough calculation showing at what rate libraries of different sizes should grow. By reference to the table at Section 53 it will be found that the sum which can be annually expended on books is limited in libraries of all sizes, and that the annual additions must of necessity follow the same limitation. For the purposes of this calculation it is necessary to assume certain factors, and we shall accordingly adopt the book-storage capacity for different sizes of buildings given in Section 114. We must also assume that the annual book-fund is subject to a deduction of at least one-fourth on account of renewals of worn-out books, and that additions from the source of donation are an unreliable quantity. The stock of books when each library opens is also approximated; and the average cost of each book which we have adopted (3s. 4d.) may be taken as rather below the actual amount paid by libraries which select only good and valuable books. With these factors we can construct a table which shows what the possible normal growth of different sized libraries may be, and on it can base certain of our theories of book selection. But even these figures will be subject to considerable modification if the net-book system is extended more completely.

254. TABLE SHOWING THE POSSIBLE GROWTH OF LIBRARIES.

| Total Library Income. £ | Storage Capacity. Vols. | Annual New Book-Fund. £ | Annual Renewals. £ | Stock at Opening. Vols. | Annual Ad- ditions at 2s. 4d. per vol. | Grand Totals at End of Different Periods. | | | | |
|----------------------------------|-------------------------------|-------------------------------|--------------------------|-------------------------------|---|---|------------------|------------------|------------------|------------------|
| | | | | | | 10 yrs. Vols. | 20 yrs. Vols. | 30 yrs. Vols. | 40 yrs. Vols. | 50 yrs. Vols. |
| 100 | 5,000 | 8 | 2 | 800 | 48 | 1,280 | 1,760 | 2,240 | 2,720 | 3,200 |
| 500 | 20,000 | 38 | 12 | 3,000 | 228 | 5,280 | 7,560 | 9,840 | 12,120 | 14,400 |
| 1,000 | 34,000 | 75 | 25 | 6,000 | 450 | 10,500 | 15,000 | 19,500 | 24,000 | 28,500 |
| 2,000 | 68,000 | 225 | 75 | 10,000 | 1,850 | 23,500 | 37,000 | 50,500 | 64,000 | 77,500 |
| 3,000 | 102,000 | 375 | 125 | 15,000 | 2,250 | 37,500 | 60,000 | 82,500 | 105,000 | 127,500 |

255. The annual production of new publications in the United Kingdom may be taken at about 7,500 volumes, including everything, and the number of new books in this total may be averaged at about 5,800 volumes. It will thus be seen that the British municipal libraries must be *selectors* rather than *collectors* of books, because the income of no one of them is equal to buying more than a small proportion of the 5,800 new books published annually in Britain alone. Even by reducing the average price per volume, a rather dangerous procedure, the number would not be very greatly extended, because in any case the total additions could only be increased by two volumes per pound more, if the average price were taken at 2s. 6d. per volume, which is manifestly inadequate, especially with net books so greatly on the increase. But when other charges on the book-fund are reckoned, such as the cost of prints, maps, and American, French, German and other new books, it will be found that there is very little margin of any kind, and that our calculation is rather more favourable to the library than otherwise. Furthermore, it has to be remembered that every public library must from time to time acquire copies of standard books, or special works which are out of print, or unobtainable in suitable modern editions, so that the figures in our table may be accepted as reasonably accurate. This fact, and the presumption that the average cost per volume is, perhaps, too low, will counterbalance any increment likely to arise from the sources of donation and

an increasing library rate. Assuming then that the figures of the table are in the main fair, they rather bear out our contention in Chapter VII., that no library building need be overbuilt for the mere sake of providing a great amount of book-storage. This is a point on which we must again insist, as there cannot be the slightest doubt that most English public libraries, because of their accumulations of old, useless and effete books, are like huge gardens choked with weeds. The efficiency of many a library is clogged by the necessity for storing and caring for useless lumber, in the shape of books which are of no value or interest to any one. Their presence in a modern library is a serious hindrance to effective use and administration, because they occupy the space urgently wanted for more useful modern books; they add enormously to the cost of cataloguing and charging; and in many other ways they use up the resources of the library without in any degree adding to its public utility. Later on we shall consider this question both with regard to building up a library and judiciously pruning it.

256. It may be taken as a somewhat strong statement, but we make it without hesitation, that there are not more than 50,000 books, excluding duplicates of popular works and those in more than one volume, worthy of preservation in any public municipal library. The truth is that, of real, living works of literary and human interest, there are perhaps not more than 20,000 in the English language, but we prefer the larger figure in order to fully cover the world's literary output. Let any one who doubts this try and compile a list of even 5,000 books of permanent literary or other interest, in order to find what an awful task it is. No doubt the difficulty of selection is the main reason why public libraries are allowed to grow up in a haphazard way, because it is a work which demands not only persevering industry, but an encyclopædic knowledge of literature and the contents of books. Nevertheless, we regard this difficulty of selection, and the limitation of the field of selection, as powerful reasons why municipal libraries should completely abandon the museum or storage ideal, and go boldly

for making the workshop or practical utility ideal the one most worthy of realisation. In Chapter VII. we have already pointed out the great extent to which British libraries of all kinds have fostered the mania for indiscriminate collection, often at the expense of efficiency, while the workshop plan of library has been comparatively neglected. Even with unlimited resources, we doubt the wisdom of converting municipal libraries into huge rubbish heaps of the twaddle and exploded theories of the ages, especially when many special libraries are doing the work so much more effectively. Indeed, specialisation must be the watchword of the future, owing to the enormous literary activity of recent times, and the branch of specialisation which public libraries must adopt is careful *selection* of books and equally careful *rejection* of all which have outlived their day and purpose, or become "dull, stale and unprofitable". Public library buildings should be erected, not on the principle of storing as many books as can possibly be collected in fifty years' time, but of restricting the book accommodation to the reasonable limits which careful selection and cautious discarding will fix, and increasing the space available for readers, and giving them only the very best literature, imaginative or instructive, that the world has to offer.

257. It is a hazardous undertaking to lay down any particular rules for the formation of a British municipal library, and especially to state what proportions each class of literature should assume. Equally futile is it to take any figure as the average price which each volume in a library should cost. Although we have adopted 3s. 4d. as an average price, this must only be regarded as a mere basis for a calculation which simply aims at being a suggestion. Practically every public library differs in its needs according to its income and the special industries and character of the people in the town where it is situated.

258. Attempts have been made at various times by different authorities to lay down the proportions of every class of literature, and from these we have compiled a table which gives the average of the percentages given in the "A. L. A."

Catalog, Dana's Library Primer, reports of various libraries of all sizes and kinds, and the classified figures given in the *Publishers' Circular* from time to time of the annual output of books. We give these figures for what they are worth, and not by any means as a hard and fast guide to be followed.

PERCENTAGES OF CLASSES OF LITERATURE REPRESENTED IN
PUBLIC LIBRARIES, ETC.

| | | |
|---------------------------------------|----|--------------------------|
| Class A—Sciences | 8 | per cent of total stock. |
| „ B—Useful Arts | 7 | „ „ |
| „ C—Fine Arts | 7 | „ „ |
| „ D—Social Science | 8 | „ „ |
| „ E—Theology, etc. | 6 | „ „ |
| „ F—History and Travel | 15 | „ „ |
| „ G—Biography | 8 | „ „ |
| „ H—Language and Literature | 5 | „ „ |
| „ J—Poetry and Drama | 6 | „ „ |
| „ K—Prose Fiction | 20 | „ „ |
| „ L—Miscellaneous | 10 | „ „ |

There are one or two changes which modern practice will make probable in these percentages, such as increases in the percentages of classes B and C and a decrease in classes K and L. The attention now bestowed upon technical education and the universal provision of music texts will almost inevitably increase classes B and C, at the expense of some other classes, and K and L are the most likely classes, though F seems also somewhat unduly represented.

259. Imaginative literature rightly takes first place in the representation of classes, with 33 per cent., made up of Prose Fiction 20 per cent., Poetry 6 per cent., and Fine Arts (including Music, Painting, etc.) 7 per cent. Although Bacon in his classification of human knowledge places Imagination as represented by Poetry at the end of his scheme, thereby, perhaps, indicating his opinion of its comparative importance, there can be no doubt that as regards popularity, importance and longevity it easily maintains first place in the minds and hearts of a majority of the human race. Whose are the great

names in literature? The philosophers, or historians, or scientists? None of these. The story-teller, the song-writer, the singer and the artist completely overshadow all other kinds of literary and scientific genius, and monopolise a foremost position of honour among mankind, because, after all, they are the greatest teachers as well as the most capable entertainers. Homer, Dante, Shakespeare, Goethe, Cervantes, Molière, Balzac, Hugo, Scott, Dickens, Fielding, Thackeray, Burns, Byron, Milton, Beethoven, Handel, Wagner, Titian, Raphael, Turner, Rembrandt, and so on in endless variety, are infinitely greater and more treasured names to thousands of human beings than any of the exponents of more formal and exact knowledge. The story-teller and the singer will be remembered long after philosophies, and systems of history and science are as mouldering and forgotten as the ruins of ancient Babylon. The great majority of the people of all nations will much rather sing with the singers than chop logic with the philosophers, and this is at once a reason and justification for imaginative literature occupying the leading place in all public libraries. It has become the fashion for a certain section of librarians, a few public men and a considerable number of newspapers, to lament in doleful accents the popularity and preponderance of fiction reading in all kinds of lending libraries. But surely, Fiction, as the most hardy and flourishing form of literary endeavour, which has been built up by the contributions of some of the greatest minds of all nations, is not going to be denied its rightful place because certain narrow-minded persons think it fashionable to denounce the whole policy of public libraries? Whether they choose to do so or not matters very little, since it is quite evident that imaginative literature is going to survive, whatever happens, as it has done with extraordinary strength and vitality, through ages of change and destruction; while philosophical, political and social systems have appeared and disappeared in endless procession. We state all this as a reason why imaginative literature should occupy a foremost place in all public libraries, and because we think the theory of the survival of the fittest is

amply proved by the vitality of prose fiction, poetry and music, which entitles them to receive the attention due to their importance in the regard of mankind.

260. **Best Books.**—A live, up-to-date library, in addition to the literary classics in all departments, should only select the best and most popular books. The question of selecting only the very best, or only what is in great demand, should be compromised by always getting the best, with a selection of the most popular, subject to the understanding that the latter are to be discarded when their day is past. Every movement which stirs the public mind and imagination produces a great crop of books, but only a very small proportion of these survive, or are worthy of preservation. We do not argue against a moderate supply of such works at the time when public interest is aroused, but we object to the more ephemeral books of this kind being preserved long after all interest in their subjects has waned. If a municipal library founded in 1750, and steadily collecting for 150 years, could be found, its contents would be composed of enormous quantities of dead and forgotten theology, history, biography, science, fiction and every other class, which would not excite the slightest interest in the minds of five persons in a thousand. The skimmings of such a library would no doubt be valuable, and a fair proportion of it of interest and use to present-day readers, but the bulk of it would be of no practical service to any one.

261. The general public are comparatively indifferent to bibliographical rareties, and books which are merely curious or scarce should never be bought from the present restricted funds of British municipal libraries. There is a certain advantage in making a small special collection, on the museum plan, to trace and illustrate the evolution and history of printing and book production from the original manuscript forms, but the general collection of incunabula and rare specimens of typography by modern municipal libraries is a gigantic error, for which there is not the slightest excuse. There is infinitely more wisdom in spending £50 in a selection of modern works on technical subjects, which would be of immense service to

living persons, than in spending the same amount in the purchase of a single rare Bible which will only appeal to a few students of typography or the covetous feelings of rival private collectors. Books must not be regarded as an investment on which a profit can be made by a sale at some future date, because books of bibliographical rarity and much monetary value bought from public funds must remain as public property, inalienable for all time. The books bought for a public library should rather be regarded as machinery or plant, to be renewed when necessary and kept thoroughly abreast of the times.

262. Returning to the question of buying and preserving books of temporary interest. There are hundreds of subjects which in their day have excited great public interest, and in connection with which an enormous literature exists, but which have faded into comparative insignificance with the lapse of time. Take subjects like the Jacobite Rebellions, French Revolution, American Civil War, the Slavery controversy, Crimean War or Disruption of the Church of Scotland. Every one of these subjects was represented in its day by cart-loads of books and pamphlets, but the whole of these have been sifted and epitomised by later historians in works of permanent value, and municipal libraries can simply buy these, and leave the preservation of the contemporary literature, which ranks as original authorities, to the care of the special libraries which exist for the purpose. The literature of the Boer War is a case in point. It is necessary for public libraries while public interest is keen to select the best, or what may seem best, from the mass of stuff pouring from the press, but presently all this will be boiled down into three or four classics, giving in a comprehensive and sufficient manner every fact of the slightest interest to posterity, and then all the ephemeral works can be discarded in their favour. What remains of any particular interest to students, or even ordinary readers, from the huge literature which arose from the Crimean War? Only Kinglake and perhaps two popular illustrated books. The same holds good with all subjects which have created immense contemporary literatures, and there need not be the slightest compunction about discard-

ing any book when its usefulness is past unless it takes rank as a valuable original authority. At a later stage we give some suggestions on book discarding or library weeding which may prove helpful.

263. Book selection should be conducted upon the sound principle of buying only the best representative works on all subjects, whatever may be their cost or place of origin. We say this because what appear to be very mistaken views are published in an American *Library Primer*, which may influence young librarians in a disastrous fashion. It advises thus: "Buy largely books costing from 50 cents. (2s.) to \$2 (8s. 6d.), found in so many of the series now published. These are fresh, up-to-date, written for the most part by competent men, and are reliable." A more haphazard and ineffectual method of building up a public library can hardly be imagined. It is almost equivalent to advising a committee to buy cheap books by the yard in order to fill the shelves, and let the proper representation of great subjects depend on chance. Books published in "series" or "libraries" are too often mere commercial ventures, got up to sell by people who have nothing particular to say; and in the case of editions of standard authors, such uniform series are often the very worst form in which a poet or novelist can be presented to a reader. They are full of errors and omissions, and whether the series is devoted to art, science, literature or history, it may be taken for granted that they are simply temporary text-books which possess the doubtful advantage of being bound uniformly, and the undoubted disadvantage of being often uniformly erroneous and misleading. Of course this statement does not apply all round, because there are several well-known series of works of quite exceptional value. Connected with this a word may be permitted on the nationality of text-books. Patriotism in literature and library management may be a very fine thing, but it must occasionally lead to very sorry results in a public library. The same *Library Primer*, already quoted, advises that "Books on zoology, geology and botany should be by American in preference to foreign authors". No reason is given for this extraordinary advice, and we are

curious to know if this is simply patriotism carried to its extreme point, or if it represents something more practical, as, for instance, the probability of American text-books of this kind giving more prominence to the national fauna and flora. We should advise British librarians to buy the best and most recent scientific works, whether on biology, geology or any other subject, without regard to the nationality of the authors. We can see no objection to a book on botanical science written by a Hottentot, provided it is the *best* of its class, while we do see very considerable danger in text-books of a mediocre quality which are bought simply because their authors happen to be Americans or British.

264. Popular Books.—The duplication of popular or temporarily popular books is a policy to be adopted with the greatest of care. In some libraries the plan of multiplying copies of every book which becomes fashionable is carried to such an extreme that some injury must be done to the general work of the library by unduly fostering one class of literature at the expense of all the other classes. The practice of adding six copies of this new novel and six copies of that, must have the effect of decreasing the funds available for the purpose of buying different works on the same or various subjects of importance, and it certainly gives rise to misleading conceptions of the stock of books possessed by the libraries. A reported stock of 5,000 novels may easily mean an actual stock of only 3,000 different works to choose from in libraries which buy three, six or twelve copies of a single popular work. This makes a vast difference in the field of choice offered to borrowers, because, after all, popular novels of the ordinary boomed class, such as are manufactured in America to sell to drapers, etc., by the thousand, soon have their little day, and the duplicate copies become absolutely dead stock. For this reason we advise caution in the supply of extra copies of temporarily popular books, and the provision of a special stock or accessions book in which they can be registered and, when necessary, from which they can be written off without complicating the other records of the library. These remarks apply almost exclusively to the dupli-

cation of novels and magazines. There is less need to trouble about other classes.

265. **Replacements and Out-of-Print Books.**—Replacement of worn-out books is a serious matter in most libraries, but in English municipal libraries it assumes undue importance owing to the rate limitation, which makes this necessary provision a drain upon the fund available for new books. Before replacing an old or dirty book it should be carefully considered if it is worth retaining in the library. Closely connected with the question of replacements is the matter of out-of-print books.

266. “Most librarians in libraries of several years’ standing must have been confronted with the difficulty of obtaining copies of certain books which have been allowed to go out of print by their publishers. The number of such books is rapidly increasing, and among them are works which have taken a recognised place in English literature, as well as many others which have obtained a permanent value by being enshrined in the catalogues of hundreds of public and other libraries. In course of time many of these books are worn out, and it becomes necessary to replace them with new copies. It is then the discovery is made that fresh copies cannot be obtained, and the librarian is filled with dismay on receiving a long list of books from his bookseller marked with the ominous sign ‘O/P’. Time after time this experience is repeated, till the librarian begins to wonder if any of his catalogue entries of certain authors will stand good. A temporary relief is sometimes obtained by advertising for second-hand copies, but even these are becoming more difficult to procure, and in the case of novelists like G. P. R. James, James Grant and Harrison Ainsworth, only three-volume editions are reported. It is, therefore, quite evident that the time has arrived for some combined effort to be made by the librarians of the country, if their shelves are to be kept in agreement with their catalogues.

“We are not proposing that all out-of-print books which have figured in public library catalogues should be reprinted, but that every popular and good book which has been allowed to drop should be republished in a suitable form. There are hundreds

of good books which are mentioned in every history of English literature, which are quoted by speakers and newspapers, which appear in library catalogues, and which people are led to ask for because of such references, which are no longer to be had in any modern edition. There are other books which have obtained a certain measure of recognition and wide popularity, which, for some unknown reason, have been allowed to disappear from the lists of their publishers. Apart from the desirability of having copies of such books in public libraries in order to keep catalogues and stock books complete and correct, the further and greater question remains of keeping such books in print because of their place in English literature. In the case of some of the older books which form landmarks in literary history, it will be absolutely necessary to have well-edited modern reprints for the benefit of the students who are being formed in every school in the kingdom. In this case no question of copyright can intervene, and we have a strong feeling that the owners of copyrights which are no longer kept effective and alive by continuous publication should be deprived of the right of a monopoly which they decline to exercise. If a patent right becomes void by disuse, so also should the copyright in books. However, this is by the way, and scarcely affects the case, since it is more than likely the owner of a copyright would soon reissue an edition if he thought it worth doing. This is really the practical point of the whole question.

“The first question that a publisher will ask himself is this: ‘Will it pay me to reissue an edition of so-and-so, and, if issued, who will buy it?’ The answer to this is easy. If any book was once popular enough to find its way into most of the public and other libraries of Britain and her colonies, not to speak of the United States, it stands to reason that these institutions among them would be able to take up most of an edition of 1,000 copies at once, and with their replacements, as copies got worn out, gradually account for a considerable number more. If publishers of such reissues would print the books in a good style on a superior quality of paper, and issue them generally in a worthy form, there would also be a considerable demand for them

among booksellers and the general public, so that, altogether, the publisher would not be venturing so much on a wild-cat speculation as upon an absolute certainty. If a general understanding could be arrived at, that a certain number of the libraries of the country would purchase so many copies of the books as issued, there would be very little difficulty about getting a publisher or publishers to undertake the issue of public library editions, which would be creditable to all concerned. The question is a pressing one, and will become more and more urgent as time goes on."¹

Books which are purchased to replace worn-out copies should not receive new numbers, but should be given the numbers of the books which they replace.

267. Doubtful Books.—Censorship on books admitted into public libraries has been exercised much more frequently and rigorously in the United States than in the United Kingdom. Instances are common in both countries of books being excluded for sectarian or political reasons by Public Library Committees, but it has been reserved for a certain feminine committee in Boston, U.S., to carry the policy of excommunicating modern novels to such extravagant lengths as to merit the ridicule of practically the entire American literary press. These ladies have not contented themselves with sitting in judgment on novels suspected to have a strain of immoral teaching running through them, but have constituted themselves critics of literary style, with the result that several perfectly harmless and pleasant books have been condemned, because they did not reach the unknown standard fixed by these New England critics. This action is, in our opinion, utterly uncalled for on the part of any Public Library Committee. Their function is to protect the junior readers from coming into contact with demoralising literature, and to prevent the library from becoming a dumping ground for feeble and trashy books of all kinds, not to sit as the arbiters of public taste in composition and grammar to a ridiculous extent. No doubt the same enlightened ladies, who barred the works of certain generally accepted novelists,

¹ From an article by the author in *The Library World*.

would not hesitate to admit yards of colourless and inaccurate text-books of science, etc., such as are commented upon in Section 263. We do not object to a committee electing to sit in judgment on any book which may be thought to endanger public decency, or inculcate ideas of morality counter to those generally adopted, but we protest strongly against such explorations in search of the improper being confined to fiction. The question of buying certain *free* classics like Rabelais, Boccaccio, is quite another matter. All libraries ought to possess them, provided reasonable means are taken to prevent them falling into the hands of the immature reader. As regards what constitutes maturity, every library authority will doubtless frame its own rules.

268. Reference and Lending Books.—A difficulty is sometimes experienced in deciding for which department books of a certain class are most suitable. About such works as encyclopædias, dictionaries, annuals, directories, atlases, large art works, etc., there can be very little doubt, but expensive scientific books, large works of travel, theological and historical works of a certain kind offer a problem much more complicated. As reference libraries are at present constituted and used in many English towns, the plan of putting all expensive books of whatever nature in the reference department simply means that they are seldom used, and may as well not have been bought. In properly conducted open-access reference libraries, which are liberally and intelligently conducted, a good deal may be said in favour of placing such books there. They will at least be freely accessible without the formality of readers having to make written application, while the advantage of a reference book being always on the premises is not to be overlooked. We can see no harm in placing all kinds of expensive text-books in the lending department, and we counsel this action. If they are not issued they are always available for the use of any reference reader who wants them. The advantage to a student of being able to take a recondite and expensive text-book home with him for comparison with, and as an aid to, his own books is undeniable, and it is the fact that, by co-operation, the citizens of a

town can thus procure otherwise unattainable books, which makes the Public Libraries Acts so valuable, and adds force to the plea for placing expensive works within easy reach of the majority of readers. Local circumstances will in most cases modify the conditions under which reference and lending libraries are built up and differentiated. In some places there is no separation, save in the catalogue, between the reference and lending libraries, and in others both departments are not only kept apart, but subdivided into open, special and store collections. All this is very much a matter of administration to be settled by each responsible officer in accordance with his or her knowledge of the particular local conditions.

269. Local Collections.—It is hardly necessary to point out the very great importance of every public library commencing forthwith the formation of a collection of local books and other printed matter. It is difficult to make any distinction between what should be collected and what passed over. Our advice is to collect everything local, and let posterity decide what is worth retaining. The following suggestions may prove useful to inexperienced committees in doubt as to what is meant by a local collection. A local collection should contain:—

1. Every book, pamphlet or manuscript referring to the town or district.
2. Every print, drawing, map, plan (including those connected with land sales), or other similar publication or original copy.
3. Every book or pamphlet printed locally.
4. Books by authors who are natives of the town or district, and biographical notices and portraits.
5. Every newspaper or magazine or other serial produced in the district.
6. Photographs of every notable building, street, person or event in the district. [These may often be secured through the friendly co-operation of the local photographic societies.]
7. Election and other bills and posters, play-bills, concert programmes and other similar advertisements of local events.
8. All local records, or copies of them, such as registers, minutes and other MS. or printed records of the local authorities. [This is a very important matter, which ought to be settled definitely by Parliament. All local records should be accessible to the public, under proper safeguards, and the public libraries are the best centres in which to store and exhibit such records.]

It is better to let the local collection grow naturally than to attempt to force it into prominence all at once, unless some private collector's treasures can be acquired by gift or purchase with which to make a start. No local collection should be fostered at the expense of the general work of the library. Some librarians with antiquarian tastes occasionally do this, in districts rich in historical and archæological associations, to the undoubted prejudice of the efficiency of the general library.

270. Special Collections.—Most public libraries possess some kind of special collection in addition to the purely local collection. Examples of these may be specified in the Shakespeare and Cervantes collections at Birmingham; the Burns and Scottish poetry collections at Glasgow; music, shorthand, Chinese books, etc., at Manchester; fishes at Cheltenham; Welsh literature at Cardiff, etc. The literature of special local industries should always be collected, and there are good examples of such special libraries at Wigan (mining), Nottingham (lace and hosiery), Shoreditch (furniture), Clerkenwell (art metal-work, watchmaking), Rochdale (wool), etc. Works in foreign languages, particularly French, German and Italian, should also be collected, in addition to the Greek and Latin classics.

271. Sets of Magazines.—At one time it was considered a good thing to collect the principal magazines indexed in Poole's *Index to Periodical Literature*, but there is now much less enthusiasm on this point. When all is said in favour of magazine literature that can be said, the fact still remains that the interest in special articles is very short-lived, and only extends to about 5 per cent. of the contents of ordinary general magazines. Again, the best contributions to magazines are generally collected and published in a separate form, and so become procurable in a much handier form. The bulk of the contents of the ordinary magazines are articles on current matters of ephemeral interest, which do not endure more than a few years. For these and other reasons it is not advisable for any public library to meet the cost of collecting, binding and storing long sets of periodicals which are very seldom consulted. As regards

scientific literature, an elaborate special index is being prepared by the Royal Society, which will make the contents of British and foreign periodical literature fully available. Any public library existing on a limited income which deliberately proceeds to buy all the old magazines like the *Gentleman's*, *Edinburgh*, *Blackwood*, *European*, *Quarterly*, etc., for the mere sake of having them on the shelves, does a great injury to its supporters by thus wasting money in the provision of dead stock. The money could be much more profitably expended on the latest technical, historical and scientific works of current interest. The same may be said of Hansard's *Parliamentary Debates* and other stock sets, without which some librarians imagine their libraries would be incomplete.

272. **Music.**—Nearly every public library of any importance has now established a music collection, and the general experience is that it is one of the most popular and appreciated sections in the library. The provision should not at first extend to more than collections of pianoforte, violin, organ and vocal music in the form of bound volumes; operas, oratorios, cantatas and other vocal scores; the scores of orchestral and chamber compositions; and text-books on theory, history and various instruments. Single compositions in sheet form should be very sparingly introduced, if at all, unless collections of the songs of some of the best modern composers are formed and bound up into volumes. A large stock of compositions in single sheets, however bound or secured, would prove a great nuisance in a public library. The compositions of local composers should be collected, however, and bound in volumes.

273. **Engravings.**—Save in book form, we are not aware that many public libraries have done much in the way of collecting engravings, prints and etchings, unless they have been of local interest. Considerations of expense would deter most British public libraries from attempting this kind of collection, and it is rather a pity, because many prints and engravings which illustrate historical events have immense practical value. Portraits, too, are extremely valuable and useful, but as means are at present provided, the whole matter

is one of pure speculation and sentiment. But, perhaps, the day will come when public libraries may be able to collect specimens of the etched work of great artists; engravings after the greatest masters; engravings and prints depicting leading events in the national history; and pictures illustrating costume, ceremonials, manners and customs, disappearing buildings, great engineering works, topographical changes, etc. The value of these graphic aids to the furtherance of knowledge is enormous, and it is a pity some systematic effort cannot be made to record, preserve and index them more generally and effectively than has been done in depositories like the British Museum.

274. Photographs.—Collections of photographs which deal with local matters should be made by every public library, as recommended in Section 269. Certain American libraries also collect photographs of great pictures and those which represent various natural forms. Studies for the use of artists are also collected, mounted on cards, and made accessible, and some of these attempts to popularise art should be made in British libraries. Photographs are comparatively cheap, and almost every kind of picture and study can be obtained in this medium. What is particularly required is some kind of practical list or guide, drawn up by an expert, from which libraries could make their selections. A systematic list covering the various arts of design, historical painting, sculpture, architecture, etc., would be of great service. Photographs of great public events, ceremonials, buildings, etc., and of eminent personages, would have to be purchased according to means, and, as every one knows, this might be made an endless matter. We do not see, however, why public libraries should not preserve good photographs of the most eminent authors, artists, musicians, scientists, military commanders, royal personages, etc. Portraits of such persons are not always easy to find in books, when required, especially as no general portrait-index exists to aid the search; therefore a separate collection of portraits in alphabetical order would be a valuable addition to a public library.

275. Books for the Blind.—Many libraries now store and circulate books for the blind in the Braille and Moon types, and in this work some of them have been aided by the expert advice and actual donations of special societies interested in the well-being of the blind. There is quite an extensive and rapidly growing literature for the blind in the special raised type required for finger-reading, and a library of a few hundreds of volumes makes quite an imposing show. The question of space will arise in many places, because books for the blind can only be embossed on one side of each page, and, owing to this embossing and the size of the type, some books make several thick quarto volumes. No space could, however, be devoted to a more humane or valuable purpose than the storage of books for the blind, and every encouragement and support should be given to the movement; though it would undoubtedly be the most effective method of ministering to the needs of the locality to subscribe for a constantly changing supply of books to one of the institutions for the blind which make a speciality of this kind of work.

276. Maps.—In addition to all local maps and plans, old and new, sets of the Ordnance and Geological Survey maps on the one-inch scale should be added. Atlases will exist in the reference library as a matter of course, but maps of the United Kingdom suitable for tourists, cyclists, anglers, climbers, etc., should be added as freely as possible.

277. Discarding Effete Books.—The question of periodically weeding out a public library, with the object of keeping it always up-to-date and also making room for fresh additional stock, has already been partly discussed in Sections 110-112 and 251-264. It is a most important part of modern public library policy, which will require to receive much greater attention in the future than it has in the past. As pointed out in Chapter XXII., the periodical reprinting of class lists affords a valuable opportunity for considering the claims of certain kinds of books to remain idle on the shelves, where they not only fill the space which should be available for more alive works, but they obstruct the general work of the library.

Every public library receives at one time or another books which must for reasons of policy be catalogued. Such books, for example, as are donated, are expected to be placed in the library and duly catalogued. There are generally hundreds of such books in every large library, which have been received from donors who are 'cute enough to recognise that a certain amount of *kudos* attaches to a public-spirited citizen who gives books to a library, while they take care that only the lumber and rubbish of their own collections are presented. It is very rarely that the average public library receives anything more valuable than the sweepings of some private collection, or literature sent free by political, sectarian and commercial coteries. Gifts of modern scientific books, or works of travel, or batches of the best current fiction are just the kind that are seldom or never made. But piles of unbound and ragged periodicals, old guide-books, calf-bound theology of the eighteenth century, prayer-books, and useless lumber of the same sort seem to exist in untold quantities, and are the usual donations thought suitable for public libraries. From this source, and also the mistaken selections of committees and librarians, come a large number of books which are of very little use, and these should be discarded as soon as decency permits. There are also, of course, the books which go out of use automatically, such as those noted in the subjoined RULES, and those others which manage to slip into libraries in those sleepy moments when the custodian is dreaming of higher things, or is misled by the erroneous titles adopted by authors. We do not advocate an annual process of weeding out libraries, but there are occasions, such as when the catalogues are being reprinted, the books are being rearranged, or any kind of fresh movement is being made, when the opportunity should be seized to judiciously prune the luxuriant growth of weeds which will somehow manage to infest the best-regulated libraries in spite of every care. The sentimental museum idea is, of course, responsible for much of the tendency to collect and preserve everything, on the Byronic theory, no doubt, that

A book's a book, although there's nothing in't,

and, as a library is a repository for books, then *all* books should be collected and preserved at any hazard or sacrifice, be they good or bad.

278. RULES FOR DISCARDING USELESS BOOKS :—

CLASS A—SCIENCE.—All general works which are not epoch making, but merely recapitulations of ascertained facts, should be discarded when twenty years old. Care should be taken not to discard any book, however old, which has not been efficiently superseded. All ordinary text-books of every science, save mathematics and occult science, may be discarded when twenty years old. Nicely illustrated text-books, especially of zoology and botany, should be discarded with much caution.

CLASS B—USEFUL ARTS.—The same rules apply to this class as to Class A, save that patents, specifications, recipes, books on household arts, and all finely illustrated books should be retained.

CLASS C—FINE ARTS.—Books must be discarded very sparingly in this section. Collections of engravings, finely illustrated books, and collected music, not at all.

CLASS D—SOCIAL SCIENCE.—This class requires frequent revision, especially in the sections devoted to political economy, government, law and education. Books on questions of momentary interest can be replaced by historical résumés. Constantly changing subjects like law, government and political economy should be kept up-to-date as much as possible, and the historical record kept by means of recent histories. Questions like parliamentary reform, slavery and chartism are illustrations of once burning topics which may just as well be represented by a few modern histories as by actual collections of the very voluminous literature attached to each subject.

CLASS E—THEOLOGY AND PHILOSOPHY.—Philosophical works, particularly systems of philosophy, should never be discarded. Historical and explanatory text-books may be discarded as they become superseded by later works. Old theology, commentaries on the Bible, sectarian literature

and sermons should be discarded very freely. Theological controversies should never be collected by general municipal libraries unless of local interest.

CLASS F—HISTORY AND GEOGRAPHY.—Historical works which are mere résumés, and not themselves original authorities, may be discarded with comparative safety; but the matter of illustrations again applies here with considerable force. Works of travel of the ordinary globe-trotting description may be discarded when ten years old, along with all kinds of guide-books, save those which are local. But here, again, beware of discarding illustrated books. Pioneer works of exploration should be retained. Old gazetteers are, as a rule, lumber, but some of the illustrated ones, like Lewis' for Britain, may be retained for their armorial illustrations. Histories which are literary classics, like Hume, Robertson, Clarendon, should be kept, even if superseded by more accurate modern works.

CLASS G—BIOGRAPHY.—Collected biography should never be discarded. The biographies of nonentities in the individual biography class may, however, be weeded pretty freely and frequently after they are from forty to fifty years old.

CLASS H—LANGUAGE AND LITERATURE.—Old grammars may be discarded without risk, and also ordinary school dictionaries. Books on literary history, bibliography and librarianship are tools and should never be discarded.

CLASS J—POETRY AND DRAMA.—Collective works should never be discarded unless efficiently superseded. But poets and dramatists of a day who are no longer read may be safely discarded, but no one who is named in the history of literature.

CLASS K—PROSE FICTION.—Novelists mentioned in literary histories should never be discarded. Minor novelists of all kinds, who are not mentioned in literary histories, whose works have remained unissued for a year or two, should be promptly discarded. So, also, should mere catch-penny topical novels of no permanent interest, which libraries are often forced to buy under pressure. A con-

tinuous popularity is a good reason for retaining any novel, provided it is not immoral.

CLASS L—MISCELLANEOUS.—Discard old encyclopædias with care; newspapers or directories freely. Retain all local matter of this kind however. Be extremely chary about storing inferior magazines of the miscellany order. A long set of an old magazine of this kind is a positive incubus, and most modern magazines of the snippet order are not worth houseroom. Wear them out in the reading rooms by all means, but do not preserve them.

279. None of the foregoing recommendations for discarding apply to bibliographical rareties or curiosities; to works of recognised literary merit which are mentioned in histories of literature; to books which are of local interest; or to special collections. They apply simply and solely to the rank and file of literature, the 50 per cent. of the fruits of the press which become stale through effluxion of time. The question of how to dispose of discarded books can generally be decided by some local circumstance. Discarded text-books of science are generally of little value to any one, and need not be preserved at all. But faded works of travel, history and biography may find interested readers in workhouses, hospitals and prisons. To these, or similar institutions, the discarded books of a public library could be transferred. It is hardly necessary to point out that books which are not good enough or fresh enough for a central library, are not good enough for a branch library. Books proposed to be permanently withdrawn should be submitted to the library committee, and lists of the discarded books should be printed in the bulletin, if there is one, or, failing that, in a separate form. It is only right that all readers likely to be interested should be afforded an opportunity of judging the proposals and action of the library committee in its work of weeding out the library. Any serious objection to a book being removed should be duly considered, and nothing should be done without the utmost deliberation, because, as yet, we have not achieved a public library *index expurgatorius* of books not worth preserving. When this comes, the task will be immensely

lightened. No books which are discarded should be permitted to leave the library unless stamped, to indicate that they are rejected. A stamp with a movable dating centre should be used, with the words, " Public Library, Discarded," in a circle.

280. Practical Methods of Selection.—The number of books which have been published to aid in book selection is somewhat large, but very few of them, save, perhaps, Sonnenschein's publications, make any attempt to indicate the best editions of particular authors. It may be assumed that every entry in these lists of best books represents a work which is recommended on account of its merit, literary or otherwise. But something more than this is required by the librarian who is faced with the task of building up a great modern library, and is limited in his selection to books of the most enduring merit, and those which most completely and accurately record the state of the science or subject to which they are devoted. It is a very easy matter to simply order *books*, like the millionaire who fitted up his library by the superficial yard, thereby tempting a bookseller, entrusted with a large order for books of a uniform size in fine bindings, to bind up some hundreds of copies of a cheap "remainder," in different covers, but with varying titles, in order to provide in dummy form the necessary mileage of books required. Public library formation can hardly be undertaken in this happy-go-lucky manner.

281. The principal aids to the selection of new books are journals of various kinds, which review and advertise them as published. Comparatively few of the literary journals review books in a manner helpful to the would-be book-buyer, because they do not describe the contents of them so much as criticise their literary style, production, printers' errors, etc. Generally speaking, a modern book review is what it was in the old days of the *Edinburgh* and *Quarterly*, simply a peg on which to hang the reviewer's opinions on the subject of the book, and on which to display his knowledge and critical insight. The subject of the book, its style of treatment, scope, and details of its contents are left to be divined by the reader. Some of

the modern publishers' monthly catalogues are much more helpful than any journal or review, because they add brief descriptive notes to each entry of a new book. A plain, practical note outlining the principal contents and intention of a book is worth pages of critical remarks to the librarian book-buyer. The following is a list of the journals most used by librarians in selecting new books:—

GENERAL:—

| | | |
|------------------------------------|---|--|
| Academy | } | All weekly, and most of them giving a summary list of new books, reviews and advertisements. |
| Athenæum | | |
| Literary World | | |
| Publishers' Circular | | |
| Saturday Review | | |
| Speaker | | |
| Spectator | | |
| Bookman (gives brief annotations). | | |
| Bookseller. | | |
| Nation (New York). | | |
| Publishers' Weekly (New York). | | |
| Times Literary Supplement. | | |

SPECIAL:—

| | | |
|--------------------------------------|---|---|
| Nature (scientific books generally). | | |
| Magazine of Art (art books). | | |
| English Mechanic (technical books). | | |
| Engineer | ” | ” |

In addition to the very uncertain and unsatisfactory method of thus choosing new books by their titles, because it amounts to very little else, some arrangement is required whereby libraries can obtain non-fictional books on view, so that they can be properly examined before being ordered.

282. The best guides to the titles of old books, which, of course, include modern books other than recent publications, will be found in the undernoted list. Here again, no doubt owing to the largeness of the field, notes in aid of choice are badly wanted. Sonnenschein's books are the best in this respect, if we except the special annotated lists:—

283. GUIDES:—

- Acland (A. H. D.) Guide to the choice of books. London. 1891.
 Catalog of "A. L. A." Library. 5,000 volumes for a popular library, selected by the American Library Association. Washington. 1898.
 Hewins (C. M.) Books for boys and girls. Boston. 1897.
 Leyppoldt and Iles. List of books for girls and women, and their clubs. Boston. 1898.
 Perkins (F. B.) The best reading: hints on the selection of books. Boston. 1872-1886. 2 vols.
 Sargant and Wishaw. Guide-book to books. Oxford. 1891.
 Sonnenschein (W. S.) The best books: a reader's guide . . . to 1890. London.
 — Reader's guide to contemporary literature (Supplement to above). London. 1894.

BIBLIOGRAPHIES AND PUBLISHERS' LISTS.

- Allibone and Kirk. Critical dictionary of English literature. Philadelphia. 1858-1891. 5 vols.
 Lowndes (W. T.) Bibliographer's manual of English literature. London. 1854-1864. 6 vols.
 Stein (H.) Manuel de bibliographie générale. Paris. 1897.
 Reference catalogue of current literature. Published every few years by Whitaker, London.
 English Catalogue. Published annually by Low & Co., London.

284. SPECIAL SUBJECTS:—

- Adams (C. K.) Manual of historical literature. London. 1894.
 Baker (E. A.) Guide to the best fiction. London. 1908.
 Brown (J. D.) English prose fiction. (In preparation.)
 — Guide to the formation of a music library. London (Library Association). Supplemented by a list in "The Library World". Vol. 1, pp. 227, 256.
 Gross (C.) Sources and literature of English history to 1485. London. 1900.
 Haferkorn (H. E.) Handy lists of technical literature. 1889-1891. *Various parts.*
 — Handy list of books on fine arts and architecture. 1898.
 Kroeger (A. B.) Guide to reference books. . . . Boston. 1902.
 Mayor (J. B.) Guide to the choice of classical books. London. 1879-1896. 2 vols.
 Mill (H. R.) Hints . . . on the choice of geographical books. . . . London. 1897.
 Sturgis, Krehbiel and Iles. Annotated bibliography of fine art. Boston. 1897.
See also the list at Section 87.

285. REFERENCE LIST OF AUTHORITIES:—

GENERAL.

- Aldred, Thos. Book selection and rejection. L. A. R., v. 8, p. 148.
 Andrews, E. P. Book selection. Lib. J., 1897, Conf. no., p. 70.
 Baker, E. A. Wanted—A guide-book to books. L. A. R., v. 2, p. 89.
 Book selection and annotation. L. W., v. 3, p. 87.
 Brown, J. D. Select lists of books on important subjects. L., v. 7, p. 368.
 Burgoyne, F. J. Choice of books for small libraries. (With list of bibliographies, etc.) L. A. R., v. 3, p. 189.
 — Selection and purchase of books. L. W., 1899, pp. 186, 157.
 Cutler, M. S. Principles of selection of books. Lib. J., 1895, p. 389.
 Cutter, C. A. Should libraries buy only the best books or the best books that people will read? Lib. J., 1901, p. 70.
 Dana, J. C. Book selection. See his "Library Primer," pp. 39-52.
 Fletcher, W. I. Selection and purchase of books. See his "Public libraries in America," p. 68.
 Larned, J. N. Selection of books for a public library. Lib. J., 1895, p. 270.
 Selection of books. Symposium by American librarians. Lib. J., 1894, Conf. no., pp. 24, 34, etc.

REPLACEMENTS.

- Steiner and Ranck. Replacements. Lib. J., 1896, p. 397.

DOUBTFUL BOOKS.

- Improper books: methods employed to discover and exclude them. Symposium by American librarians. Lib. J., 1895, Conf. no., pp. 32, 36.
 A nocturnal conclave. L. W., v. 2, 1900, p. 285.

REFERENCE BOOKS.

- Barrett, F. T. Selection of books for a reference library. L., v. 8, p. 473.
 Borrajo, E. M. Books for the reference library: some selected lists and a suggestion. (Specialist advice.) L. A. R., v. 3, p. 770.
 Dent, R. K. Formation of a small reference library. L., v. 8, p. 519.
 Richardson, E. C. Reference books. U.S. Educ. Rept., 1892-1893, v. 1, p. 976.
 Wood, B. Selection of books for a reference library. L., v. 8, p. 522.

LOCAL COLLECTIONS.

- Axon, E. Public records and public libraries. L. A. R., v. 2, p. 142.
 Ballinger, J. Photographic survey of counties. L., v. 3, p. 436.
 Doubleday, W. E. Local records and public libraries. L. A. R., v. 2, p. 181.
 Gould, I. C. Local records. L. W., v. 2, pp. 281, 257, 313.
 Plomer, H. R. Local records and public libraries. L., v. 4, p. 187.
 Shepherd, J. Topographical prints, etc., in public libraries. L., v. 8, p. 69.

SPECIAL COLLECTIONS.

- Baker, E. A. French fiction in public libraries. (With list.) L. W., 1899, pp. 68, 79.
- Guppy, H. French fiction and French juvenile literature for the public library. L. A. R., v. 2, p. 357.
- Mathews, E. R. N. Libraries and music. L., v. 5, p. 190.

FICTION.

- Brown, J. D. Fiction classification. (A skit.) L., v. 8, p. 22.
- Coe, E. M. Fiction. (With list of articles.) U.S. Educ. Rept., 1892-1893, v. 1, p. 933.
- Common novels in public libraries. Symposium by American librarians. Lib. J., 1894, Conf. no., pp. 14, 18, 23, etc. (On the desirability of stocking and circulating novels of no literary or special ability.)
- Fiction in libraries. Symposium by American librarians. Lib. J., 1890, pp. 261, 325. Lib. J., 1891, p. 8.
- Great fiction question. (Complete review of the whole matter.) Greenwood's Year Book, 1897, p. 107.
- Hosmer, J. K. In praise of the novel. L., N. S., v. 1, p. 132.
- Turner, F. In defence of fiction reading. L. W., 1899, p. 113.
- Woodruff, E. H. Fiction in public libraries. Lib. J., 1895, p. 342.

BOOKS FOR THE BLIND.

- Hartley, M. E. Reading for the blind. L. W., v. 2, p. 203.
- Utley, H. M. Books for the blind. Lib. J., 1898, Conf. no., p. 93.

MAPS.

- Baker, E. A. Maps in the lending department. L. W., 1896, p. 54.
- Ordnance maps. L. W., 1901, p. 144.
- Fletcher, R. S. Maps and charts in the public library. P. L., 1899, p. 444.
- Parsons, F. H. The care of maps. Lib. J., 1895, p. 199.

DISCARDING.

- Brown, J. D. Library progress. L., N. S., v. 1, p. 5.
- Clarke, A. Scientific text-books, and the disposal of editions out of date. L., v. 6, p. 164.
- Learned, W. The line of exclusion. (Selection of books.) Lib. J., 1896, p. 320.
- Richardson, E. C. Survival of the fittest among books. Lib. J., 1897, Conf. no., p. 45.
- Sifting as a library policy. Lib. J., 1898, p. 118.

For list of abbreviations see Section 88.

CHAPTER XVII.

ACCESSION METHODS.

286. **Donations.**—The first British Public Library Act did not make any provision for funds with which to buy books: it trusted entirely, with the innocence of extreme youth, to the benevolence of donors. As these somewhat rare persons did not respond in a very encouraging manner, the Acts were forthwith amended, and communities given power to purchase books from such limited funds as were left after loans, the librarian's salary and the gas bill had been settled. Although every library benefits now and again from the generosity of donors of books and money, we may safely aver that donations cannot be regarded as a reliable source from which to expect a constant and liberal supply of good and suitable books. Indeed, it may be confidently asserted that more rubbish, in the shape of worthless books and pamphlets, is bestowed annually on public libraries by donors, than anything of a useful or valuable sort. Touting for donations is to be avoided. It is not only undignified, but nearly always results in non-success and a certain loss of status to the library which employs a general begging policy.

State papers and public documents are carefully preserved in many libraries in the United Kingdom. Most of the best parliamentary papers and reports can be obtained free on application to H.M. Stationery Office in London, but other valuable public documents, like some of the Record Office publications, the Ordnance Survey, etc., must be purchased. The parliamentary papers were not given free to public libraries till after years of agitation dating from the time of Edwards in 1850. A selection of these papers will be found sufficient for most libraries, and this can be made from the lists published by H.M. Stationery Office.

287. All donations, whether good, bad or indifferent, should be duly recorded in a special DONATION BOOK, and the donors should be thanked in the usual manner, either by means of a special circular or post-card. For the majority of donations, a printed

post-card of acknowledgment will suffice. Specially valuable gifts must be acknowledged by special resolutions, and conveyed in much handsomer form. The usual wording for post-card acknowledgments runs thus :—

| |
|---|
| <p>LIBERTON PUBLIC LIBRARY.</p> <p>I am directed to acknowledge receipt of your donation named below, and to convey to you from the Library Committee the expression of their most cordial thanks.</p> <p style="text-align: right;">Yours faithfully,</p> <p style="text-align: right;">.....<i>Librarian.</i></p> <p>.....</p> |
|---|

FIG. 98.—Donation Acknowledgment (Section 287).

288. The following ruling of a donation book will be found to answer all ordinary purposes :—

| 9" | | | 9" | | | | | | |
|--------------|------------------|-------------------------|--------------------------|--------------|----------------------------|-------------------|------|----------|--|
| Donation No. | Date of Receipt. | Date of Acknowledgment. | Description of Donation. | No. of Vols. | Name and Address of Donor. | Accession Number. | | Remarks. | |
| | | | | | | Lend. | Ref. | | |
| | | | | | | | | 18" | |

FIG. 94.—Donation Book Ruling (Section 288).

The donation number is a progressive number which should be given to all gifts, particularly books, because, when pencilled on volumes which are duplicates or not stocked for any reason, it is easy to ascertain their history by turning up the number in the donation book. Most of the other headings explain themselves. When books are added to the library as donations it is well to carry into this record the accession numbers given to them in the columns provided. In the "Remarks" column can be entered any information as to the disposal of the gifts. In some libraries a book is used which resembles a receipt book in having a counterfoil and a tear-off sheet forming a thanks circular or acknowledgment form. This style of book is less satisfactory than the form of record given above.

289. **Propositions.**—There are comparatively few suggestions of new books made by readers in public libraries, most of the proposals coming from the librarian and the committee. It is customary to provide a book in which members of the public can enter their propositions, or slips, as described in Section 65. Slips are perhaps preferable to books, as they are more likely to be used and are handier to arrange. Failing them, an ordinary foolscap folio book can be provided, ruled with columns across two pages showing—

| Date of Proposal. | Author. | Title. | Date of Publ. | Vols. | Price. | Publisher. | Name and Address of Proposer. | Decision of Committee. |
|-------------------|---------|--------|---------------|-------|--------|------------|-------------------------------|------------------------|
| | | | | | | | | |

FIG. 95.—Proposition Book Ruling (Section 289).

290. From the suggestions of the public and the committee and his own study of reviews, catalogues, journals, etc., the librarian prepares a list of book propositions for the use of the committee, or special books sub-committee, as the case may be. This list may either be entered and kept in the proposition

book, or written out on separate slips (5 inches \times 2 inches), which can be afterwards used as catalogue copy for the printer. We prefer the latter plan as being most economical and convenient, especially when worked in conjunction with suggestion slips instead of a proposition book. When the list has passed the committee, with whatever modifications they may have imposed, the books can be ordered as described below in Section 292. These propositions are the main source from which the library is selected and built up, and ought to be prepared and examined with great care. Arising out of this part of the subject is the question of buying books at sales. This is often done through a bookseller or other agent, who receives a marked copy of the catalogue, with the prices to be offered written against each entry, and for his services in attending and bidding 5 to 10 per cent. is generally allowed. Of course, at any book-sale in the same town as the library, the librarian may attend, but an experienced agent is more likely to avoid mistakes. Unfortunately very few public libraries can afford to compete with the booksellers and private collectors in the saleroom, and practically this source of accessions is not of much use to the majority of British public libraries.

291. Subscription Books.—Sources of book supply in many libraries are the works coming regularly as annuals, or from societies to whose publications the library subscribes. Patents' specifications, parliamentary reports and other periodical publications also furnish a constant, if somewhat irregular, stream of additions. There should be some simple means of checking these annual and irregular publications, and a series of cards, somewhat similar to those suggested for magazines in Section 485, will be found very convenient. It is hardly necessary to add that these check-cards should be examined regularly every month for overdues and omissions. Societies which issue occasional monographs only are the most difficult to trace and check. With annual publications of a definite kind, such as *Whitaker's Almanack*, there is no trouble whatever.

292. Ordering.—The routine of book ordering should be reduced to the simplest possible system. There are plenty of elaborate methods designed to find out and penalise defaulting

assistants, booksellers, etc., but we do not recommend these. The very simplest plan is to place the proposition slips in a special tray when passed, in a compartment marked "Books passed by committee," and then to enter them in an ordinary order-sheet, stamping them with the date, to be copied later into an ordinary press copying order book. These order sheets (8 inches x 10 inches) may be ruled thus:—

| LIBERTON PUBLIC LIBRARY, | | | | | |
|--|--------|-------|------------|--------|----------|
| | | | | |190 |
| M.....will oblige by supplying the following books according to the terms of..... contract, as soon as possible, accompanied by an invoice setting out the price of every single book, and the discount. | | | | | |
| Author. | Title. | Date. | Publisher. | Price. | Remarks. |
| | | | | | |

FIG. 96.—Book-Order Sheet (Section 292).

In the "Remarks" column can be entered the date of receipt when a parcel of books is being marked off.

293. The slips aforesaid should be transferred to a compartment marked "Books on order," and as the books are supplied they can be withdrawn and placed in a compartment marked "Books for catalogue". This will leave a residue of overdue books, which can be overhauled every now and again, and transferred to a compartment marked "Books overdue," when written for. A simple form of tray is one divided by means of sliding blocks, with projecting guides to indicate the contents of each compartment (Fig. 97).

This plan of keeping check of books on order, at every stage, will be found much simpler, and more accurate and convenient than any system of book-keeping.

294. Accession Work.—When a parcel of new books arrives

from the bookseller, or a monthly lot of donations is passed, it is wise to enter each lot in a special book called the ROUTINE book, which will determine the order of numbering, and give rough figures of cost and number of additions to all departments. This book is ruled as shown on next page, and explains itself.

Each lot of new books should be carefully examined for imperfections, etc., before being numbered. They should next

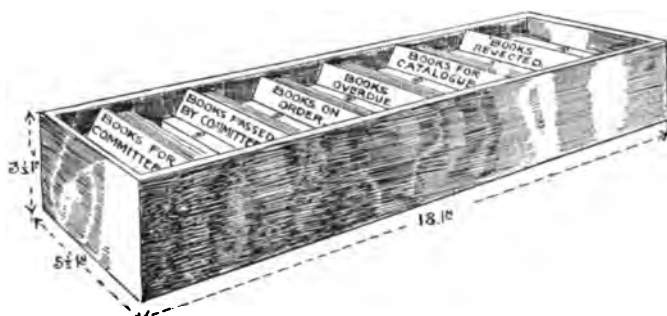

FIG. 97.—Book-Order Tray (Section 293).

be arranged in order of invoice or donation book, with the lending and reference books in separate lots.

295. The ACCESSION NUMBERS must next be applied, and it should be made a rule in every library, whatever method of classification is adopted, to give the books a progressive accession number irrespective of a class number. A special book for recording these numbers should be obtained, one each for the lending and reference libraries, ruled as follows:—

| Progressive No. | Class Letter. | Author and Title. | Class or Shelf No. |
|-----------------------|---------------|----------------------------|--------------------|
| 1 | A | Balfour. Manual of Botany. | 200 |
| 2 | | | |
| 3 | | | |
| 4 | | | |
| 5 | | | |
| and on to 50 per page | | | |

FIG. 99.—Accessions Number Book (Section 295).

| Date. | Source : Donor or Vendor. | First Word of Invoice. | Accession Number. | | Number of Vols. | | Cost. | | | Replacements. | | Remarks. | |
|--------|---------------------------------|------------------------------|----------------------|------|--------------------|------|-------|------|-------|---------------|-----|----------|-----|
| | | | Lend. | Ref. | Lend. | Ref. | Lend. | Ref. | Vols. | Cost. | | | |
| 1901. | | | | | | | | | | | | | |
| June 6 | Tompkins | Balfour | 1-50 | 1-25 | 50 | 25 | 7 | 10 | 0 | 6 | 0 | 19 | 0 |
| " 12 | Donations | See Book | 51-56 | ... | 6 | ... | ... | ... | ... | ... | ... | ... | ... |

Fig. 98.—Accessions Routine Book (Section 234).

This will show at a glance the next vacant number to be used, and also, roughly, the total number of books in the library at any given moment, when the withdrawals are counted off. The accession numbers should be written on the back of the title-page of each book, and should also be written against the entry on the invoice, and also, if a donation, into the appropriate column of the donation book.

296. According to the system of charging used, each book should be dealt with further, as regards appropriating its equivalent card, indicator book, or ledger page, as may be needful. Assuming that card charging is the adopted plan, a specially ruled manila book-card, as below, must be prepared, by having the accession and class number and letter, and its author and title written on its front surface :—

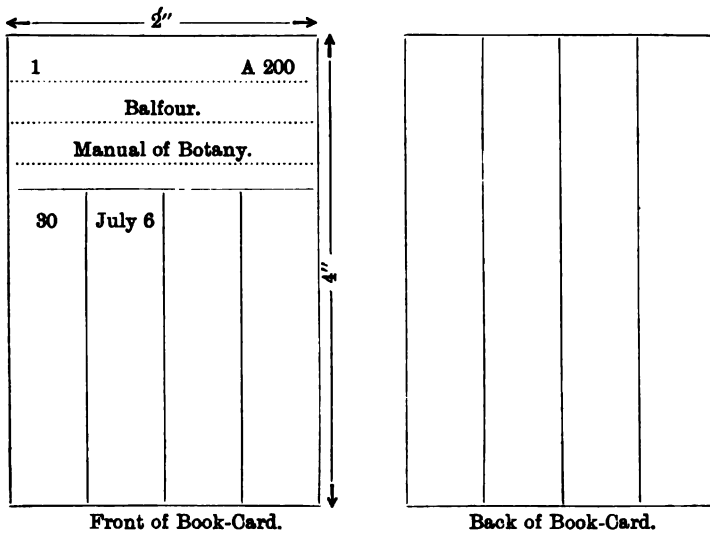

FIG. 100.—Book-Card (Section 296).

This form of book-card is ruled to take the borrowers' numbers and dates of issues, and is one of the main accessories of the card system described in Sections 444-445.

297. With indicators it is necessary to write the accession numbers on to the indicator books or tabs according to the

style of indicator used. In some forms, like the Elliot, the number is already fixed on the indicator frame and requires no additional book tab or block. Other processes connected with book numbering for shelving purposes are considered in Chapter XX.

298. The next process is the LABELLING of the books. Reference library books are usually labelled on the inside of their front boards with the library book plate, which may be an artistic device, or a simple label bearing the town's arms and a few of the chief rules appertaining to the department. Some libraries add a label ruled in columns to show dates of issue, but we do not recommend this method, although it is useful in libraries which do not grant open access, for showing unused books which might be discarded. Lending library books are labelled with a label pasted down on the inside front board bearing the chief rules applicable to borrowers, and with a date label secured to the front fly-leaf by means of a narrow line of paste on the inner edge. This enables the label to be easily removed when stamped all over with dates of issue. An ordinary form of date label is ruled in columns to take the dates as follows:—

| | | | | |
|--------------------------|--|--------------|--|--|
| No. 1. | | Class A 200. | | |
| LIBERTON PUBLIC LIBRARY. | | | | |
| | | | | |

FIG. 101.—Book-Issue Label (Section 298).

299. The **STAMPING** and **CUTTING UP** of new books is the next step in the preparation of books for public use, and as regards the latter it is necessary to insist that the leaves should be cut close into the backs of the books, and not left uncut to within half or quarter an inch of the back, so that an ugly tear is made whenever the book is fully opened. Librarians should teach their assistants that a half-cut book is an abomination not to be endured.

Various kinds of stamps are used, ink, embossing and perforating. The ink ones, usually applied with rubber dies, are not satisfactory when used with ordinary aniline endorsing inks, as they can be erased quite easily. Printers' ink is much more satisfactory, but it takes a long time to dry, and requires metal stamps to make it work easily. But for their expense embossing stamps are most satisfactory, and of the various kinds of these the perforating stamp formed like a pair of nippers is the easiest to apply. Whatever kind of stamp is used, it should be made in a circular shape, so that no time need be lost in applying it with care in order to secure evenness.

Every library should select certain fixed pages on which the stamps are to be placed, and, in addition, every title-page, first and last leaf, end-papers and all plates should be stamped. One order of stamping may be specified as follows: Front end-paper; title-page, back or front; beginning of text; top of page 20; bottom of page 100; top of page 120; and so on alternately; end of text; back end-paper; all plates, maps, etc. But every library will adopt its own fixed places for impressing its stamps.

300. **Stock Book.**—This is the chief inventory or record of the books contained in the library in every department, and should be ruled to show the history of each book from its accession till its final withdrawal. The intermediate renewals of worn-out copies need not be shown in this book, as they complicate the record immensely, and there seems no strong reason for doing more than noting the total number of renewals in the routine book, as already shown in Section 294. There are many forms of stock books, but for ordinary British municipal

libraries the variety shown in the following ruling will be found, with its accessories, quite sufficient for every purpose:—

| Accession No. | Author. | Brief Title. | Place of Publication. | Date of Publication. | No. of Vols. |
|---------------|---------|--------------|-----------------------|----------------------|--------------|
| | | | | | |

FIG. 102.—Stock Book.—Left-hand Folio (Section 300).

| Class No. | Binding. | Donor or Vendor. | Date of Receipt. | Price. | | | Special Collection. | Withdrawal Book. | Remarks. |
|-----------|----------|------------------|------------------|--------|--|--|---------------------|------------------|----------|
| | | | | | | | | | |
| | | | | | | | | | |

FIG. 103.—Stock Book.—Right-hand Folio (Section 300).

There does not seem to be any obvious advantage in the American plan of printing the accession numbers progressively down each page, as this renders it impossible to re-enter a new book which has been given a withdrawn number, and there is a

decided waste in using up from two to a hundred lines for a single work.

301. The stock book now recommended can be adapted to any system of classification, and when used in conjunction with the annual abstract sheets, ruled as shown below, the exact position of the stock can be easily and correctly ascertained.

| Page. | Classification. | Total Vols. | Bought. | Presented. | Special Collections. | |
|-------|-----------------|-------------|---------|------------|----------------------|--|
| | | | | | | |

Fig. 104.—Abstract Sheet for Stock and Withdrawals Books (Section 301).

302. Every book received into the library must be entered in the stock book, and a separate book should be kept for the reference and lending departments and for every branch. Provision is made in the ruling for any needful cross-reference to the withdrawals book, and a column is used for any necessary remarks required to further elucidate the history of each book. When a book is discarded it is entered in the withdrawals book, and the page of this register is carried into the appropriate column in the stock book against the original entry. The stock is balanced annually by the withdrawals of the year being deducted from the total stock as ascertained at the end of the previous year, plus all the new additions. Withdrawn numbers should be applied to new books so as to prevent blanks in the sequence, and such books must be entered in the stock book in its chronological order, and cross-references made between the

new and original entries. This will cause occasional irregularities in the progression of numbers of the "Accession Number" column, but it is of much greater importance not to allow extensive blanks to occur in this series of numbers, as it will play havoc with the charging system later on. This method of re-entering cannot be done with stock books having the accession numbers ready printed, and librarians who use this form must make up their minds to run a very irregular series of numbers.

303. The withdrawals book is the necessary complement of the stock book, and in it is entered every book permanently withdrawn from the library for any reason. The ruling given below will show better than description its scope and style:—

| Date of With-drawal. | Accession No. | Author. | Brief Title. | No. of Vols. | Class No. | Remarks. |
|----------------------|---------------|---------|--------------|--------------|-----------|----------|
| | | | | | | |

FIG. 105.—Withdrawals Book (Section 303).

In the enumeration of the stock of a library no distinction should be made between a book and a pamphlet. Every number represents a complete item, and the mere number of pages or subject-matter should not be allowed to enter into the question. For accession purposes a pamphlet is a book or work, whether it extends to a hundred pages or consists of but four.

304. REFERENCE LIST OF AUTHORITIES:—

Jast, L. S. Accessions: the checking of the processes. L., N. S., v. 1, p. 152.

Sec. 304]

ACCESSION METHODS.

Jast, L. S. The treatment of parliamentary papers. L. W., 1901, p. 147.

Jones, G. M. Accession department. (Book selection, orders, withdrawals, etc., with elaborate bibliography.) U. S. Educ. Rept., 1892-1893, v. 1, p. 809.

Savage, E. A. The stock register. L. W., v. 3, p. 11.

Willecock, W. J. Recording, replacing and disposal of worn-out books. L. W., 1901, p. 91.

For list of abbreviations see Section 88.

DIVISION VI.

CLASSIFICATION AND SHELF ARRANGEMENT.

CHAPTER XVIII.

GENERAL PRINCIPLES.

305. General.—Classification, which is one of the most important departments of librarianship, has not received the attention from British librarians due to its value as an aid to book selection, arrangement and cataloguing. While Continental and American librarians and bibliographers have been devoting an immense deal of time, research and intelligence to the study of systematic book classification, English librarians have contented themselves with methods of the most elementary kind, which, as the stream of literature broadens and deepens, become more and more inefficient and unsuitable. Roughly, the plan most in vogue in English public libraries is to establish from six to twenty main classes like A Theology, B Sciences, C Biography, D History, E Fiction, etc., and to number the books in each class consecutively as received, without regard to their subjects. The only effect of this is to bring together in one huge, undigested mass, all the novels and all the works of travel, etc., but it does not assemble in one place all the novels by one particular author, nor all the separate works on England, Yorkshire, London, etc. A more chaotic and unbusinesslike arrangement probably does not exist anywhere, in any department of life, than in a numerically arranged English public library on the plan just described. It is a mere wilderness of books dumped down on the shelves, without regard to topic relationships, or even an elementary idea of order or consistency, and the only parallels

to its unorganised confusion of which we can think are the heterogeneous contents of a dust-bin or a marine store! If every business enterprise were managed and arranged with the same bold disregard to classification as the majority of English public libraries, the financial and moral collapse of all branches of human endeavour would be an assured thing in a few short years. It is true that all books *are* books, just as it is equally true that all birds *are* birds, and all fishes *are* fishes, save, perhaps, whales—but on this point Herman Melville, the novelist, who knew a whale when he saw one, held views very much opposed to those of the academical naturalists. However that may be, it is an undoubted fact that neither birds nor fishes are lumped together as objects of equal qualities and characteristics, either by naturalists, bird fanciers, poulterers, anglers or fishmongers. Each has a minute scheme of classification, whereby not only is a division made into main classes, but all species and related specimens are kept separate and specially distinguished. We are not aware of a single profession, art, business or science, in which minute classification is not recognised as a perfectly natural and absolutely essential requirement; and it is mournful to have to record that the only places where disorder and topsy-turvydom are established and cherished—English municipal libraries—are just the very places where minute and scientific classification is most required and expected.

306. It is somewhat late to advance a plea for exact classification in English public libraries, in view of the fact that systematic schemes have been in successful practical operation in America, the leading European countries, and a few British libraries, for nearly thirty years; but some arguments in favour may be permissible, as so much apathy still exists in England. The importance of the subject has been recognised by various British librarians, among whom may be honourably named Mr. Archer and Mr. Lyster of the National Library of Ireland, and Mr. Jast of the Croydon Public Libraries. Strange, too, the first systematic account of classification schemes¹ is by a

¹ *Manual of Library Classification and Shelf Arrangement.* By James D. Brown. London, 1898.

British librarian, so that there is no lack of evidence to prove that considerable interest is manifested in the subject in Britain, and that much promise of great development in the future is evident. Journals like the *Library*, *Library World* and *Library Association Record* also devote some space to the subject, and the literature is steadily growing. In view of all this, a quotation from a paper read some years ago may serve to present, in a very brief form, some of the main reasons why systematic classification should be substituted for the haphazard numerical arrangements used in the majority of English public libraries.

307. "The rise of the unclassified library is comparatively recent, and there is no doubt the plan of numbering books in one progressive series, or in several such series, was a simple device adopted by unskilled and uneducated librarians to facilitate the finding of books, for issuing purposes, in cases where borrowers handed in long lists of books from which the assistants had to serve the first one found on the shelves. This plan was soon discovered to be the easiest to apply when indicators were first introduced twenty years ago, and so most libraries have gradually degenerated into chaotic masses of books, thrown together irrespective of topical relationships, and only discoverable by arbitrary numbers which effectually disguise authorships, subject-matter and individuality. The key to this chaos is supposed to be the dictionary catalogue, but any one who closely studies its main features will soon be convinced that it is little more than a very meagre index to the contents of a library. And apart from defects in compilation, the failure to describe inaccessible books makes such a catalogue all but useless to a vast majority of readers, as I shall show farther on. Now, I should like much to know what makes exact classification such a bugbear to so many librarians, and why one of them at least has written a paper to prove that classification of any sort is useless? Is it possible the opinion has arisen in many minds that the public library is to be dominated for ever by the makeshift numerical finding methods which were introduced by incompetent novices in the inter-

Sec. 308] CLASSIFICATION : GENERAL PRINCIPLES.

mediate stage of library progress? Are we for ever to follow in the footsteps of mere gropers in the early dawn of public librarianship, whose very ignorance and lack of experience were sufficient excuse for the childishness of their methods!

308. "There can hardly be a doubt that the weak points in the economy of most of the British public libraries are their classification and cataloguing. My study of the former has convinced me that the originator of the almost universal numerical system must have been an auctioneer or a graduate from a Sunday school library. The charming simplicity of arithmetical progression could only possess fascination for one whose erstwhile daily practice in rudimentary classification was to stick consecutive numbers, first, on a water-colour drawing by David Cox; next, on a kitchen table; and next, perhaps, on a Crown-Derby chamber utensil. I am not by any means condemning outright the numerical shelf system which is dignified with the name of classification, because experience has taught me that every method has, or had, an original value, local if not general. So it is with the numerical shelf arrangement. It has two advantages which, in my opinion, are wrongfully held to outweigh everything else. By means of it, there is a maximum of ease in initial arrangement and a less, but sufficient, degree of certainty in finding any given number. One naturally expects to find D90 between D89 and D91 if the vagrant assistant has not put C90 or B90 in its place, while dreaming of higher things. When these points are allowed, the sum total of advantages in a numerical classification has been given. It is when you come to examine closely this shelf arrangement which is misnamed classification that its defects become obvious. The mere fact that it is a handy and easy method of finding books, which any child could understand, is no reason at all why it should be regarded as an absolute and perfect plan of classing and shelving. There is positively nothing very clever in gathering two or three thousand volumes on various sciences, arts or trades, calling them class D, and then proceeding to number them higgledy-piggledy from 1 onwards, and finally to dump them on to the

shelves in that order. This is not classification at all, but simply shelf numbering in its crudest form. Suppose we analyse this class, and take chemistry as a subject suitable for our purpose. To ascertain the distribution of the literature of chemistry in a library numerically arranged, I take as a text-book a representative dictionary catalogue. From it I find that the books on chemistry are numbered in a sequence like this: 68, 78, 83, 84, 85, 174, 709, 720 and so on for forty entries up to number 2,454. Thus the forty works on chemistry are scattered over a series of about one hundred shelves, containing perhaps 3,000 volumes. How is it possible for an assistant to realise in any kind of concrete form the possessions of the library on chemistry, or any other topic, when the books are spread and concealed like this? As I pointed out before, the catalogue is of no great assistance, partly because, as a rule, it is not up-to-date, partly because the dictionary principle of cataloguing under the smallest specific heading prevents main classes from being shown in their subjective relationships, and most catalogue subject-headings present a heterogeneous mass of different classes. In the catalogue which forms our text-book there are no references from chemistry to metallurgy, electro-metallurgy, mineralogy, nor to any of the purely chemical trades. An assistant is, therefore, unable to become thoroughly acquainted in an easy manner with any particular subject. Chemistry, for example, represents but an item in class D, its component parts being widely distributed because of the tyranny of numerical progression, and the individuality of every other distinct subject is similarly submerged in a flood of irrelevant books. This is not only an almost insurmountable obstacle to the progress of assistants in learning the literature of subjects, but it injuriously affects the convenience of the public in many ways. Suppose a reader wishes the picture of a kangaroo. One method of helping him will at once occur to the ordinary mechanical assistant. He will say, 'If you don't find anything under "kangaroo" in the catalogue, then we've got nothing'. On the other hand, the intelligent assistant will think of looking up a few natural history books, or a few books

Sec. 308] CLASSIFICATION: GENERAL PRINCIPLES.

on Australia. But, in either case, the time he will waste in hunting for a kangaroo in widely scattered books on subjects likely to prove helpful will be enormous. There are twenty-nine entries in my typical catalogue under 'Australia,' representing books very widely separated on the shelves, and the mere physical task of looking for these in class C, etc., not to speak of thirty or forty entries under 'Natural History' in class D, is enough to daunt the most willing assistant. Now compare this with the library where close classification is followed. All the books on Australia, or on parts of that continent, will be found together in close proximity, the oldest as well as the latest works on the same topic adjoining each other. It becomes a matter of comparative ease for an assistant to at once pick out a book with the picture of a kangaroo. I could multiply instances by the score to show the same kind of thing, but will confine myself to another example from the class of fiction. The theory of the numerical shelf arrangement is that by means of blank numbers left after authors' names in fiction, a rough alphabetical arrangement can be maintained. In actual practice it is found that a very short time suffices to fill the blanks, and, in the course of years, the works of every popular author have to be shelved in from two to ten widely separated places, while the catalogue entries of the same authors are scattered through the original catalogue, several supplements, the placarded list of latest additions, and perhaps a show-case. There is absolutely no complete record in one place of the works of any novelist possessed by the library. Therefore, when the nice old lady comes along, who has had her eyesight prematurely weakened by too much indicator-scanning and has left her supplements at home, she is an object for the sympathetic gallantry of the tender-hearted assistant. Well then, when she finds that the books she set her mind on are out, she appeals naturally to the gallant young man aforesaid, in some such terms as these: '*The Seamy Side* is out; are any other of Besant's works in?' Such a question as this reduces the tender-hearted youth of most libraries to a quandary, as he knows that, owing to his

chief's distributive classification, Besant's novels are, in vulgar parlance, 'all over the shop'. He halts, therefore, between exercising his imagination or his legs, being desirous of obliging, yet knowing that in doing it he wastes the time of other inquirers, and subjects himself to some rather agile sprinting. These, then, are one or two glaring defects of the numerical system, and no doubt every thinking or observing assistant is aware of many similar shortcomings.

"The drift of the foregoing remarks may now be gathered by the intelligent assistant to mean that libraries ought to be properly classified instead of merely numbered for convenience of finding. To subordinate the whole of a library's methods to the simplification of the humble art of handing out books is, in my opinion, to degrade the science of librarianship to the comparatively low level of the auction room or the drug store. The relation between the placing and finding of books can be as intimate or remote as wished. What I wish to impress is that any close or exact scheme of classification can be adapted to libraries worked with or without indicators in many simple and different ways, and yet leave abundant scope for the exercise of ingenuity in devising other methods. I am not urging the use of any particular scheme, so long as the final result is that books on every subject of importance are to be found all together on the shelves. Every library should have its books on Africa, China, botany, music, mechanics, and similar definite subjects, arranged in groups on the same or adjoining shelves, but in such a way that, at a glance, any one can see the actual material aspect of the topic, and so form an estimate of the library's wealth or poverty in each particular group."¹

309. Some further remarks on the same subject from the work on classification by J. D. Brown will fitly close this chapter on the general principles of library classification: "It must be allowed that within the past five or six years a disposition has been manifested among English librarians to consider more closely the claims of systematic classification on the shelves. Where previously a tendency existed to scoff at such accuracy

¹ From an article in the *Library*, 1897, by James D. Brown.

Sec. 309] CLASSIFICATION : GENERAL PRINCIPLES.

as a vain and unattainable ideal, there is now to be found a spirit of inquiry which will doubtless lead to a complete change of attitude in the future. What has helped towards the formation of this growth of opinion more than anything else has been the appearance and acceptance of various valuable and ingenious American systems, worked out to the smallest detail, completely indexed and made widely available through the medium of print. These have, to use a homely phrase, 'knocked the wind' out of nearly every objector to close classification, by demonstrating not only its practicability, but also its general simplicity and usefulness. The objections heard against systematic classifications are no longer based upon such points as the impossibility of an all-round agreement being arrived at as to main classes, or the undesirability or difficulty of making one scheme to suit all libraries; but are directed almost entirely to criticism of such details as where in a main class to put given topics. The general acceptance of close classifications for reference libraries tends also to confirm our contention that the principle has been adopted very largely, though considerations of expediency may delay the execution in some libraries for several years. The labour involved in rearranging and properly classifying a large library which has for a long time been growing up in hopeless confusion under some primitive numerical plan, is certain to deter many librarians or committees from undertaking the work. But the gradual adoption of scientific systems here and there in Britain points to the ultimate extension of close classifications to all kinds of libraries. The plea frequently advanced that in small libraries close classification upon the shelves is unnecessary has scarcely any force in these times, as, owing to the cheapness of books and the increase of means, libraries are growing at a rate hitherto unknown. That is, therefore, a good reason for urging that libraries should be classified from their very foundations in such a way that, when mere topics have grown as large in bulk as original main classes, they shall be found together on the shelves, and not scattered over the whole collection. The practical convenience of this could be illustrated by a hundred instances; but most librarians are painfully aware.

of the drawbacks, which need not now be recapitulated. The necessity for training library assistants thoroughly in all that pertains to the educational side of their work, points to the need for such classificatory systems as will enable them to supply or suggest sources of information as quickly and effectually as possible, and this can only be accomplished by means of an arrangement which gathers as far as possible in one place all books on the same subject. It is only by this means that librarians or assistants can hope to become familiar with the material aspect of books on important subjects, and thereby be tempted to search for information, which can only be obtained by enormous labour if the books on a subject are scattered about in several hundreds of different places. In fact, it is obvious that, with subjects widely separated in a large library, assistants will be disinclined to hunt for information which can only be found after severe physical exertion by actual examination of books. No catalogue describes books so minutely that readers can obtain a good general idea of their scope and contents, and it is therefore in the public interest that books should be so arranged as to be accessible for easy reference in minute subdivisions under main classes. The ambition of the modern librarian to be considered a man of learning and method, as expressed at every conference of the Library Association, is another good reason why he should justify his claims by the use of practical scientific systems in place of elementary and inconvenient ones. This sort of simplicity may be all right for an easy start in library methods; but it is in after years, when rapid and continuous growth has made libraries into gigantic stores of unclassified and widely distributed books, that the un wisdom of such unmethodical practice is demonstrated. There are plenty of old libraries now, which have grown up in a haphazard way, waiting for complete reorganisation on systematic lines. But the labour involved is too considerable to be lightly faced; and so the work is postponed, till ultimately it will assume gigantic dimensions, and cost comparatively large sums to execute."¹

¹ *Manual of Library Classification*, p. 24.

Sec. 310] CLASSIFICATION : GENERAL PRINCIPLES.

310. REFERENCE LIST OF AUTHORITIES :—

Brown, J. D. *Manual of library classification and shelf arrangement*, 1898.

Dana, J. C. *Classification*. See his "Library Primer," pp. 78-91.

Edwards, E. *Memoirs of libraries*, 1859, v. 2, pp. 761-881.

Grassel, A. *Bibliothekslehre*, 1897 and 1902.

Jast, L. S. *Library classification*. *Greenwood's Year Book*, 1900, p. 21.

Kephart, H. *Classification*. *U. S. Educ. Rept.*, 1892-1893, v. 1, p. 861.

(Contains valuable bibliography and analysis.)

Petzholdt, J. *Bibliotheca bibliographica*, 1866.

Richardson, E. C. *The classification of books*. *Lib. J.*, 1901, p. 124.

— *Classification theoretical and practical* . . . 1901.

For list of abbreviations see Section 88.

CHAPTER XIX.

SYSTEMATIC CLASSIFICATION SCHEMES.

311. **General.**—Quite a large number of classification schemes have been devised by Continental, American and British librarians, in which books are systematically arranged according to related topics, and marked with a notation which enables any book or subject to be readily distinguished by its number, for purposes of shelving, charging and cataloguing. All the best known of such schemes are described in Brown's *Manual of Library Classification*, London, 1898, which is, with Richardson's work, practically the only text-book on the subject ever published. It will be sufficient to merely name the methods of Harris, Perkins and Smith, of America; Edwards and Sonnenschein, of England; Bonazzi, of Italy; and Hartwig, of Germany, which, with the well-known French scheme of Brunet, make up a very interesting collection of international contributions to the classification of books. None of these schemes have been adopted in more than one or two libraries, so that their influence is not sufficiently widespread to make any further description of their details necessary. It will be much more helpful to librarians if we describe the chief systems of classification which fulfil every requirement as regards notation and general adaptability to library work, and which have been put to the practical test of application in a number of different libraries. The systems in question are the Adjustable, Decimal and Expansive, the first being an English scheme and the two others American. They have all been extensively adopted, and each exists as a separate printed work, with an index; a vital part of any method of classification. Unprinted schemes, or those of merely theoretical interest, have very little

Sec. 313] SYSTEMATIC CLASSIFICATION SCHEMES.

practical value, and though every librarian has his own ideas of classification, and generally manages to graft them on to the scheme of some other person, and even to nibble away at his original, it is the best and wisest course to adopt a complete, printed and accessible scheme with as little modification as possible.

312. Adjustable Classification.—This is an English scheme introduced in 1898, and especially designed for the needs of British municipal libraries. Its notation is so elastic that a new subject can be introduced at any point, and it is not limited by divisional numbers arranged in a hard and fast sequence like the Decimal system, or by alphabetical divisions, like those of the Expansive, in which a limit is placed upon the movement of every class. The Adjustable is arranged in a series of independent classes, and instead of the main divisions being bound in a numerical sequence, qualified by sectional sub-numbers, they are numbered in one series of sections of equal value. The even numbers only are used in the first issue of the scheme, thus allowing for it being doubled without change or trouble. The scheme is adapted to the class of books most often to be found in British municipal libraries, and the geographical sections are worked out much more fully than usual. Headings are provided throughout the system for general and special, or departmental, works, thus avoiding one of the difficulties which occurs in other methods. By providing separate classes for Biography and History, another decided advantage is gained.

313. The main classes and divisions of the ADJUSTABLE CLASSIFICATION are as follows:—

| CLASS A—SCIENCE. | |
|---------------------|---|
| 2-8 General. | 140 Amphibians. |
| 10-28 Biology. | 142-148 Fishes. |
| 30-50 Zoology, Man. | 150 Invertebrates. |
| 52-68 „ Animal. | 152 Crustacea. |
| 70 Vertebrates. | 154 Arachnida. |
| 72-104 Mammals. | 156 Myriapoda. |
| 106-128 Birds. | 158-180 Insects. |
| 130-138 Reptiles. | 182 Molluscs. |
| | 184-192 Brachiopoda, Echinoderma, etc. |

- 194 Protozoa.
 196-222 Botany.
 224-248 Geology.
 250-262 Chemistry.
 264-288 Physics.
 290-302 Physiography.
 304-320 Astronomy.
 322-350 Mathematics.
 352-362 Occult Sciences.

CLASS B—USEFUL ARTS.

- 2-6 General.
 8-18 Inventions.
 20 Recipes.
 22-38 Agriculture.
 40-58 Gardening.
 60-74 Building.
 76-80 Engineering, general.
 82-86 " Aerial.
 88-92 " Civil.
 94-102 " Electrical.
 104-112 " Mechanical.
 114-142 " Military.
 144-168 " Naval.
 170-190 " Mining.
 192-196 " Railway.
 198-214 " Steam and Gas.
 216-238 Metallurgy.
 240-242 Manufactures, general.
 244-272 Book Production.
 274-296 Chemical Trades.
 298 Clothing.
 300-304 Coach-building.
 306-312 Fisheries.
 314-316 Food Production.
 318-324 Gas Production.
 326-328 Glass.
 330-334 Leather.
 336-374 Metal-working.
 376-378 Musical Instruments.
 380-386 Pottery.
 388-402 Textiles.
 404-420 Wood-working.
 422 Shopkeepers' Manuals.

- 424-480 Medical Science.
 482-486 Veterinary Medicine.
 488-508 Household Arts.

CLASS C—FINE AND RECREATIVE ARTS.

- 2-16 Fine Arts, general.
 18-54 Painting.
 56-68 Drawing.
 70-102 Decoration.
 104-140 Engraving, etc.
 142-154 Photography.
 156-160 Writing.
 162-166 Shorthand.
 168-186 Collecting.
 188-236 Architecture.
 238-250 Sculpture.
 252-288 Music, general, history, etc.
 292-424 " Instruments.
 426-434 " Voice.
 436 " Operas.
 438-440 " Oratorios and Cantatas.
 442-462 " Church.
 464-488 " Vocal and Songs.
 490-492 Recreative Arts.
 494-658 Games and Sports.

CLASS D—SOCIAL SCIENCE.

- 2-8 General.
 10-92 Manners, Customs, etc.
 94-150 Political Economy.
 152-272 Government and Politics.
 274-354 Law.
 356-398 Commerce, Finance.
 400-424 Communications.
 426-484 Education.

CLASS E—PHILOSOPHY AND RELIGION.

- 2-18 Philosophy, general.
 20-24 Logic, etc.

Sec. 314] SYSTEMATIC CLASSIFICATION SCHEMES.

- 26-86 Mental Physiology, etc.
- 88 Ethics.
- 42 Religion, general.
- 44-80 Theology, general.
- 82-152 Bible.
- 154-166 Fathers, Councils, etc.
- 170-284 Christianity and its Churches.
- 286-384 Christian Theology.
- 386-442 Non-Christian Religions.
- 444-470 Mythology and Folk-lore.

CLASS F—HISTORY AND GEOGRAPHY.

- 2-26 History, general.
- 28-62 Ancient and Dispersed Nations.
- 64-66 Modern History, general.
- 68-86 Geography, general.
- 88-196 Africa.
- 198-452 America.
- 454-558 Asia.
- 560-1,258 Europe.
- 1,260-1,350 Oceania.
- 1,352-1,364 Polar Regions.

CLASS G—BIOGRAPHY.

- 2 General.
- 4-28 National.
- 30-86 Class.
- 88 Individual Biography.
- 90-102 Genealogy, etc.
- 104-116 Heraldry.

CLASS H—LANGUAGE AND LITERATURE.

- 2-16 Language, general.
- 18-26 " Africa.
- 28-34 " America.
- 36-108 " Asia.
- 110-294 " Europe.
- 296-302 " Polynesia, etc.
- 304-312 Names.
- 314-324 Oratory, etc.
- 326-362 Literary History.
- 364-376 Bibliography.
- 378-404 Libraries, etc.

CLASS J—POETRY AND DRAMA.

- 2-8 Poetry, general.
- 10-44 National Collections.
- 46-60 Class "
 - 62 Individual authors.
- 64-76 Drama, general.
- 78-80 Collections.
 - 82 Individual authors.

CLASS K—PROSE FICTION.

- 2-10 History and Collections.
 - 12 Individual authors.
- 14-18 Juvenile Fiction.

CLASS L—MISCELLANEOUS.

- 2-32 Encyclopædias, Periodicals, Essays, etc.
- 34 Composite Works (or books treating of more than three definite topics).

This scheme is published separately as *Adjustable Classification for Libraries, with Index*, by James D. Brown, London, 1898. Enlarged and complete edition in preparation.

314. Decimal Classification.—Invented by Mr. Melvil Dewey in 1873-1876, and since greatly enlarged and improved. As indicated by its name, the system is divided into groups of ten, and the result is to obtain an admirable notation at the expense of natural and fair proportion among the classes.

This method is one of the oldest and most widely adopted of any, and its merits entitle it to considerable respect and examination. Hardly any librarian can apply it exactly as it stands, because of the enormous congestion which occurs at 800 and 900 owing to the presence of Prose Fiction and Poetry in the former, and the mingling of Biography, History and Geography in the latter. The usual plan is to treat Fiction as an entirely separate class, and to remove Biography from 900 and make it a supplementary class. The plan of classing the works of individual poets and essayists by nationality has no practical advantage whatsoever; and the somewhat inconsistent method of classing Individual Biography by class groups like statesmen, authors, etc., is equally useless. With collections it is quite a different matter; but experience has shown that individuality should never be merged in class, so far at least as Fiction, Poetry, Essays and Individual Biography are concerned. This is a case in which logical order must give way to practical necessity. By Mr. Dewey's logical method, a reader in search of Heine's *Poems* has first to ascertain the author's nationality and epoch before he can find the book, and this, without the index, would be a hopeless search to an ignorant man in an open-access³ library. With the practical system of arranging all poets alphabetically by their names, the same ignorant individual can go straight to his objective. So with the biography of individuals. An alphabetical arrangement by names of subjects is infinitely more useful than one by classes, particularly as many eminent men can be placed in so many different categories. Was Benjamin Franklin a statesman, scientist or author? What about Buckingham?

[Who] in the course of one revolving moon
Was chemist, fiddler, statesman and buffoon,

and hundreds of other versatile men of genius.

315. These points constitute some of the main defects of the DECIMAL CLASSIFICATION, and we shall now proceed to set out its chief divisions and subdivisions.

Sec. 315] SYSTEMATIC CLASSIFICATION SCHEMES.

000 GENERAL WORKS.

- 010 Bibliography.
- 020 Library Economy.
- 030 General Cyclopædias.
- 040 " Collections.
- 050 " Periodicals.
- 060 " Societies.
- 070 Newspapers.
- 080 Special Libraries.
- 090 Book Rarities.

100 PHILOSOPHY.

- 110 Metaphysics.
- 120 " Special Topics.
- 130 Mind and Body.
- 140 Philosophical Systems.
- 150 Mental Faculties, Psychology.
- 160 Logic.
- 170 Ethics.
- 180 Ancient Philosophers.
- 190 Modern "

200 RELIGION.

- 210 Natural Theology.
- 220 Bible.
- 230 Doctrinal Theology.
- 240 Devotional and Practical.
- 250 Homiletic, Pastoral, etc.
- 260 Church Institutions.
- 270 Religious History.
- 280 Christian Churches and Sects.
- 290 Non-Christian Religions.

300 SOCIOLOGY.

- 310 Statistics.
- 320 Political Science.
- 330 " Economy.
- 340 Law.
- 350 Administration.
- 360 Associations.
- 370 Education.

380 Commerce, etc.

390 Customs, Costumes, Folk-lore.

400 PHILOLOGY.

- 410 Comparative.
- 420 English.
- 430 German.
- 440 French.
- 450 Italian.
- 460 Spanish.
- 470 Latin.
- 480 Greek.
- 490 Minor Languages.

500 NATURAL SCIENCE.

- 510 Mathematics.
- 520 Astronomy.
- 530 Physics.
- 540 Chemistry.
- 550 Geology.
- 560 Paleontology.
- 570 Biology.
- 580 Botany.
- 590 Zoology.

600 USEFUL ARTS.

- 610 Medicine.
- 620 Engineering.
- 630 Agriculture.
- 640 Domestic Economy.
- 650 Communications.
- 660 Chemical Technology.
- 670 Manufactures.
- 680 Mechanic Trades.
- 690 Building.

700 FINE ARTS.

- 710 Landscape Gardening.
- 720 Architecture.
- 730 Sculpture.

| | | |
|--------------------------|--------------------------------|-----------|
| 740 Drawing, Decoration. | 880 Greek. | |
| 750 Painting. | 890 Minor Languages. | |
| 760 Engraving. | | |
| 770 Photography. | 900 HISTORY. | |
| 780 Music. | 910 Geography and Description. | |
| 790 Amusements. | 920 Biography. | |
| | 930 Ancient History. | |
| 800 LITERATURE. | 940 Europe. | |
| 810 American. | 950 Asia. | } Modern. |
| 820 English. | 960 Africa. | |
| 830 German. | 970 N. America. | |
| 840 French. | 980 S. America. | |
| 850 Italian. | 990 Oceanica and | |
| 860 Spanish. | Polar Regions. | |
| 870 Latin. | | |

This scheme is published separately as *Tables and Index of the Decimal Classification and relative Index for arranging and cataloguing Libraries, Clippings, Notes, etc.*, by Melvil Dewey, Boston, fifth edition.

316. **Expansive Classification.**—This elaborate system was devised by Mr. C. A. Cutter, a well-known American librarian, and author of the celebrated code of *Rules for a Dictionary Catalogue*, which has been a text-book for years. The Expansive Classification has not been adopted to any extent in Britain, but is printed in a series of seven classifications of progressive fulness, and completely indexed, and so becomes one of the methods to be studied. The following description and list of headings are taken from Mr. Cutter's own account of the system:—

“The original feature of this notation is the use of letters to mark non-local subjects and figures (from 11 to 99) to mark places. This makes it possible to express the local relations of a subject in a perfectly unmistakable way, the letters never being used to signify countries and these figures never being used for any other subjects but countries. Thus 45 is England wherever it occurs; *e.g.*, F being history and G geography, F45 is the history of England, G45 the geography of England. This local notation can be used, not merely with the main

Sec. 316] SYSTEMATIC CLASSIFICATION SCHEMES.

classes, but in every subdivision, no matter how minute, which is worth dividing by countries. Whenever one wishes to separate what relates to England from other works on any subject one has only to add the two figures 45. Whenever one sees 45 in the mark of a book one knows that the book so marked treats its subject with special reference to England. This 'local list' by the figures gives marks to the eighty-eight most important countries. The addition of a third and sometimes a fourth figure gives marks for all the independent countries in the world. Parts of and places in countries are arranged alphabetically under each, and are marked either by the usual Cutter order table, which has initial letters followed by figures, or by a special Cutter order table composed of figures alone.

"Non-local subjects are marked with letters, first, to distinguish them from local subjects; and, second, because of the greater capacity. There are twenty-six main classes, A to Z. By adding a second letter, these are divided into 676 parts, and these, by adding a third letter, into 17,576 parts, making 18,278 in all, so that as one uses successively three, four or five characters, one gets respectively eighteen times, forty-six times and 118 times the capacity of a decimal notation. The result is, short marks, numerous subdivisions, much greater elasticity, much greater power to properly express the relations of subjects to one another, and their relations to subordinate subjects, and much more opportunity of making the different portions of the classification correspond to each other.

"The first part of the classification, as published, contains the first six classifications and a combined index to them all. The seventh, the fullest classification, will have ten sections. Five of them are published, each with its own index. Of two (Social Sciences and Language and Literature) about half is published. When these and the other three (Natural Sciences, Industrial Arts, Recreative and Fine Arts) are printed, with their indexes, a full index to the whole will be made.

317. "EXPANSIVE CLASSIFICATION. OUTLINE:—

| | | | |
|--------------------------------|---|---------|---|
| A | Generalia | F02 | Ancient history |
| A | General works | F08 | Modern history |
| Ae | General encyclopædias | F04 | Mediæval history |
| Ap | General periodicals | F11-F99 | History of single countries (using local list) |
| Ar | Reference works | Fa-Fw | Allied studies, as Chronology, Philosophy of history, History of civilisation, Antiquities, Numismatics, Chivalry, Heraldry |
| As | General societies | | |
| B-D Spiritual sciences | | | |
| B | Philosophy | G | Geography, Travels |
| Ba-Bf | National philosophies and Systems of philosophy | G11-G99 | Single countries (using local list) |
| Bg | Metaphysics | Ga | Ancient geography |
| Bh | Logic | Gf | Surveying and Map-making |
| Bi | Psychology | Gz | Maps |
| Bm | Moral philosophy | | |
| Br | Religion, Natural theology | H | Social sciences |
| Bt | Religions | Hb | Statistics |
| Bu | Folk-lore | Hc | Economics |
| Ca | Judaism | He | Production |
| Cb | Bible | Hf | Labour |
| Cc | Christianity | Hi | Slavery |
| Coe | Patristics | Hj | Transportation |
| Ce | Apologetics, Evidences | Hk | Distribution, Commerce |
| Cf | Doctrinal theology | Hm | Money |
| Ck | Ethical theology | Hn | Banking |
| Op | Ritual theology and Church polity | Hr | Private finance |
| Cx | Pastoral theology | Ht | Taxation and Public finance |
| Cz | Sermons | Hu | Tariff |
| D | Ecclesiastical history | Hw | Property, Capital |
| Dk | Particular churches and sects | Hx | Consumption |
| E-G Historical sciences | | | |
| E | Biography and Portraits | I | Demotics, Sociology |
| F-Fz | History | Ic | Crime |
| F | Universal history | Ig | Charity |
| | | Ih | Providence |
| | | Ik | Education |
| | | J | Civics, Government, Political science |

Sec. 317] SYSTEMATIC CLASSIFICATION SCHEMES.

| | | | |
|--------------|---|----|--|
| Ju | Constitutions and Politics | Re | Metallurgy |
| K | Legislation and Law | Rf | Agriculture |
| Kd | Public Documents | Rh | Horticulture |
| L-Q | Natural sciences | Ri | Silviculture |
| L | General works, Metrics | Rj | Animaliculture |
| <i>Lb-Lg</i> | <i>Number and space</i> | Rk | Chemic arts |
| Lb | Mathematics | Rl | Electric arts |
| <i>Lh-Lr</i> | <i>Matter and force</i> | Rm | Domestic arts |
| Lh | Physics | Rn | Food and Cookery |
| Lo | Chemistry | Ro | Constructive arts, Engineering |
| Lr | Astronomy | Rp | Building |
| <i>M-Q</i> | <i>Matter and life</i> | Rq | Sanitary engineering |
| M | Natural history | Rr | Hydraulic engineering |
| Mg | Geology, incl. Mineralogy, Crystallography, Physical geography, Meteorology, Paleontology | Rs | Transportation and Communication |
| My | Biology | Rt | Fabricative arts, Machinery, Manufacturing and Handicrafts |
| N | Botany | Ru | Protective arts, i.e., Military and Naval Arts, Life-preserving, Fire-fighting |
| | Cryptogams | Rv | Athletic and Recreative arts, Sports and Games |
| | Phanerogams | Vs | Gymnastics |
| O | Zoology | Vt | Theatre |
| | Invertebrates | Vv | Music |
| P | Vertebrates | W | Fine arts, plastic and graphic |
| Pg | Mammals | We | Landscape gardening |
| Pw | Anthropology, Ethnology, Ethnography. | Wf | Architecture |
| Q | Medicine | Wg | Casting, Baking, Firing |
| Q-Z | Arts | Wh | Drawing |
| R | General works, Exhibitions, Patents | Wi | Painting |
| Rd-Rg | Extractive arts | Wj | Engraving |
| Rd | Mining | Wk | Photography |

| | | | |
|-------|-------------------------------------|----|--|
| Ws | Decorative arts, including Costume | Zb | Rhetoric |
| X-Yf | Communicative arts (by language) | Zd | Writing |
| X | Philology | Zh | Printing |
| X | Inscriptions | Zk | Binding |
| X | Language | Zl | Distribution (Publishing and Bookselling) |
| Y | Literature | Zp | Storage and Use (Libraries) |
| Yf | English Fiction | Zu | Description (Zu Bibliography; Zx Selection of reading; Zy Literary history; Zz National bibliography)" |
| Z | Book arts (making and use of books) | | |
| Za-Zk | Production | | |
| Za | Authorship | | |

This scheme is published separately as *Expansive Classification*, by C. A. Cutter, Boston, 1891, etc., several sections.

CHAPTER XX.

PRACTICAL APPLICATION.

318. Numbers.—The class letters and numbers of all books should be written in the inside, preferably on the back or front of the title-page, and should also be carried on to the labels, book-cards and all other records. On the outside the class letters and numbers may be lettered in gilt or written on a suitable tag, which must be firmly pasted on the back about one inch and a half from the foot. It is best to place numbers at a point of the backs of books to ensure a regular and uniform marking. There is a considerable difference in rapidly scanning a level line of number and one which goes jumping about according to varying heights of volumes.

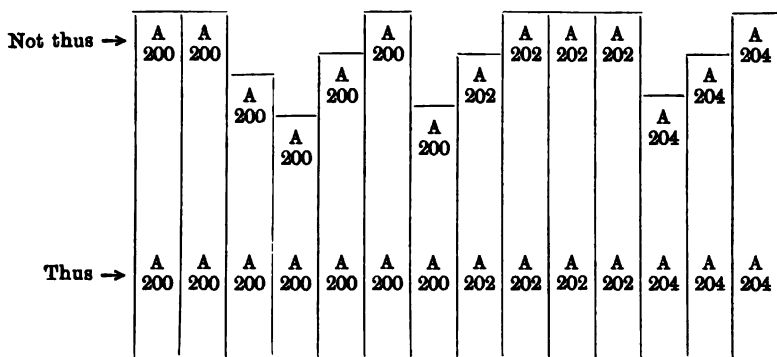

FIG. 106.—Lettering of Book Numbers (Section 318).

319. In the American classification systems, in which the class numbers are used for charging and all other purposes, it is necessary to provide a series of elaborate subsidiary marks to distinguish book from book in the same subdivision. Thus, in

the Decimal scheme, 621·18 is the number for books on boilers. If there are six books on this topic, some distinction must be used in charging to enable the librarian to know which book has been issued. Mr. Cutter has devised a table for this purpose, which is known as the "Cutter Author Marks," by which surnames are arranged according to their initials and qualified by a number thus:—

| | |
|---------------|-----------------|
| Abbott = Ab2. | Gardiner = G16. |
| Acland = Ac6. | Gerry = G36. |
| Cook = C77. | Gilman = G42. |
| Cousin = C83. | Shock = Sh8. |
| Crabb = C84. | |

The six books on boilers would accordingly be distinguished by receiving these author marks, and numbers might become:—

| | | | |
|------------|---|---|--------------------|
| 621·18 Ab2 | . | . | Abbott on Boilers. |
| 621·18 C83 | . | . | Cousin " |
| 621·18 G16 | . | . | Gardiner " |
| 621·18 Sh8 | . | . | Shock " |

But this elaboration, which has been imitated in England by Messrs. Jast and Anderson,¹ is really not required if books are properly lettered and the accession numbers are used for charging purposes.

320. The binder's lettering is generally quite sufficient to enable any book to be quickly found, even when one of fifty, provided the books are kept in alphabetical order of authors' names.

| | | | | | |
|----------|----------|----------|----------|----------|----------|
| Balfour | Balfour | Darwin | Lindley | Prantl | Vine |
| Botany | Botany | Botany | Botany | Botany | Botany |
| A 200 | A 200 | A 200 | A 200 | A 200 | A 200 |

FIG. 107.—Book-Marking (Section 320).

¹ *Library World*, 1900, pp. 120, 150, and 1901, p. 279.

Any reader or assistant can find a given author in a sequence like the opposite, or even if it were considerably disordered, without the slightest trouble; whereas in an open-access library it would be difficult for a reader to understand the meaning of A200 G16, 621·18 G16, or No C83. Every book has an individuality of its own, and it is better not to hide this under a lot of eccentric-looking numbers which only give in shorthand form what the book's own lettering gives in full. Shelf arrangement should, therefore, be according to the ordinary class numbers, and charging by means of accession numbers.

321. Book and Shelf Marking.—To prevent trouble it is

| COLOURS. | | |
|----------|---------|---------|
| Tier 1. | Tier 2. | Tier 3. |
| Blue | Yellow | Grey |
| Red | Mauve | Buff |
| Green | White | Blue |
| Yellow | Grey | Red |
| Mauve | Buff | Green |
| White | Blue | Yellow |
| Grey | Red | Mauve |
| Buff | Green | White |

better to have the class numbers stamped on the backs of books at once rather than to rely on tags or labels, which have a tendency to peel off on the slightest provocation. In open-access libraries using ordinary gilt lettering, a subsidiary marking has been adopted to prevent misplacement and aid replacement.

These marks are simple round spots of coloured enamel painted on the backs of the books, and they effectually prevent shelf being mixed with shelf and tier with tier. There are eight shelves in a tier, and eight distinctive colours are used, so that no colour is repeated in the same tier, and they are varied in every succeeding tier, so that adjoining shelves will not corre-

spond in the colour of their marking. As a further precaution, the class marks are placed at different heights on the backs of the books in each tier, so that, even if a red-marked book from

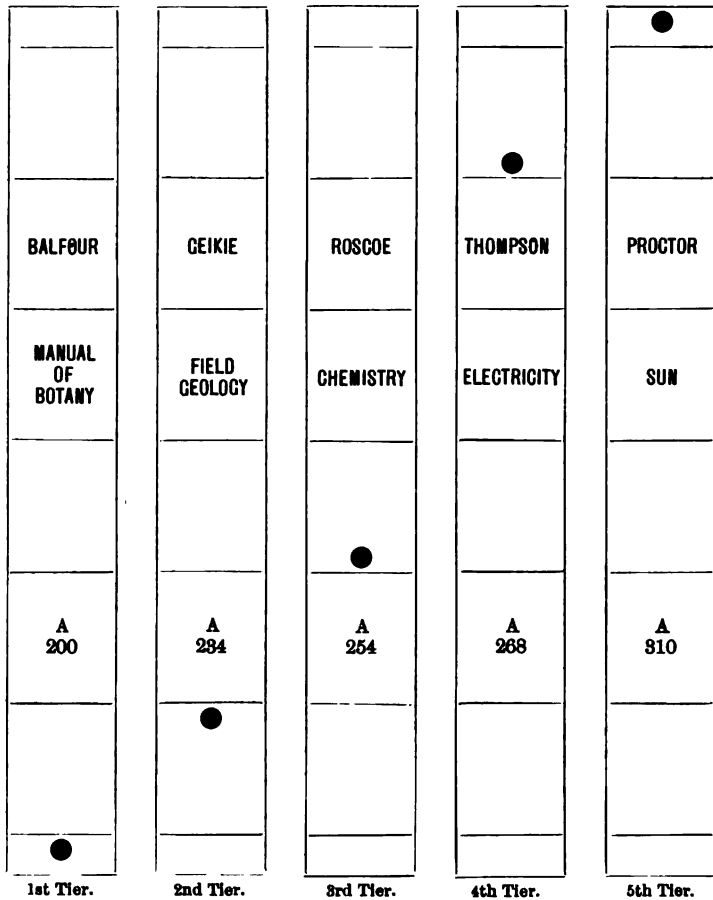

FIG. 108.—Tier Marking of Books (Section 921).

Tier 1 were placed among the red-marked books of Tier 3, there would still be a distinction. Of course the same level is maintained for each tier, by means of gauges, and the progression of

colours is observed. When a book moves forward to another shelf, the mark is painted over with the new colour, and when the book is moved to another tier, the mark is carefully scraped out and altered to suit the new location. As movement is not extensive in ordinary libraries, this alteration is only an occasional duty. The class numbers maintain the topic order on the shelves, and so the most common method of open-access shelf marking is complete. It has been argued that the class letters and numbers are all-sufficient to maintain order in a library which allows readers to go to the shelves, but on this point we require more experience. At any rate, there is no harm in taking simple precautions of this kind, which certainly possess the great advantage that if a book is misplaced it can be noticed instantly and rectified. We doubt if uniform labels or markings can be so easily detected, owing to there being nothing to show in an unmistakable way when a book is out of place. Uniform marks require a close scrutiny, the use of colours demands but a casual glance.¹ In closely classified libraries where there is no public access to the shelves, simple class numbers ought to be sufficient for staff purposes. The only additional point is that, perhaps, the accession numbers should also figure on the backs of the books, especially if an indicator is used for charging in the lending department.

322. In classified libraries it is well to thoroughly label the shelves, whether open to the public or not. A series of bold class labels on the top of each case, and plenty of topic labels on the shelves, together with the progressive class numbers boldly printed, and fixed to the end of each shelf, will be found a very great help to understanding the classification and finding the books. Shelf topic and number labels can be printed by the staff with the apparatus described in Section 249, and they can be fixed to the shelves by means of the label-holders mentioned in Section 195. For class numbers on the shelf-ends, the

¹ We understand that Mr. Jast, of Croydon Public Libraries, has a work in preparation on the whole theory, practice and philosophy of public access to shelves, and the problems arising therefrom, including descriptions of tagging and marking schemes.

xylonite label-holders will be found most economical and convenient, as they can be cut into inch widths. The following figure (No. 109) of a shelf-front with labels will give some idea of the application of these marks. The class number of the last topic only need be given. If a movable topic name is required, it may be fixed to the book-rest described in Section 196, Fig. 59.



FIG. 109.—Shelf-front showing Class divisions and Class number (Section 322).

The illustration below (No. 110) shows a class label for indicating the chief contents of a main class.

323. Shelf Register.—The shelf register is a record of the books as they stand on the shelves, and is the main guide used in stock-taking and otherwise checking the books. Cards are

| A | |
|---|------------------------|
| SCIENCE. | |
| 2-8 GENERAL | 250-262 CHEMISTRY |
| 10-28 BIOLOGY | 264-288 PHYSICS |
| 30-50 ANTHROPOLOGY-MAN | 290-302 PHYSIOGRAPHY |
| 52-194 ZOOLOGY-ANIMALS | 304-320 ASTRONOMY |
| 196-222 BOTANY | 322-350 MATHEMATICS |
| 224-248 GEOLOGY | 352-362 OCCULT SCIENCE |
| For Special Subjects <i>see</i> Index to Adjustable Classification. | |

FIG. 110.—Class Guide (Section 322).

sometimes used for this purpose, each work being entered on a separate card, the whole being arranged in trays in the order of the classification. This is not such a convenient method as the plan of using shelf-register sheets which occupy very little space and are more economical than other methods. Instead of using a separate sheet for each book, a single sheet is used for each class division or subdivision. The sheet is headed, as shown in

the subjoined ruling, with the class letter and number, and the books in the section are entered in author-alphabetical order to begin with, afterwards just as books are added.

| Ac- cession No. | Author. | Title. | Vols. | Dates of Check. | | | | | | | | | | | | | | | | |
|-----------------------|---------|--------------------|-------|-----------------|--|--|--|--|--|--|--|--|--|--|--|--|--|--|--|--|
| | | | | Mar. 6, 1900. | | | | | | | | | | | | | | | | |
| 5,216 | Balfour | Manual of Botany | 1 | √ | | | | | | | | | | | | | | | | |
| 15,621 | Henfrey | " | 1 | √ | | | | | | | | | | | | | | | | |
| 5,111 | Lindley | Elements of Botany | 1 | √ | | | | | | | | | | | | | | | | |

FIG. 111.—Shelf-Check Register (Section 323).

The narrow columns are reserved for checking the shelves annually or oftener as may be thought desirable. The date of check is written at the top, and the presence of the book indicated by a tick. In some open-access libraries stock is taken of the shelves twice in a year by means of these sheets. Missing books are not ticked, but noted for further search in the charging system and other records. When they turn up they are then ticked off. The sheets must be collated periodically, and any permanently missing books noted and entered in a special book ruled to show author and title, date missing, and with a column for recording any subsequent facts, such as its finding, replacement, or other means of recovery.

324. Dummies and Overflow Stock.—Sometimes the library becomes congested at certain places owing to limited space and rapid growth, and if weeding is not resorted to some of the less popular or old books must be removed to a supplementary store. There is scarcely a library which does not possess a second classification stored apart, where such crowded-out books are kept. On the shelf register these books can either be indicated by means of a red-ink cross, or they can be removed from the original and entered on supplementary sheets. Dummies, such as those described in Section 193, can also be used to show abstractions, especially in open-access libraries, or lists can be mounted on cards and kept beside each tier. The question of surplus stock is one which ought to be dealt with on the broad lines of the discarding policy discussed in Section 277, but, of course, an actual division of stock caused by overcrowding must be treated as recommended above.

Large and odd-sized books should be shelved in special presses, and their place in the classification can be indicated by means of dummies, as described in Section 193.

325. REFERENCE LIST OF AUTHORITIES:—

- Anderson, P. J. Author and work marks. *L. W.*, v. 3, p. 279.
Crawford, E. The shelf list. *P. L.*, 1899, p. 381.
Jast, L. S. New book number. *L. W.*, v. 3, pp. 120, 150.
Langton, H. H. Systems of shelf notation. *Lib. J.*, 1896, p. 441.
Lyster, T. W. Shelf classification. *L. A. R.*, v. 2, p. 399.
Size Notation. *Library Assoc. Report on. L.*, v. 4, p. 147.

DIVISION VII.

CATALOGUING, INDEXING, FILING.

CHAPTER XXI.

CATALOGUING RULES AND METHODS.

326. *General.*—Notwithstanding the number of rules and codes for different kinds of printed catalogues which have been published during the past fifty years, the average public library catalogue, both British and American, is about the most unsatisfactory piece of work connected with librarianship. Neither the meagre American "Finding-List," nor the so-called British "Dictionary Catalogue," supplies the information about books which readers require, while only an occasional example is compiled according to the elaborate codes of "Rules" laid down by Cutter and others. It is astonishing how few British dictionary catalogues go beyond the merely elementary part of Cutter's *Rules*. After providing the baldest kind of author, title, subject and occasional form entries, they nearly all stop short here, and do not proceed with the necessary co-ordination of subjects required in an alphabetical catalogue, nor with the equally necessary descriptions of books with obscure titles. A bare index of authors, subjects and titles with a few cross-references and collected lists, is all that the ordinary British municipal library provides in the way of aiding readers to select books with intelligence, and it must be confessed that such inventories, when not associated with direct access to the shelves, reduce the whole operation of book selection and reading to the level of a lottery. It has always seemed to us that quite a wrong conception has been formed of the purposes and limits of a library catalogue. Generally, it is assumed by the cataloguer that the reader knows exactly what book he requires,

and if a list is provided arranged like a dictionary in one alphabet of authors' names, titles and subject words, there can be no difficulty in a reader ascertaining if the book he wants is in the library. This is a useful assumption as far as it goes, but unfortunately it does not go far enough; while it has become the stereotyped plan on which British and many American municipal library catalogues have been compiled—to serve the sole purpose of enabling readers to discover for themselves if certain *known* works are possessed by the library. But this is only one out of many purposes for which catalogues should exist. Surely a catalogue intended for public use should be a guide to the contents of books, as well as a mere list of otherwise meaningless titles; because this is what such a catalogue becomes to the reader who only knows a few books. Suppose a library to consist of 20,000 volumes, and that the average reader wishes to use the catalogue for the purpose of discovering the literature of some particular subject. When he has exhausted his own scanty knowledge, which may extend to, perhaps, two or three of the books catalogued, he will be confronted with twenty, fifty, or even a hundred titles of other books about which he knows absolutely nothing, and the cataloguer does not, as a rule, provide a single scrap of note, hint, or even in some cases dates of publication, to guide the reader in his quest. As this condition will apply all round, it follows that something like 95 per cent. of the books in a public library will remain unknown and undescribed to practically all save a few special readers. This aspect of the question does not seem to have troubled the average librarian much, because for years he has gone on with his bare alphabetical lists, utterly oblivious of the fact that the ordinary, and also the student, reader requires some guidance with the books he *does not* know, as well as some note or means of discriminating between old and new books, complete and incomplete histories, detailed and outline text-books, etc. The first principle to be aimed at in any kind of catalogue is to inform the reader of the difference between books on the same subject, to indicate clearly their period and scope, and generally to aid him or her in making a

Sec. 326] CATALOGUING RULES AND METHODS.

useful choice. It is not enough to assume that the reader knows all this, as well as the character and authority of every author who ever wrote. Not one reader in a hundred knows exactly what he wants, even in the realms of fiction, and no catalogue which merely consists of transcripts of title-pages arranged in an alphabet of authors, titles and subjects, will afford very much assistance. We have referred to the dictionary or finding-list forms of catalogue specially, because they are the worst offenders in regard to withholding information, as well as being the most common variety in Britain and America. They are also the kind which can be most easily compiled with that sort of facility which is fatal to accuracy and good workmanship. As ordinarily understood and executed, a dictionary catalogue is simply an alphabetical arrangement of certain particulars selected from the title-pages of books, compiled in a purely mechanical manner, and most wasteful in every respect. A dictionary catalogue as it *could* be compiled, according to Cutter's *Rules*, plus more recent improvements, is a very different thing, but practically unattainable by any ordinary British public library on account of its excessive elaboration and probable cost. A properly compiled dictionary catalogue, fully annotated, with all its related parts clearly shown, and the literature of every main class displayed by means of cross-references, etc., would be a work of enormous labour, and when completed would be almost immediately out of date. The plan of the dictionary catalogue in its most comprehensive form provides for the title of a book being entered over and over again, as the needs of the case require, so that with the further elaboration of explanatory notes, references, the setting out of subdivisions of main classes in clear and systematic manner, and other necessary accessories, this type of catalogue would assume enormous proportions. It cannot be effectively dealt with in sections, owing to the absence of classification and the fact that such a procedure would not materially reduce the total cost, but very probably add to it. The only advantage of sectional publication in a dictionary catalogue would be to increase the opportunities for revision, and, it may be added, the cost of production could be spread over a longer period.

327. Here, then, we have the case of a library appliance of the utmost importance, which, in the vast majority of places, is compiled in the least useful and efficient form so far as the general public are concerned, and it becomes necessary to inquire if there are no alternatives to this plan which are more effective and economical. Within recent years the whole policy of the printed catalogue has been challenged, both in Britain and America, and there has grown up a considerable body of opinion opposed to the plan of issuing alphabetical catalogues in one volume, which are costly, difficult to keep up-to-date, and inefficient for purposes of conveying information about books. Some writers go so far as to advocate the abolition of the printed catalogue altogether, and the substitution of MS. varieties in card or sheaf form. Others would compromise this by printing lists of special collections, in addition to maintaining the MS. catalogue; while others would restrict cataloguing to the MS. form, supplemented by monthly or quarterly printed lists or bulletins of additions. The method which we would advise is not quite so drastic as any of these, while it would very materially reduce the cost and disadvantages of the printed dictionary catalogue, without losing any of its advantages. We advise the provision of a complete catalogue in manuscript form in every department or branch, compiled so as to show authors, titles, subjects, classes and all varieties of entry, to which annotations would be copiously applied. This could be maintained at a comparatively small annual cost in card or sheaf form, and would be always complete and up-to-date as a library catalogue. As over 80 per cent. of borrowers from lending libraries and all reference library readers must come to the libraries to be served, it follows that a catalogue always up-to-date and fully explanatory, kept at the very point of service, would be of immense value and convenience to the majority of public library users. For the comparatively small proportion of readers who have to send messengers, or who must make their choice of books at home, printed catalogues can be provided in a comparatively inexpensive form. Probably, in very many cases, the needs of the stay-at-home reader will be quite effectively supplied by

Sec. 328] CATALOGUING RULES AND METHODS.

means of a monthly or quarterly bulletin of additions, and every other reader can be most efficiently served by means of the printed class guides described in Chapter XXII.

328. Cataloguing Rules.—Consideration of the policy of cataloguing naturally brings forward the question of rules, and here, as before stated, we are confronted with more codes than good specimens compiled in accordance with them. The principal cataloguing codes are the following, and inquirers are referred to them for further information :—

1. Cutter (C. A.) Rules for a printed dictionary catalogue. 3rd ed. Washington, D.C. 1891.
2. Quinn (J. H.) Manual of Library Cataloguing. London. 1899.
3. Library Association Cataloguing Rules. Last revised in 1885, and published in the L. A. Year Books, and as a separate pamphlet in the L. A. Series, No. 5; and, with Index, by the New York State Library School, 1902. Bulletin, No. 77. This also contains the Bodleian (Oxford) and British Museum Rules. These rules are again under revision.
4. American Library Association. Condensed Rules for an author and title catalogue. See "Library Journal," 1883, pp. 251-254, 263-264. Also separate revised issue, Washington, 1902.
5. Perkins (F. B.) San Francisco cataloguing. 1884.
6. Dewey (M.) Rules for author and classed catalogues, with 52 facsimiles of sample cards. 4th ed. Boston. 1892.
7. Wheatley (H. B.) How to catalogue a library. London. 1889.
8. Linderfelt (K. A.) Eclectic card catalog rules. Author and titles. Based on Dziatzko's "Instruction," compared with the Rules of the British Museum, Cutter, Dewey, Perkins and other authorities. Boston. 1890.
9. Jast (L. S.) Classified and annotated cataloguing, suggestions and rules. See "Library World," vols. 1, 2, 3, 1898-1900. *Not completed.*

329. The whole of these codes of rules, save Nos. 1, 2 and 9, are drawn up for author and title catalogues, or for those in alphabetical form, and, as may be seen by reference to No. 8, are not distinguished by any great measure of unanimity. Every catalogue-rule compiler is generally a law unto himself, and the determination to insist on individuality is the only point of agreement we have been able to notice. A very large proportion of the rules drawn up only apply to university libraries and other special libraries which collect oriental books and those in the less known European languages. Largely for this reason they have little value for ordinary municipal libraries, the books in which rarely consist of any save those in the leading modern European languages. The best codes to follow are those of Cutter and Quinn for author entries, and Jast and Quinn for subject or class entries and annotations. But, unfortunately, none of these are well adapted for the type of catalogue we recommend—manuscript and printed class guides—and there is urgent need for a separate body of simple rules for this particular style of catalogue. Nos. 3 and 9 are being prepared for separate issue in a revised form, but until they are ready reliance must be placed upon the three codes already named. It is not the purpose of this book to give a complete code of cataloguing rules, but it may help young librarians, pending the appearance of a fuller and better series, to note a few of the vital rules for compiling class lists and full manuscript catalogues.

330. DRAFT RULES FOR COMPILING MS. AND CLASS CATALOGUES:—

1. Make one full entry under the subject, in the following order of particulars, avoiding capitals, save in the initials of proper or subject names.
 - (a) Author. Full name and distinguishing title, if any, and adding dates when persons of same name.
[Cutter.]
 - (b) Title. Full transcript, omitting redundant words, mottoes, etc. Give colophons of old books in full.
 - (c) Edition. State if 2nd, 3rd or other, as—2nd ed.

Sec. 330] CATALOGUING RULES AND METHODS.

- (d) Place of publication. Omitting London, which must be understood.
- (e) Date of publication. Use approximate dates for undated books, within square brackets.
- (f) Volumes. State number when more than one, as 2 v.
- (g) Size. When quarto or folio only, as 4to, fo.
- (h) Illustrations. These to be noted as in italic abbreviations following: Illustrated = *ill.*; coloured illustrations = *col. ill.*; maps; portraits = *port.* or *ports.*; plans; diagrams; music = *mus.* All other extra features of this kind to be stated in annotation.
- (j) Annotation. Best added in smaller type than the body of the title, and to be strictly confined to elucidating the contents of the book when not sufficiently indicated by the title-page. (See further at Rule 4.)
- (k) Class marks or numbers. To be placed at the most convenient part of the entry, whether manuscript or printed.

IMAGINARY EXAMPLE, illustrating the foregoing rule:—

C602. GAMES AND SPORTS—HAWKING.

Jones, William R, *Bishop of Oxford* (1650-1720). A complete guide to the art and practice of falconry. . . . 3rd ed. Oxford. 1713. 2 v. 4to, *col. ill., port.*

The first printed English work on falconry, with chapters on the breeding and rearing of hawks, and diagrams illustrating the flight of birds. First pub. in 1702.

2. Anonymous works are to be entered under the first word, not an article, with which the title-page begins. Where the authorship of an anonymous book has been definitely ascertained, and is an accepted fact, the entry must be made under the name of the author as in Rule 1, but the abbreviation *anon.* may be added immediately after the title. In the case of societies, periodicals, etc., references must be given from their towns of origin. Authorities for ascertained authorships will be the books on anonymous and pseudonymous literature noted among those in Sections 87 and 331.

IMAGINARY EXAMPLE:—

G60—CLASS BIOGRAPHY—MUSICIANS.

Dictionary of musicians, from the earliest to the present time. 1824-1825. 3 v., *ports.*

EXAMPLE OF ASCERTAINED AUTHORSHIP ENTRY:—

F1222—SPAIN, GEOGRAPHY AND TRAVELS.

Smith, Peter. Rambles in the ancient European home of the Moors. *Anon.* 1832.

3. Authors who have written, or write, under assumed names or pseudonyms, are to be entered under their real names, when these have been definitely ascertained, in the appropriate authorities named in Section 87. The system of using the family name, almost universally followed in all important biographical dictionaries, is much more natural, legal and accurate than the random system sometimes advocated of using the *best-known name*, whichever each librarian thinks that may be. A cross-reference from the pseudonym must, of course, be made in the author-index of a classified catalogue. Vernacular birth-names should be used in every case, with cross-references from Latinised or other adopted names.

EXAMPLE OF TREATMENT OF MAIN ENTRY:—

Hawkins, Anthony Hope—*Anthony Hope*. The Prisoner of Zenda.

EXAMPLE OF INDEX TREATMENT:—

Hope, Anthony. *See* Hawkins, Anthony Hope.

4. Annotations should be added to all entries which are not self-explanatory. They should be confined to elucidating or describing the contents of books, and never extended to criticism of their literary or other merits. The craze for critical "evaluation" or "appraisal" which has arisen within recent years should not be extended to catalogues of books issued at the public expense. The following points should be carefully observed in annotations:—

- (a) The period covered by the work should be indicated

Sec. 330] CATALOGUING RULES AND METHODS.

in the case of histories, biographies, etc., and the actual dates of occurrence in the case of works of travel, experiments, etc.

- (b) In the case of reprints, the dates of original publication should be given, as well as the dates of the new editions.
- (c) Names, words and phrases occurring in titles should be explained when necessary.
- (d) The standpoint of the author should always be given, if it can be easily ascertained. This is a very important matter, especially in subjects on which authors take sides, or represent particular theories.
- (e) The contents of collected works should be adequately set out, and this rule should apply to single-volume editions of poets. Works like Scott's "Lady of the Lake," Shelley's "Prometheus Unbound," Byron's "Childe Harold," etc., which were all issued separately originally, should be noted in the catalogue entry. The same rule applies to volumes of essays, etc. But only important single works should be noted. Not sonnets, songs, etc. The items in such set-out notes, and all notes should be fully indexed.

EXAMPLES ILLUSTRATING RULE e:—

James, Henry. A Little tour in France. With 94 illustrations by Joseph Pennell. 1900.

Rambles, chiefly in the West and South of France, by two Americans, in 1882. Tours, Blois, Bourges, Toulouse, Nîmes, Tarascon, Avignon, Dijon, etc.

Lee, Guy Carleton. Leading documents of English History together with illustrative material from contemporary writers and a bibliography of sources. 1900.

Collection of charters, statutes, declarations, proclamations, and extracts, dealing with the British Empire from 400 B.C. to 1884 A.D. With bibliographical and critical notes. An American work.

Pringle, Thomas. Poetical works. With a sketch of his life, by Leitch Ritchie. 1838, *port.*

Contains "African sketches," sonnets, "Ephemerides," songs, etc. South African poet and anti-slavery advocate, 1789-1834.

5. The index to a classified catalogue should consist of two parts, the author and the subject index. They can be amalgamated like the ordinary dictionary catalogue, but there are advantages in keeping them separate. In the author index the entries should be of the briefest possible kind, compatible with clearness. A mere page or class reference is not enough for the reader who wishes to ascertain what works the library has by a given author. To this kind of reader a reference like the following—

Huxley (T. H.), A, A12, A24, A30, A46,
imposes the burden of separately turning up each entry. There is no real economy in such an index, especially to the user. A better form is as follows:—

Huxley (T. H.), Biology, A24.
 " " Darwiniana, A12.
 " " Evolution and ethics, A12.
 " " Man's place in nature, A30.
 " " Organic nature, A12.
 " " Physiology, A46.
 " " Scientific memoirs, A.

This may swell the index a little, but as it is composed of single-work authors mainly, and will be printed in long, cheap columns, the additional cost will be insignificant. Of course, this method applies to printed indexes only. Pseudonyms are to be referred from in this index. The subject and title index should comprise in one alphabet entries of every subject referred to in titles or notes, and should index the set-out contents of essays, poems, etc. Where references are to notes and works not on the subject heading the index should show them by giving the class and author's name as follows:—

Climate A300; A Brown, A226 Croll, A292 Croll,
B478.

Titles of anonymous works should be noted under their

Sec. 331] CATALOGUING RULES AND METHODS.

first words, as mentioned in Rule 2. The titles of works which are of a striking or well-known character, and do not include a subject word, may be indexed—

Eothen, Kinglake F86.

Mummies and Moslems, Warner F104.

Such titles as the following, which are already sufficiently indexed under their subject words, should never be indexed:—

Egypt in the 19th century.

Timbuctoo, Dubois.

Island of Cuba.

History of Spain.

Naturalist in Nicaragua.

6. For all other matters affecting author entries, Cutter's *Rules* (Section 328, No. 1), compared and balanced with Quinn's *Manual* (Section 328, No. 2), should be used. For any other point not previously included referring to subject or class entries, use the Library Association Rules as revised (Section 328, No. 3).

331. REFERENCE LIST OF AUTHORITIES:—

GENERAL AND RULES.

- Outler, M. S. Bibliography of catalogue rules. In Dewey's "Library School Card Catalog Rules," 1892.
- Edmond, J. P. Cataloguing of fifteenth century books. L. A. R., v. 1, p. 297.
- Graessel, A. Cataloguing. See his "Bibliothekslehre," 1902.
- Guppy, H. Cataloguing of anonymous literature. L. A. R., v. 3, p. 298.
- Lane, W. C. Cataloguing. (Rules, Cards, Printed, etc.) U. S. Educ. Rept., 1892-1893, v. 1, p. 835.
- Quinn, J. H. Library cataloguing. Greenwood's Year Book, 1900, p. 87.
- Stephens, J. A. How to catalogue a novel by its title. L. A. R., v. 1, p. 482.

ALPHABETICAL versus CLASSIFIED FORMS.

- Barrett, F. T. Alphabetical and classified forms of catalogues compared. Int. Con., 1897, p. 67.
- Brown, J. D. Classified libraries and catalogues. See his "Manual of Classification," p. 83.

- Brown-Jast. *Compilation of Class Lists.* L., v. 9, p. 45.
 Doubleday, W. E. *Class lists or dictionary catalogues?* L., v. 9, p. 179.
 Jast, L. S. *The Class List.* L., v. 9, p. 41.
 Jast, L. S. *Classified and annotated cataloguing, suggestions and rules.*
 L. W., 1899, p. 159, etc.
 Pollard, A. W. *Meditation on directories (alphabetical and classified
 cataloguing).* L., N. S., v. 2, p. 82.
 Willcock, W. J. *Classed catalogues and their indexes.* L. W., v. 3, p. 261.

ANNOTATIONS.

- Annotation of historical books. L. W., 1901, p. 183.
 Appraisal or Description? L. W., 1902, p. 264.
 Baker, E. A. *Book Annotation in America.* L. W., 1902.
 Book Annotation Discussion. Lib. J., 1898, Conf. no., p. 15.
 Brown, J. D. *Descriptive cataloguing.* L., N. S., v. 2, p. 135.
 Classification and Annotation of Fiction, by E. A. Baker, J. D. Brown, L.
 S. Jast and H. Bond. L. W., v. 1, pp. 198, 216; vol. 2, pp. 150, 177, 206,
 239.
 Iles, George. *The appraisal of literature (annotations).* Lib. J., 1896,
 Conf. no., p. 26.
 Iles, G. *Appraisal of literature.* Int. Con., 1897, p. 166.
 Iles, G. *Expert annotation of book titles.* U. S. Educ. Rept., 1892-1893,
 v. 1, p. 994.
 Iles, George. *Evaluation of literature.* Lib. J., 1892, Conf. no., p. 18.

BULLETINS OR MAGAZINES.

- Jast, L. S. *Problem of the printed catalogue, with a possible solution.*
 (Bulletins and class lists.) L., N. S., v. 2, p. 141.
 Library Bulletins, by Moulton, Foster and Blanchard. Lib. J., 1899,
 pp. 473-476.
 Library Papers (Bulletins). *Symposium by American librarians.* Lib. J.,
 1892, p. 48.
 Periodical library bulletins. *Symposium by American librarians.* Lib.
 J., 1894, Conf. no., pp. 50-55.
 Savage, E. A. *Reading lists.* L. W., v. 2, p. 259.
 Turner, F. *Bulletins.* L., v. 10, p. 58.

For list of abbreviations see Section 88.

CHAPTER XXII.

PRINTED CATALOGUES.

332. As stated in Chapter XXI., we think that for public library purposes a printed catalogue in dictionary form is inferior in most respects to one in the form of class lists with annotations. The question of cost is such an important one, that on this alone the matter should be decided in favour of the more economical class list. A thousand books catalogued on the dictionary system will occupy from one-half to one-third more space than the same number catalogued in class-list form, according to the degree of fulness with which the work is done, and cost a correspondingly large amount. But apart from the question of class lists on systematic lines, they are much more satisfactory than unwieldy dictionary catalogues, because they show much more clearly the class relationships of books and topics, and by their form give more frequent opportunities for revision. Again, the mere fact that a classified catalogue is less laborious to compile than a dictionary one, though the work may require more intelligence, is another reason for adopting the more scientific form. The reason why there is less labour to be bestowed upon the compilation of a class list, arises from the fact that a considerable part of the work is done in the preliminary classification of the books on systematic lines. Indeed, it may be said that a well-classified library is more than half catalogued. One more consideration, and we have done with the dictionary catalogue. While a classified catalogue is closely connected with the arrangement of classes and topics on the shelves, a dictionary catalogue resembles the higgledy-piggledy confusion which exists on the shelves of an unclassified library, by giving an alphabetical jumble of all kinds of unrelated sub-

jects and authors, which, though quite legitimate in an index, is quite out of place in the catalogue of a semi-educational institution like a municipal library.

333. **Class Lists.**—A considerable number of British and American public libraries are now printing sectional class lists or guides, in place of single alphabetical or other catalogues of the whole collection. The reasons are not far to seek. Systematic classification is making such progress, that catalogues no longer require to be mere guides to numerical shelf arrangements, while the traditional notion that an author list was the beginning and end of everything has been almost completely exploded. As subjects and titles are the chief circumstances connected with books which most people remember, the author list becomes a mere secondary matter. Then again, as most titles are but a repetition of their subjects—*History of Ireland, Elements of Astronomy, Introduction to Theology, Essays on the English Language, etc.*—the title index assumes quite a subordinate value, confined generally to fanciful titles like *Eothen, Ivanhoe, Hudibras, Eikon Basilike, etc.*, which do not clearly convey the subject-matter. These two classes of entries, which occupy such an important and conspicuous place in the make-up of a dictionary catalogue, may be relegated in a systematic class list to the brief index columns, which occupy but a comparatively small space. There are several kinds of class lists published, such as plain author-alphabetical lists of main classes like History, Travel, Fiction, Science, etc., and lists of similar main classes in dictionary form, or the usual alphabetical jumble of authors, subjects and titles. These we do not intend to notice as their day and place in modern library economy have gone.

334. A modern class list is usually confined to one or two closely related classes, and the entries are all made under a systematic progression of numbered topics. The entries are made very full, and all obscure book-titles are annotated and the information given on them supplemented by additional particulars necessary for fully explaining the purpose and scope of every book. In Section 330 are given certain rules for

their compilation. The make-up of a class list may be as follows :—

Title and preface.

Scheme of classification (Sections 313-316).

Author index, briefly in columns (Section 330(5)).

Subject and title index in columns (Section 330(5)).

Body of list in main classes.

Some librarians prefer to issue their lists in small groups of classes, others in large groups. Some issue single class lists and a few issue complete classified catalogues in one volume. This is a matter which must be determined by the size and circumstances of each library, and the size of each class. If the library is not large enough to require separate lists for every class, the following will be found convenient groupings :—

| | Adjustable. | Decimal. | Expansive. |
|--|-------------|--------------------|--------------------|
| Science and Arts - - - | A-B-C | 5, 6, 7 | L-Q, Q-Z |
| History and Biography - - | F-G | 9 | E-G |
| Fiction and Poetry (or Fiction alone) - - - - | K-J | 8 (part) | Y-Yf (part) |
| Miscellaneous (or Poetry with Fiction) - - - - | D-E-H-J-L | 0-1-2-3-4-8 (part) | A-B-C-D-H Y (part) |
| or | | | |
| Religion and Social Science - | D-E | 1-2-3 | B-C-D-H |
| Miscellaneous - - - | H-J-L | 0-4-8 (part) | A-Y (part) |

In most respects four class lists will be found ample in the majority of British municipal libraries : (1) Science and Arts ; (2) History and Biography ; (3) Fiction and Poetry ; (4) Miscellaneous.

335. In compiling class lists or guides care should be taken not only to make every book explain itself by means of notes, but where there are large representations of subjects, or groups of related subjects, such as the history of various countries, it is useful to give a chronological list of the writers as an aid to the actual list itself,

e.g.—INDEX TO GENERAL HISTORIES OF BRITAIN.

Earliest times to end of 16th century.

| | | |
|--------|----------|------------|
| Green. | Lingard. | Sanderson. |
| Hume. | Oman. | Trail. |

This should be prefixed to or added at the end of the entries under the subject-heading itself. Sometimes a very large number of books may be in a library on some particular local or other topic, and the author-list under the heading may include books on a wide range of subjects. For example, at F742 LONDON there will be books on the churches, parishes, theatres, streets, antiquities, tower, life and history of London, to which the author entries would be no ready guide. It is well, therefore, in such cases to add a little small-type topical index at the end :—

e.g.—INDEX TO BOOKS ON LONDON.

Bartholomew Fair—Morley.
Chelsea—L'Estrange, Martin.
Clubs—Timbs.

Histories—Besant, Doran, Loftie,
Stow, Thornbury.
Poor—Beames, Booth, Greenwood,
Mayhew.

There are other sections in which these useful aids can be utilised, such as at individual biography, where references to scattered essays in different books can be added to the works on the biography of the person noticed. If a library has six biographies of Shakespeare, these will be much enhanced, and the whole value of the entries improved, if all the essays on Shakespeare, critical or otherwise, are assembled at the same place.

336. *Bulletins or Library Magazines.*—Since about 1894 a considerable number of British municipal libraries have issued quarterly, bi-monthly or monthly magazines or bulletins, in which are printed lists of new books, notes on the work of the library, notes on the history or archæology of the district, portraits, museum notes, etc. All of these are not of equal value to their readers, and it may be said generally that in most cases where the literary side is cultivated it is at the expense of the practical side. The first use of a magazine of this kind is to supply readers with a regular supplementary catalogue of all additions to the library ; a second purpose is to publish notifications of new rules or alterations in the working of the library ; and a third may be to issue information about the work accomplished by the library. All other matter is purely subsidiary to these departments, and should not be forced into the leading

place. More space should be allotted in these bulletins to the description of new books, and annotations should be very liberally supplied to the entries requiring them.

337. The cost of a magazine on the lines indicated need not exceed £12 to £20 per annum if issued quarterly and kept within reasonable limits, and of this amount a part will be recovered from sales. In some very busy libraries the whole outlay may even be recovered in this way. While effecting a considerable saving over the plan of issuing occasional lists of additions, the quarterly guide or bulletin furnishes a *regular* and continuous catalogue of the accessions to a library in every department, while it also provides printed entries by means of which the card or slip catalogue can be kept up-to-date in the most effective manner. By having a few copies of the bulletin printed on thin paper, one side only, a means is afforded of effecting the purpose of continually revising the card catalogue. The entries can be cut up and mounted on cards or slips, and inserted in the standard catalogue of the library, whatever form it may take. There are other ways in which these magazines can be used to facilitate the work of a library, but most of them will be sufficiently obvious to call for no further remark. The following examples from different magazines will give an idea of their plan and appearance :—

DESCRIPTION.

EUROPE.

Browning, H. E. A Girl's Wanderings in Hungary.

Il. 1 *mp.* '96. CST¹ T43

"Miss B. has certainly the gift of word painting, and her intense love of the picturesque country and the beautiful Magyar people helps to make her descriptions of them very life like. No one can read it without having a complete picture of the country and the people before his eye."—*Literary World.*

Demolins, Edmond. Anglo-Saxon Superiority : To What

Is It Due? (A quoi tient la Supériorité des Anglo-Saxons.) Tr. L. B. Lavigne. *Mp.* CST T42

"The author makes a careful and intelligent comparison between Anglo-Saxons on the one hand, and Frenchmen and Germans

¹C = Central, S = South Norwood, T = Thornton Heath, being the libraries possessing copies.

on the other. The conclusion he arrives at is that the Anglo-Saxons of Great Britain and America are so educated and brought up as to be better equipped for the battle of life than Frenchmen and Germans. The secret of Anglo-Saxon superiority is the fact that Anglo-Saxon peoples belong not to the communistic formation, but to the particularistic formation."—*Literary World*.

Dewar, G. A. B. *Wild Life in Hampshire Highlands.*

Il. (2 col.) '99. *Haddon Hall Lib.* CS 142-2

"Bird-lovers, entomologists, sportsmen—all who feel and delight in the million and one charms of the country, will find something to please them in Mr. D.'s volume."—*Literary World*.

Gould, S. Baring. *Book of the West. Il.* '99. CS 142-3

V. 1. Devon. V. 2. Cornwall.

"The v. are not guide books; they are not histories; they are just entertaining miscellanies on all manner of things pertaining to life and tradition in Devon and Cornwall."—*Literary World*. Many of the c. have references at end on books to be consulted.

Class K.—Prose Fiction.

| | | | | |
|--|---|---|---|-------|
| Barr (Robert) <i>Countess Tekla</i> | - | - | - | 12441 |
| Romance of mediæval Germany in time of Rudolph of Hapsburg. | | | | |
| Boothby (Guy) <i>Pharos. ill.</i> | - | - | - | 12503 |
| Re-incarnation of an Egyptian magician of the time of Pharaoh. Hypnotism. The Plague. Chiefly England and Egypt, present-time. | | | | |
| Cambridge (Ada) <i>Materfamilias</i> | - | - | - | 12407 |
| Tale of Australian life. | | | | |
| Carleton (Wm.) <i>The Black Prophet, a tale of the Irish famine of 1846-47. ill.</i> | - | - | - | 12490 |
| First published 1847. | | | | |
| Chambers (R. W.) <i>Ashes of Empire</i> | - | - | - | 12423 |
| Adventures of American war-correspondents in Paris during the Siege and the Commune of 1870-71. | | | | |
| Cobban (J. M.) <i>Pursued by the Law</i> | - | - | - | 12489 |
| London, Lancashire. Tale of an inventor falsely charged with murder. | | | | |

338. Co-operative Cataloguing.—An attempt to do this work of cataloguing and annotation for non-fictional works on a general scale was made by the *Library World* in 1901, but had to be abandoned chiefly owing to want of support from book-p publishers. This scheme provided for exhibiting as well as classifying and cataloguing the books, and is well worthy of being placed on record in this place. We shall accordingly

reprint the explanatory page attached to each monthly list, and add a few specimens of the style of entries provided.

339. MONTHLY LIST OF NEW BOOKS.

SELECTED, CLASSIFIED, CATALOGUED & ANNOTATED FOR THE USE OF LIBRARIANS & BOOK-BUYERS.

Objects.—To provide a list of non-fictional books, as published, for the use of Librarians and Book-buyers generally, arranged so as to serve as a continuous catalogue of new books; an aid to exact classification and annotation; and a select list of new books proposed to be purchased. Novels, school books, ordinary reprints and strictly official publications will not be included in the meantime.

Classification.—The books are classified according to the *Adjustable System* (English) and *Decimal System* (American), the marks of the former appearing at the left, and the latter at the right side of entries in bold type at the foot of the notes.

Annotations.—Notes are added in every case where necessary, to give information as to the scope and contents of the books. Prices and publishers' names, with other particulars, are also given. The notes are descriptive and not critical.

Exhibition of Books.—The books will remain on exhibition at the rooms of the *Library Supply Co., 181 Queen Victoria Street, London, E.C.*, for two months from the date of the "LIBRARY WORLD" in which they are described. Librarians or Book-buyers are at liberty to call and examine these books at the above address.

Method of Use.—The lists as published in the "LIBRARY WORLD" may be used as suggestions of new books for library committees, and as aids to classification and cataloguing. They may also be obtained in a separate form, printed on sheets of thin paper, on one side only, suitable for mounting on cards, guard books, or slip books, to form catalogues of accessions. It is only necessary, when these slips are mounted, to mark out the classification number not required, and add the accession number of the library at any place thought best, to have a fairly perfect printed catalogue. If several copies of these sheet lists are procured, a subject catalogue can easily be compiled by writing the subject word in bold letters at the top of the entry at any point considered suitable. The following specimen entry shows how this can be done:—

Antarctic Regions.

6894.

Fricke, Karl. *The Antarctic Regions. ill. maps.*
xii. + 292 pp. 1900. Sonnenschein 7s. 6d.

History of South Polar exploration and discovery from the earliest to the present time. Surface and geological structure; climate; ice; fauna and flora. List of books, maps, etc.

F1354

999

The original printed entry, plus the accession number, will serve for the author entry, while the class heading provided will be a guide to the arrangement, if it is proposed to keep the catalogue in classified form. It is also a very useful thing to paste one of these descriptive notes in the book itself as a guide to the reader. The subscription price of these slips is—for one complete copy of twelve sets 4s. per annum; two copies 6s.; three copies 8s.; four copies 10s.

Abbreviations.—Col. = coloured; Fo. = folio; Ill. = illustrated; N.D. = no date of publication; Pp. = pages; Port. = portrait. When no place of publication is given, London is to be understood.

B—USEFUL ARTS.

Blount, Bertram. Practical Electro-chemistry. *ill.*, xii. + 374 pp. 1901. Constable, 15s. *net.*

Metal refining and deposition by means of electricity Electro-plating. Account of processes which have already been, or are likely to be, turned to industrial use.

B238

537-85

Gardens old and new; the country house and its garden environment. Country Life Library. *ill.*, xxiv. + 296 pp. n.d. [1900]. Newnes, 42s. *net.*

Photographs and descriptions of the gardens and buildings of famous English mansions, like Alton Towers, Blickling, Broughton, Chatsworth, Clevedon Court, Condover, Elvaston, Fountains, Guy's Cliff, Ham House, Hardwick Hall, Ightham Mote, Levens Hall, Newstead, Trentham, etc.

B52

710

Hazen, Allen. Filtration of public water supplies. *ill.*, xii. + 321 pp. 1900. Wiley, 12s. 6d. *net.*

Has an annotated bibliography, and several appendices on the water supply of European cities, including London.

B92

628-16

James, T. M. Longman's complete course of Needlework, knitting and cutting-out. *ill.*, xvi. + 452 pp. 1901.

Longmans, 6s.

This book does not include dressmaking, but gives instructions for mending and cutting-out underclothing. Adapted for courses of instruction in schools.

B500

646

Lawler, James J. Modern plumbing, steam and hot-water heating. *ill.*, 397 pp. New York, 1901.

Lockwood, 21s. *net.*

American work, consisting largely of practical detailed drawings and plain descriptions.

B74

796

Nisbet, John. Our Forests and woodlands. *ill.*, x. + 340 pp.
1900. Haddon Hall Library. Dent, 7s. 6d.

A not very technical account of the science of forestry. The author pleads for a more intelligent care of our woodlands.

B56

634-9

340. A somewhat similar scheme for co-operative cataloguing was elaborated in the United States by a committee of the American Library Association, but had to be abandoned for lack of support. It was intended to provide printed cards, ready for use, of all new books, at a subscription of so much per card, or hundred cards, which could be incorporated into any existing card catalogue, and so maintain it in an up-to-date condition, without troubling the library staff to make fresh cards for every new book. This scheme was not carried out by its original promoters, but a method of issuing printed catalogue cards for new books has been successfully started by the Library of Congress at Washington. The British attempt at co-operation had a six months' trial, but when it was found that publishers evidently preferred to stick to their accustomed routine of sending books out for review only to a selected lot of journals, in some of which they are dismissed in a couple of lines, the plan had to be given up.

341. Another method of publishing lists of books added to libraries which has been adopted in a number of places is to obtain the co-operation of the local press in printing occasional lists of new books. This can usually always be done in the smaller towns, but rarely in places where there is great pressure upon the space at the command of newspapers.

342. **Printing Specifications.**—A useful form is given for this in Quinn's *Manual of Library Cataloguing*, but it is chiefly intended for catalogues in dictionary form. The best way to obtain estimates for printing class lists or classified catalogues is to have specimen pages printed of the body of the catalogue and the index, exactly as they are required, and spaced out with the exact number of lines per page.] If the manuscript copy is not ready, estimates can be obtained from the printers per page, according to the specimen pages, and this is a very fair way of

tendering. If the copy is ready estimates should be obtained for the whole job, including covers, in the style of the specimen pages. A printer can soon tell how much print a manuscript will run to, especially if the copy has been prepared in a uniform manner, with ten or twelve slips mounted on the folio. Information on the preparation of catalogue copy for the printer will be found in Quinn's *Manual* and the *Library World* (vol. i., p. 64).

343. REFERENCE LIST OF AUTHORITIES:—

- Andrews, C. W. Printed card catalogues. Int. Con., 1897, p. 126.
Central card cataloguing. (Proposal to send out printed cards for new books from a central bureau.) Lib. J., 1898, p. 508.
Dewey, M. Printed catalogue cards from a central bureau. L., N. S., v. 2, p. 180.

For list of abbreviations see Section 88.

CHAPTER XXIII.

MECHANICAL METHODS OF DISPLAYING CATALOGUES.

344. There are five chief methods of displaying manuscript and printed catalogues which merit attention, and each of these is represented by several variations of the same principle. It is needless to attempt to describe every device which has been introduced for the purpose of displaying catalogues and providing for additions and expansion, and we shall limit our selection to those which are best known, most effective or most used. The five chief methods are the Page, Card, Sheaf, Placard and Panoramic, a nomenclature suggested in an article which appeared in 1893,¹ and since widely adopted.

345. Page Catalogues.—The most elementary form of the page catalogue is the ordinary manuscript book, with stepped thumb index or simple alphabetical division of the leaves, so many being allowed for each letter of the alphabet. This is an unsuitable variety for a public library, and should not be used for cataloguing purposes.

The British Museum public catalogue consists of large guard books, in which printed or manuscript slips of book entries are mounted on the tough cartridge paper leaves, so as to leave space for additions. When a page becomes congested, the slips can be lifted by means of a paper-knife, as they are secured only at the ends, another leaf can be inserted on the adjoining guard, and the old and additional slips can be redistributed over the whole of the newly created space. This catalogue represents but one alphabet, or copy of the catalogue, in some hundreds of volumes, and each volume only holds a small

¹ *Library*, 1894, pp. 45-66, article on "Mechanical Methods of Displaying Catalogues and Indexes," by J. D. Brown.

portion of the alphabet, as from Bal to Bec. One copy of the catalogue thus serves many readers at one time. By distributing the entries over a number of volumes, congestion is less likely to occur than in catalogues complete in themselves in one or two volumes.



FIG. 112.—Section of Catalogue Shelves, British Museum (Section 345).

A variation of this system of guard book is to be seen in some public libraries where the whole of the catalogue is mounted in one volume. A number of copies of this style of page catalogue must be provided to meet public needs, and it is, on the whole, a less serviceable and much more expensive form than the catalogue on similar lines spread over a number of

Sec. 347] METHODS OF DISPLAYING CATALOGUES.

volumes. A good example of this kind of page catalogue is to be seen in the Mitchell Library, Glasgow, where it exists in the form of huge guard books displayed on special stands.

346. To overcome the difficulty of inserting additional leaves at pleasure in page catalogues, various kinds of adjustable albums, with movable leaves, have been introduced. At the Bibliothèque Nationale, in Paris, and elsewhere a catalogue is used consisting of thick, hinged leaves, punched at the back and laced into the boards, or secured by means of a screw fastening.

347. Another variety of this French binder designed to secure adjustability of leaves is that shown below in the illustration (No. 113), wherein the leaves are clamped by the pressure of two wooden slats, which are drawn together by means of two or more endless screws turned by a key.

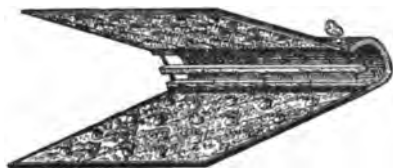

FIG. 113.—Adjustable Screw Binder (Section 347).

For this kind of binder it is necessary to notch the leaves to correspond to the screws.

The principle of the sheaf binders (Section 358) can also be applied to page catalogues, and very successful page books have been made up from the form illustrated in Section 363.

The whole of the devices just described are so arranged that leaves can be inserted, to a more or less limited extent, at any point. The British Museum type does not provide for unlimited additions, nor for any subsequent division of volumes, without much trouble and rebinding. The French and other adjustable leaved binders do allow for unlimited insertions, subject to the condition that the matter mounted on the pages must be re-distributed. In an adjustable book new leaves can be inserted at any place till the volume is full, and then the contents may

be divided and two books used, this subdivision and spreading being continued as the entries increase in number.

348. A form of page catalogue combining the powers of inserting new leaves at any point, and moving single entries about without having to paste them down or lift them up, is called the Rudolph Indexer. It consists in its book form of thick cardboard leaves, to which metal flanges are secured, down each margin. Each leaf is provided with a double-hinged fastening, which enables it to be hooked on to any adjoining leaf, so as to form a volume of any desired thickness, to which a pair of covers can be attached. The catalogue entries are written or printed on narrow cards, and these are slipped under



FIG. 114.—Rudolph Indexer Book, Open Pages (Section 348).

the flanges which secure them by either end. The figure (No. 114) above shows at a glance the appearance of this form of page catalogue. Another form of this device is described in Section 365.

349. There are certain advantages claimed for page catalogues which may be enumerated here. The chief is that a large group of entries can be scanned with one sweep of the eye, thereby facilitating the rapid finding of any particular entry. Another is that, being in book form, it is more easily manipulated than other forms of catalogue. Its comparative cheapness is sometimes put forward as an advantage over other forms, particularly cards, but on this point it is not wise to assume cheapness where so much time and labour

Sec. 350] METHODS OF DISPLAYING CATALOGUES.

are necessarily involved. As regards the claim to rapidity in turning up entries because a whole page is exposed at a time, we have considerable doubts as to its soundness. Our own experience of such catalogues as the British Museum is that, owing to the number of entries, the occasional congestions and disorders where double columns of entries exist, it is much more difficult to find a given entry than in the case of cards or slips properly guided and in accurate alphabetical order. This point may be further illustrated by the case of men or women who are not adepts at using alphabetical lists, and who turn up a particular word in a dictionary with much difficulty and loss of time.

350. Card Catalogues.—Cards for indexing purposes have been used for many years, and are not an American invention, as is generally, but very erroneously, assumed. Because card indexes have been more widely adopted for business purposes in the United States, on a recognised system, with all kinds of guides, safeguards and other accessories, it has been the custom to give the full credit for this form of catalogue to the Americans. As a matter of fact, cards for library cataloguing purposes were used in France in the middle of the eighteenth century; they were used in Trinity College, Dublin, early in the nineteenth century; and in 1852 they were introduced into the Bank of England for commercial indexing. The plan of keeping cards or slips on edge in boxes or drawers loosely, thereby giving unlimited means of expansion and intercalation, must have occurred to many minds as the best means of maintaining perpetual alphabetical order. Single cards not attached in any way, save temporarily, possess unlimited powers of movability, and can be arranged in any kind of order when assembled in numbers, because each card can be taken away or moved about, or fresh cards added at any point in a series, without upsetting any adjoining card, or interrupting alphabetical order.

The cards, when arranged in alphabetical order, are separated into small divisions by means of projecting guides, on which are printed subject or author or other words or class numbers, which serve the same purpose as the running catch-words of a diction-

ary, only they are much more effective, because more conspicuous. They are secured by means of a rod which passes through holes punched in the lower part of the cards, and the rod is either locked or screwed into the back or front of the drawer.



FIG. 115.—Card Catalogue Cabinet, with Sliding Extension Runners
(Section 351).

351. The old plan of storing the cards consisted of placing them in the drawers of a cabinet, and marking the contents of each drawer plainly on the outside. The above is an illustration of a card cabinet, showing the usual guides and sliding

Sec. 353] METHODS OF DISPLAYING CATALOGUES.

runners to enable the whole extent of a drawer to be pulled free of the cabinet for purposes of examination.

352. Another form, which is illustrated below (No. 116), has many improvements recently introduced. Among them may be mentioned an adjustable angle-block, for supporting the cards at a suitable angle for easy consultation: this can be screwed up tight at any point in a drawer, so as to retain a smaller or larger number of cards in place; a special form of spring-rod on which the cards are strung or filed, easily removable, but

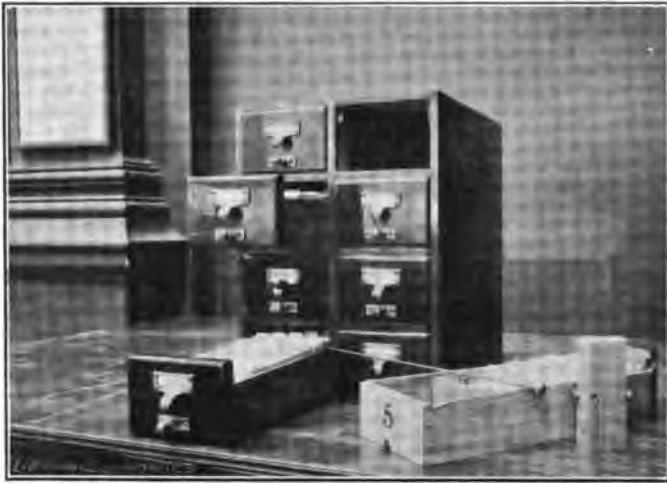
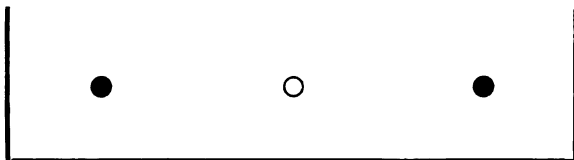

FIG. 116.—Cabinet of Card Trays (Section 352).

still capable of safeguarding the contents of a drawer against misuse by the public; a special automatic catch at the front of the drawer to prevent it being pulled out accidentally, but which does not prevent any drawer from being taken away from the cabinet if required.

353. The card catalogue in cabinets of fixed drawers is not, in our opinion, such an effective arrangement as detachable trays or drawers stored in a suitable rack or cabinet. The fixed-drawer plan has various disadvantages, chief among which

is the serious one that a single person consulting a cabinet may monopolise from 6,000 to 10,000 entries, according to the number of drawers forming a tier. When there are four to six drawers in a tier it is impossible to adjust them so that both tall and short persons will find it equally accessible. The short person cannot examine the upper drawers without standing on tiptoes or a stool, and the tall person must either dislocate his spine, or sit down in order to use the lower drawers. Then, only a few persons can use the catalogue at one time, as two persons will practically cover up three tiers, thus in some cases cutting off from other users at least 20,000 or more entries. There is also the difficulty of filling up application forms for books, as no proper writing surfaces are available. In addition we may mention the difficulty of obtaining a good light on the lower drawers and the large amount of space occupied by a large cabinet. When printed entries are mounted on blank cards, it is advisable to "guard" them, in order to balance the additional thickness of the upper part, which causes bulging, by pricking the fronts of the cards, or embossing them by means of a blunt awl, thus:—



354. For commercial indexing purposes the card cabinet is a useful device, but for public libraries, especially those which are greatly patronised and where a manuscript catalogue in card form has been substituted for a printed catalogue, a more flexible and less rigid system is required. This will be found, so far as cards are concerned, in the various kinds of trays described and figured below. A good form, which is well safeguarded and not too heavy or clumsy, will be found in a tray which is provided with all necessary accessories in the form of locking-rod, guides, adjustable angle-block, outside label-holder, and felt pads to prevent it from scratching table-tops or

Sec. 355] METHODS OF DISPLAYING CATALOGUES.

other furniture. This kind of tray can be kept in racks of a convenient size, and it possesses the advantage of being detachable from the fitting, so that users can remove it to a table and not obstruct other seekers, or be obstructed in turn (Fig. 116, Section 352).

355. A French form of card-catalogue tray was invented by Mr. F. Bonnange, of Paris, in 1866 and improved in 1874. In this, the method of securing the cards differs from the rod threading through perforations, as in English and American

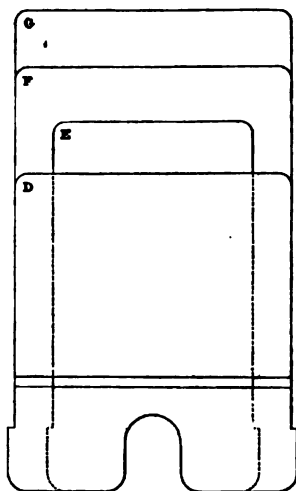

FIG. 117.—Cards for Bonnange Catalogue-Trays (Section 355).

models. The cards are hinged, and have shoulders formed in the slightly thicker lower portion, as shown in the illustration (No. 117), which is also slotted to clear the fastening. The hinged cards shoulder into side grooves formed in the wooden trays, and the slotted portion is placed astride a powerful endless screw, which traverses the tray from end to end, and carries a suitable block which acts as a travelling clamp. The screw is worked by means of a key, and when turned to the right the block travels forward along the screw till the cards are all firmly clamped between it and the end

of the tray; when turned to the left the block travels back and so releases the cards to enable insertions to be made. The upper portion of the cards being hinged and consequently free of the block, are not clamped, and can be turned over readily for purposes of consultation. Guides, alphabetical or numerical, may be inserted either above or at either side of the cards.

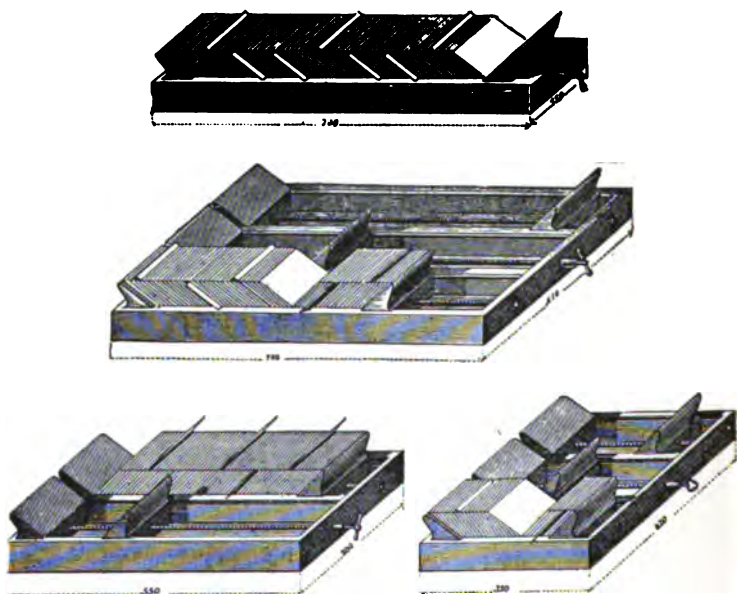

FIG. 118.—Bonnange Card Catalogue Trays (Section 355).

356. An Italian card tray on a somewhat similar principle to this was invented by Mr. A. Staderini, of Rome, in 1890. It differs from the Bonnange tray in having a sliding-block gearing with a ratchet which is fastened along the bottom and made to engage or disengage by means of a key. The cards are similar in principle to those of the Bonnange system, save that the lower hinged half is not slotted. The illustration

Sec. 356] METHODS OF DISPLAYING CATALOGUES.

(No. 119) will explain better than words the appearance and other accessories of this tray.

Both the Bonnange and Staderini methods share in common an advantage of some importance, *viz.*, the clamped lower portion of the card forms a counterfoil to show what has been

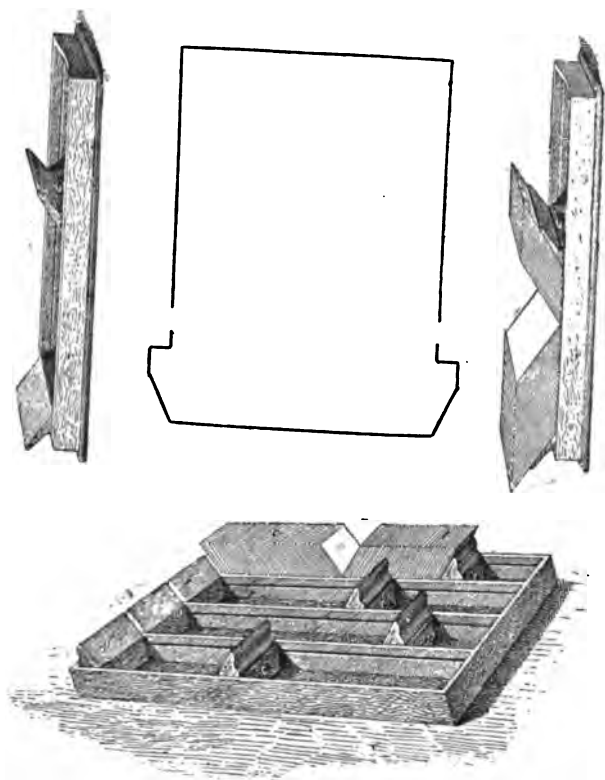

FIG. 119.—Staderini Card Catalogue Trays and Hinged Card (Section 356).

taken, should a card by accident or design be removed or torn off. The accession number or brief title of the book can be written on the clamped portion of the card, and so will safeguard against loss and imperfections. This is an advantage not possessed by any of the ordinary card methods, because

when cards are torn from the rods they leave no trace, and become lost for ever, leaving it very problematical whether a catalogue is perfect or not.

357. A card catalogue on a somewhat similar principle to the French and Italian forms just described is known as the Duplex Card Catalogue, and was invented in England to enable both sides of the cards to be used, thereby considerably enlarging the capacity of the catalogue, while materially reducing its bulk. It is fitted with falling ends which act as angle-blocks; a travelling angle-block which can be adjusted and looked at any point; a locking-rod for threading the cards upon in order to secure them; and xylonite label-holders. The cards are larger than ordinary catalogue cards, and instead of being hinged are simply creased at a short distance above the rod

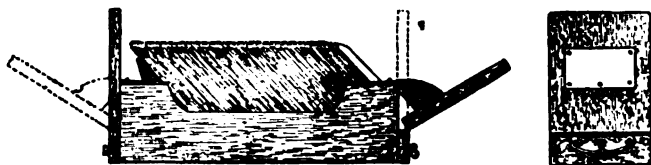

FIG. 120.—Duplex Card Catalogue Tray (Section 257).

holes. This gives a slight bulge and enables the cards to have the necessary play. The trays are held lengthways in a position parallel to the body, instead of at right angles as in the case of ordinary trays, and the cards or leaves are simply turned over like those of a book.

358. Sheaf Catalogues.—The sheaf catalogue is not so widely used as the card system in Britain, but it has exactly the same advantages as regards the power of expansion and intercalation. It aims at combining the advantages of both book and card catalogues, by dividing the catalogue into handy sections so that the maximum number of readers can consult it at one time; providing means for continuous expansion in alphabetical order; safeguarding the contents of sections; reducing the amount of storage space occupied; and enabling users to handle and turn over the catalogue like the leaves

Sec. 360] METHODS OF DISPLAYING CATALOGUES.

of an ordinary book. The introduction of ordinary paper slips, which can be used in any typewriter, which can be easily stored in various forms of binders in book form, and which can be added to in manuscript without undoing the holder, is a real economy in library administration which has not received the attention it deserves. While 1,000 entries in a card catalogue will occupy from 750 to 840 cubic inches of space, the sheaf-holders most in use will not take up more than fifty-six cubic inches of space for the same number of entries. The writing surface is also much larger.

359. The slip catalogue known as the LEYDEN, from its first use in the University Library of Leyden, in Holland, in 1871, consists of bundles of slips, notched as shown in our

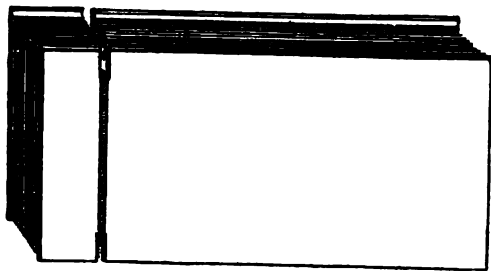

FIG. 121.—Leyden Slip-Holder (Section 359).

illustration (No. 121), and secured by means of cord or catgut. The outer boards are hinged, and notched to correspond with the slips, and the cord is tied firmly round the volume and into the slots, so as to bind the whole. These Leyden holders are only adapted for private or staff use, and must be kept in very thin sections, as the volumes get more loose and insecure the thicker they are made. As a means of holding any kind of temporary slip, this is, however, a useful device.

360. A much more mechanically perfect slip catalogue-holder is the screw-binder invented by Mr. A. Staderini, of Rome. It comprises a fixed back and boards, to which two iron screw-bolts are attached. On these the slips, which are perforated to correspond with the bolts, are threaded, and

the books are secured by means of brass screw-caps which fasten the boards to the bolts, and so make the volume

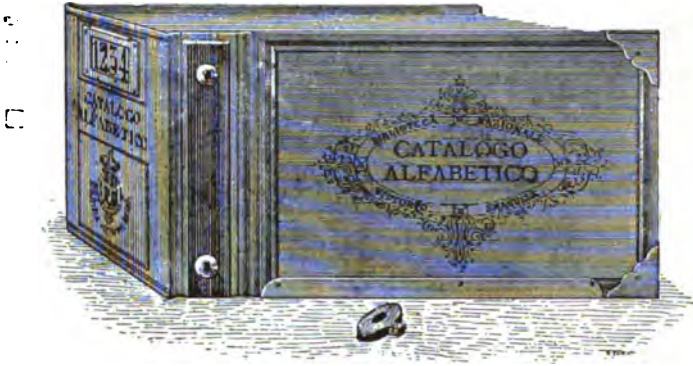

FIG. 122.—Staderini Sheaf Catalogue Volume (Section 360).



FIG. 123.—Staderini Sheaf Catalogue as arranged in the Victor Emanuel Library, Rome (Section 360).

rigid and the slips secure. These volumes are numbered and kept in pigeon-holes, which bear the volume numbers and

Sec. 362] METHODS OF DISPLAYING CATALOGUES.

letters denoting the section of the alphabet contained in each sheaf.

361. A "sheaf"-holder on exactly the same principle, but with a different and neater fastening, was invented in 1891 by Mrs. Sacconi-Ricci, of Florence. This holder also fits into numbered pigeon-holes, and consists of perforated slips threaded on to two upright rods, which are kept in place by means of a sliding bar which, when screwed into place, locks the slips and boards into one compact volume.

362. The most used and oldest of the British sheaf cata-

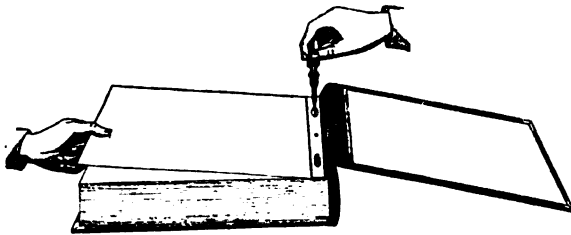

FIG. 124.—Sacconi Sheaf Catalogue, Fastening.



FIG. 125.—Sacconi Sheaf Catalogue, open (Section 361).

logues is the "Adjustable Catalogue-Holder," which was invented about 1892. This has a flexible leather back, and the slips are bound and unbound by the contracting and expanding action of two cylindrical screws, turned by means of a metal key. It is not necessary, as in the case of all other sheaf-holders, to undo this one in order to remove the slips when additions are being made, the loosening of the screws being all that is necessary. The slips are punched at the back edge with bayonet-shaped or keyed slots, which give sufficient holding power when the screws are tightened to

clamp the boards and slips into one solid and firm volume. The book numbers, if written on the clamped portion of the slips, will remain in the sheaf if entries should be wilfully torn out, and no catalogue could be rendered imperfect without the knowledge of the librarian. Xylonite label-holders are attached to the back of this form of sheaf, which enable contents labels to be changed at will, without pasting or damaging the back. A rack or pigeon-holes can be provided in which to store these sheafs in numbered, alphabetical or class order.

363. The most recent form of catalogue sheaf is that

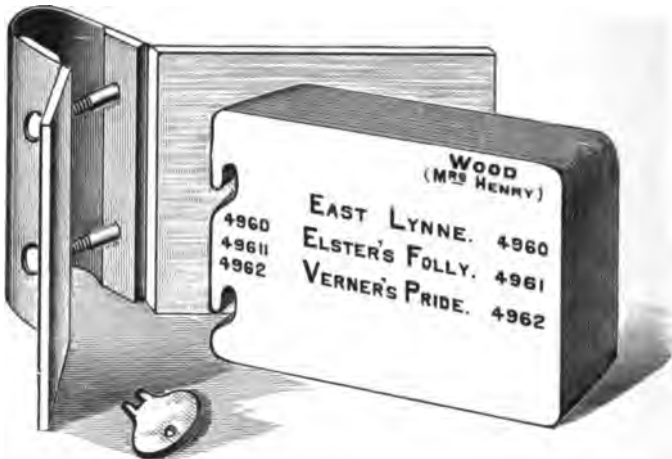

FIG. 126.—Adjustable Sheaf Catalogue, Clamp fastening (Section 362).

illustrated opposite. It differs from the adjustable in having a rigid back, and but one screw. In other respects it is perhaps easier to manipulate than the binders just described.

The holder consists of a strong wooden back to which two stout covers are attached by means of hinges, specially designed to guard against injury to the covers. Within the holder a special form of brass screw-fitting is mounted, upon which the slips are threaded, so that when the covers are closed the whole sheaf is firmly secured by means of a special screw. A few turns of the key suffice to lock or open the holder.

Sec. 364.] METHODS OF DISPLAYING CATALOGUES.

The slips are punched so as to secure absolute uniformity in size and in the position of the holes. The hole being made in an oval form allows the slips to be easily threaded on, or removed from the screw-fitting.

The special construction of the holders prevents the slips



FIG. 127.—Adjustable Sheaf Catalogue, open for Consultation (Section 363).



FIG. 128.—Adjustable Sheaf Catalogue, open for making Additions, with Cradle and Key (Section 363).

from sagging or drooping at their free ends, a fault observable in both the Staderini and Sacconi forms.

364. Placard Catalogues.—The most ordinary form of placard catalogue is a manuscript or printed list of books on a large sheet or sheets, which is framed and hung on the wall where readers can see it. There are several varieties of these

framed lists, which are used chiefly for lists of additions. A form giving the power of moving single entries has been devised in England which is better than anything else we have seen. This consists of a frame with a movable back, on which xylonite slips are fastened in such a way as to form long columns with flanged sides. Under the flanges can be slipped pieces of card-board the width of the columns, which slide up and down in the length of the column as required. The titles of new books can be written on these cards and arranged in any order thought best. By leaving some blank cards between every letter of

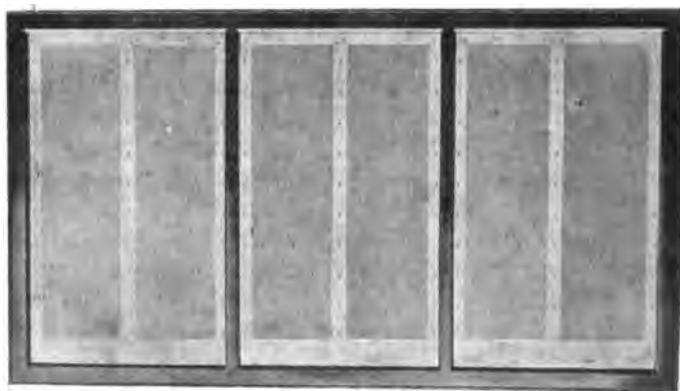

FIG. 129.—Adjustable Placard Catalogue (Section 364).

the alphabet or every class, additional entries can be added at any moment. If several frames are used, some hundreds of new books can be catalogued, and when full the entries can be transferred to the printed bulletin, or otherwise utilised, to free the frames for further additions. The illustration given above will show the nature of this adjustable accessions catalogue, which corresponds in principle with the adjustable Periodical List.

365. Panoramic Catalogues.—Several methods have been proposed or devised for displaying catalogue entries on an endless chain in a panoramic or continuous form, but none of them

Sec. 365] METHODS OF DISPLAYING CATALOGUES.

have been of much practical value, and all are expensive. The most ingenious of this class of catalogue is the Rudolph Continuous Indexer, which consists of a cabinet three feet six inches high, one foot eight inches wide and two feet six inches broad, with a plate-glass top, through which the catalogue can be examined. Inside there are 600 slats or pages, which revolve over two hexagonal drums in a continuous chain, and these are looped up for storage purposes in hanging folds, as shown in the illustration (No. 130), by the very ingenious mechanical



FIG. 130.—Rudolph Continuous Indexer. Method of Automatic Storage (Section 365).



FIG. 131.—Rudolph Continuous Indexer showing Slats or Pages for Consultation (Section 365).

means provided. Each slat has metal flanges at the edges, forming grooves under which cardboard slips bearing the catalogue entries are arranged as desired. The slats are detachable, but provided with uniform means for fastening to any adjoining slats in any position, so that a fresh slat can be inserted anywhere in the chain where congestion occurs. The machine is turned by means of a handle, and works smoothly and without noise. Each slat will hold 136 single-line entries, and the total capacity of a complete cabinet may be put at 40,000 double-line

entries. It is a very serious defect, however, so far as public libraries are concerned, that one person monopolises the whole of the catalogue.

366. REFERENCE LIST OF AUTHORITIES :—

Brown, J. D. Mechanical methods of displaying catalogues and indexes. L., v. 6, p. 45.

Clarke, E. E. Considerations on the card catalogue and library construction. Lib. J., 1892, p. 229.

Green, H. E. Card volumes *versus* card drawers. Lib. J., 1892, p. 5.

Jast, L. S. The sheaf and card catalogues. L. W., 1902, p. 129.

Sacconi-Ricci, G. Observations on the various forms of catalogues used in modern libraries. Lib. J., 1893, p. 423.

For list of abbreviations see Section 88.

CHAPTER XXIV.

INDEXING AND FILING.

367. Indexing.—The principal purposes for which indexing is required in public libraries are in connection with the catalogue, the registration of borrowers, addresses, correspondence and the various books of record, such as minutes, inventories, etc. We have already dealt with catalogue-indexing at Section 330 (5), and the indexing of borrowers is dealt with at Section 430. At this place only the indexing of correspondence, etc., will be considered. Although book-indexing is not a common duty which falls to the librarian's lot, nevertheless a few notes on the subject may be useful, especially in view of the fact that the same principles apply to other kinds of indexing.

368. There is no mechanical system of book-indexing known to us at present; the contrivances sold by stationers being chiefly holders for correspondence or thumb indexers for ledgers and similar business books. The common method of book-indexing is to write the headings or topics on slips, or on long sheets of paper, repeating the headings over and over again, and sorting them alphabetically when the work is finished. It is a terrible task dealing with great masses of little slips, or cutting up and sorting the written sheets, as it practically means handling each item dozens of times and keeping the whole alphabet in mental review. A simple method is as follows: Procure a "stepped" or thumb index-holder of folio size, and place ruled folio sheets in each alphabetical compartment. Most stationers keep several varieties of such cut sheets marked with the letters of the alphabet. If the index is likely to be a very large one, running to over a thousand entries, it will be as well to have sheets marked for all the ordinary alphabetical sub-

divisions—Ab, Ac, Ai, Al, An, Ar, As, Ba, Be, Bi, Bl, Bo, Br, Bu, By, etc. These are to be kept in the index-holder in strict order, and ruled in two columns, the left-hand one to be used for entries, and the right-hand one for additions when congestions occur. The indexing is done by writing each topic with its reference page on the left-hand column of the sheet which is nearest to its alphabetical order, "Black" going on sheet Bl, "Borrow" on sheet Bo, and so on, making due space allowance for third and fourth letters of words, as Bob, Bog, Bom, Bor, etc. The repetition of identical topics is easily prevented by a slight exercise of memory and by glancing over the headings on a sheet before making a fresh entry. The slight loss of time caused by the necessity of turning up a certain sheet before entries can be made is amply repaid in the enormous saving effected in the final revision and sorting. Scarcely any editing is required, and the repetition of topic headings is almost completely avoided; the simple addition of a new page number to an already existing entry being all that is necessary. When the final alphabetisation is undertaken, it is only necessary to cut up, arrange and paste down one sheet at a time. In many cases even this small labour is not required. During compilation it will be found a great advantage having such a rough, but accurate and fairly close, alphabetical arrangement to which reference can easily be made. After trying slips and sheets written in random order as page by page was indexed, we have no hesitation in stating that the method described is the best, quickest and most accurate of the three.

369. There are many methods patent and other of indexing and filing correspondence. We recommend the use of self-indexing alphabetical systems, in preference to separate indexes on cards or slips, for letters. The American plan of numbering letters in a progressive series as received, and then proceeding to make an alphabetical index referring to those arbitrary numbers, is not a method to be approved. This matter is further considered under the head of letter-filing in Section 373. Addresses of all firms having business relations with the library, and persons whose addresses are likely to be wanted, should be

carefully preserved and indexed. For this purpose an ordinary card tray or slip book on the sheaf principle should be used. The chief point to be remembered in connection with the indexing of addresses is that institutions should be indexed under their names and not under those of their officers. An officer is a changeable quantity, while the name of an institution rarely alters. It is well, however, to make a cross-reference from the name of the officer to that of the institution. This rule applies to all government and public offices, and particularly to letter-filing described later on.

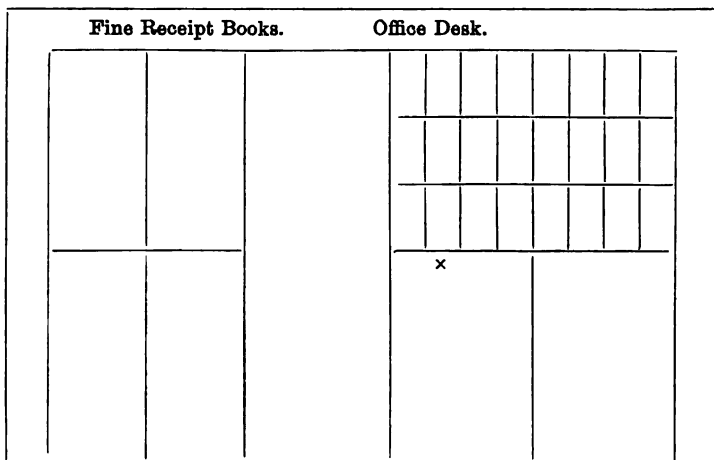

FIG. 182.—Supplies Location Card (Section 370).

370. It is a most important matter, especially in large libraries, to be able to put hands immediately upon any article of stationery or other supplies. The old, haphazard plan of sticking supplies in cupboards with wooden doors, and trusting to luck or memory for finding them again, is too leisurely a method for the busy modern librarian. As a reasonable compromise we suggest that, as a preliminary reform, all storage cupboards or presses should have glazed doors. This simple precaution has the effect of inducing tidiness on the part of the staff, and the prospect of slovenly arrangement is reduced to a minimum. The next process is to decide upon a method of

indexing which will offer the greatest facilities for rapidly finding any given article. In the *Library World* for July, 1899, Mr. Jast, of Croydon, describes a graphic method of achieving this end. He provides a series of cards of uniform size, one or more for each article indexed, according to the need for indexing them more than once in the alphabet. On these cards he draws a rough diagrammatic elevation of the cupboard or other place of storage, as illustrated (No. 132).

On this is indicated at the top left-hand corner the name or nature of the supply, and at the opposite corner its location. When a supply is stored away in this receptacle one of the blank cards representing it is headed as described, and the exact place where the articles are stored is indicated by a cross marked on the diagram, as shown above. Of course, every separate receptacle must have its own series of specially drawn cards. The index is made by arranging these cards in the alphabetical order of the names of the various articles. Any one wanting a new fine receipt book, and not knowing where to find it, would look up this index under the word "Fine" and there he would find the card which indicates not only the receptacle where these books were stored, but also the exact position.

371. A simpler and, perhaps, more straightforward plan would be to mark every cupboard or other receptacle with a letter or number. As these places would have glass doors, if they had any at all, there would be no necessity to mark further separate shelves or pigeon-holes. It is not always possible, or even desirable, to fix the location of supplies beyond the main receptacle. A reference to a cupboard is quite near enough for any one having eyes in his head. To these various receptacles an index on cards or slip books as before can readily be made. The card should bear the name of the article at one of its top corners, and on the opposite corner the number or letter of the place where it is to be found. If necessary the remainder of the card or slip can be used for setting out the dates and quantities of successive orders of the article. This will be found a very useful form of inventory.

372. The indexes of minute books or other manuscript

records should be kept in the books themselves and not separately. A minute book in one place and its index in another constitutes a nuisance of the first magnitude. If a thumb index has not been provided, a few pages, say, twenty-six, may be reserved at the beginning or end of the book, in which an alphabetical sequence can be spaced out in pencil on the lines indicated in Section 368. All indexes of whatever nature—addresses, minutes, supplies, letter books, etc.—should be kept closely up-to-date, and an assistant ought to be made responsible for this important work being regularly and systematically done.

373. Filing.—The same principles which regulate alphabetical indexing should govern the filing of correspondence and other documents. At Section 241 we have described various mechanical filing appliances, and to this reference may be made for suggestions. As regards letters, our previous remarks above apply with full force. The only natural arrangement for letters is an alphabetical one, and no matter what kind of holders are used this arrangement should be invariably followed. A file of letters should be self-indexing, and should not entail the labour and cost of maintaining a separate index of any kind. If it is made the rule to place letters from institutions under the names of such institutions, and to insert, where necessary, in strict alphabetical order slips of paper in 8vo size to hold all cross-references from the names of officers, as may be required, there will be no need for any further name-indexing. If topical indexes are desired they can be compiled on similar 8vo slips, the subject word being written boldly at the top of the sheet, and the names of the writers on the topic entered in rough alphabetical order below. When a topic is remembered and the correspondent's name is forgotten, this enables a reference to be promptly made. These slips can take their place in alphabetical order among the letters. Such a file, stored in boxes similar to those noted in Section 242, with all necessary cross-references, need not be larger in extent than one year's correspondence.

At the end of every year the correspondence boxes can be

emptied and tied up in suitable bundles, preserved in strict order, and endorsed with the year and alphabetical section of letters contained. The use of separate "folders," or stout manila wrappers, of uniform size, for keeping together all the correspondence of one individual, or on one subject, is a very useful adjunct to the method of alphabetical filing just described.

374. If the year's correspondence is not very large, probably half a dozen boxes will contain the whole lot. In such a case cardboard alphabetical divisions—A, B, C, D, etc.—can be made to fit the inside of the boxes, and distributed as required. Where there is a very large annual correspondence, a separate box can be appropriated for each letter of the alphabet, saving such small ones as I, J, O, Q, U, V, X, Y, which may be included in the adjoining letters. Cardboard alphabetical guides marked with minor divisions, such as Ba, Be, Bi, Bl, and so on, can be provided, as with the smaller files. These will serve as guides and help to preserve the alphabetical order. Each box should be clearly lettered outside by means of xylonite label-holders.

375. The guard file described in Section 243 is intended for LETTERS which are kept in alphabetical order with a separate card index. It can also be used for filing such documents as contracts, estimates, specifications, reports, etc. A separate file can be reserved for each class of document, and, when lettered on the back, will be found a useful and convenient plan of keeping much-used documents handy. Documents which require to be folded and endorsed can be kept in one of the forms of clamps mentioned in Section 244.

376. MAPS and PRINTS, when unframed or unmounted, are best kept flat in large cloth-covered boxes with dust-proof lids, suitably labelled outside to indicate the contents. A xylonite label-holder tacked outside will be found a much more effective plan than permanently lettering the contents on the outside. This enables any change to be made. These print- and map-boxes can be placed on racks like those mentioned in Section 188, or stored in a special cabinet. When the collection is small the different

kinds of prints can be kept separated in the boxes by means of large sheets of cartridge paper placed between, and lettered to indicate the class of prints in each division.

377. PAMPHLETS, when not bound in volumes, should be stitched in manila wrappers, and stored in boxes of various sizes, such as 8vo, 4to, etc., of the kind specified in Section 242. Each pamphlet should be lettered on the side of its wrapper, with its author, title, date, class letter and number and accession number. The collection might be commenced with an 8vo box for each class, and gradually extended from this nucleus as the stock increased, the contents of boxes being divided and subdivided, and placed in new boxes with changed lettering. As these would be arranged in class order, there would be no more difficulty in finding a single pamphlet than

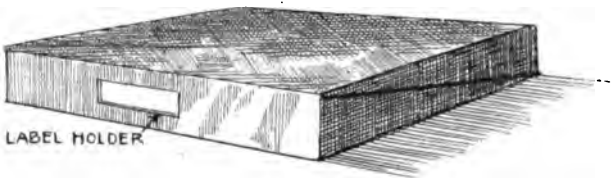

FIG. 138.—Box for Filing Prints (Section 376).

in finding a book. With miscellaneous collections of pamphlets bound in volumes, the best plan is to renumber them in a progressive series, and carry the volume number against the catalogue or other entry. It is not advisable to run more than one series of numbers, and if by chance a collection is acquired which is already numbered, these should be covered over with the continuation numbers of the library's own progressive series.

378. The filing of newspapers and periodicals can be done in a variety of ways. Newspapers should be kept in order on special racks, in piles, with a suitable board underneath to act as a runner and support, and a sheet of cardboard or glazed casing paper above to prevent the settlement of dust. Periodicals and magazines may either be kept in special cloth-covered boxes made to take a whole or half-year's numbers, as the case may

be, or kept on boards in the same style as newspapers. In both cases alphabetical order of titles will be found the most suitable arrangement. The plan of placing the numbers of a periodical as done at the Mitchell Library, Glasgow, seems a very simple and effective manner of dealing with a large number of different files. This is illustrated below:—



FIG. 134.—Periodical File (Section 378).

379. REFERENCE LIST OF AUTHORITIES :—

- Fletcher, W. I. Indexes and indexing. U. S. Educ. Rept., 1892-1893, v. 1, p. 1010.
- Nichols, J. B. Indexing. Lib. J., 1892, p. 406.
- Austin, W. Pamphlets: what to do with them. Lib. J., 1893, p. 143.
- Biscoe, W. S. Pamphlets. U. S. Educ. Rept., 1892-1893, v. 1, p. 826.
- Jast, L. S. The Treatment of Pamphlets. L. W., 1901, p. 60.
- The Treatment of Parliamentary Papers. L. W., 1901, p. 147.
- How to keep unbound maps. Symposium by American librarians. Lib. J., 1891, p. 72.
- Dana, J. C. Rules for the care of photographs. See his "Library Primer," p. 171.
- Bardwell, W. A. Scrapbooks. U. S. Educ. Rept., 1892-1893, v. 1, p. 999.
For list of abbreviations see Section 88.

DIVISION VIII.

MAINTENANCE AND ROUTINE WORK.

CHAPTER XXV.

STATIONERY AND RECORDS.

380. Forms and Blanks.—Most of the important forms and blanks have already been described and figured under the different departments to which they refer, and this section will, therefore, only deal with a few general forms. **NOTEPAPER** of various kinds should be provided, some in the ordinary business size, some post quarto, and some foolscap folio. On each of these sizes the usual heading should be printed, with the arms and name of the town, librarian's name, and any other information thought necessary. All ordinary correspondence can be carried on with the business size, but official and complimentary letters should be written on the larger sizes, especially if a typewriter is used. **ENVELOPES** to suit the various sizes should also be procured, and it is a good plan to stock some large-sized manila envelopes for sending off large documents, reports, etc. These can be had in a variety of sizes, and some of them have clasps instead of gummed flaps, which make them very useful for temporary filing purposes. Gummed postal **WRAPPERS** should also be stocked in a fairly large size, and **LABELS** for sending off parcels, with the name of the library boldly printed on them, will be found very useful.

381. Writing Materials.—**INKS** are manufactured in such a variety of kinds and colours that choice is made difficult. A good black ink should be procured, and also a bright red colour. Copying ink is not really necessary, as ordinary blue-black ink, if not blotted but allowed to dry naturally, will make perfectly good press copies. Care should be taken not to completely dry

the tissue-paper leaves of the letter book when making copies. Other colours of inks, such as green, violet, etc., can be obtained if wanted for special purposes. INK-WELLS should be got in the modern reservoir form, with a constant level dipping place. Ink kept in such receptacles never gets thick or dirty, and the pen is never overcharged or underfed. These ink-wells with rubber tops can be obtained for one shilling each, but for staff and committee use a better variety should be ordered. Ink-wells should always be associated with pen-racks rather than with pen-trays. A rack sorts the pens and pencils out automatically in a visible order, while a tray wastes a frightful amount of time annually, owing to the groping and examining and fruitless fumbings necessitated before the right pen or pencil is found among its fellows. One pen one place, is a good motto for any librarian. Of course the FOUNTAIN PEN removes a great deal of the waste of time and trouble inseparable from ink-pot filling, pen selecting, pen dipping, etc., and every librarian ought to have one as part of his ordinary equipment. There are various sorts in the market, but the higher priced ones are, as a rule, the only reliable ones, and the cost, 8s. 6d. to 10s. 6d., is an investment on which a return is soon made. STYLOGRAPHIC PENS are very useful, but because of their tendency to spoil good handwriting, they are not so satisfactory as fountain pens, although they are much cheaper. For staff use in the numbering of book labels, charging, etc., stylographic pens would be found very useful, and every library of reasonable size should stock a few.

PENCILS for public use should be the ordinary cedar ones at about 3s. 6d. a gross. For note-book copying purposes a Rowney "H" pencil, retailing at twopence, will be found of great value, as it does not "set off" like an ordinary "H-B". A hard pencil lasts much longer than a soft one, it does not require pointing so often, and the fact just mentioned, that writing done by its means does not blur or "set off," is an advantage not to be despised. Red and blue crayon pencils should be kept for checking purposes. Ordinary pen-holders and hard and soft pen-points are occasionally stocked in public libraries, as well

as pencils, to lend out to the readers. Where this is done a certain amount of loss will have to be faced, as pens and pencils both disappear in the most mysterious ways. It is, however, a very great convenience to provide pens, especially in reference libraries fitted with special reading-tables provided with sunk ink-wells.

Blotting paper, foolscap paper ruled faint, scribbling pads, and common white paper in sheets about 15 inches × 9 inches for mounting slips, should be provided among the writing materials of a library.

382. Library Stationery Cabinet.—It is needless to set out in more detail the various desk accessories and miscellaneous stationery required in a library, and we shall simply enumerate the contents of a stationery cabinet, which ought to be had for every library. We believe a cabinet of this sort could be made up in various sizes and prices, like medicine chests, and would be found much more useful than the random method of buying articles at present in vogue.

STATIONERY CABINET.

| | |
|---|--|
| Paper clips. | Scissors. |
| Stationery case. For holding a supply of envelopes, note-paper, etc. (large sizes). | Stickphast. |
| Numbering machine (five figures). | Higgins' library paste. |
| Rubber dating stamps, with loose type and with band-changing apparatus. | Rubber bands, assorted. |
| Rubber printing outfit. | Rubber erasers. |
| Nest of drawers, twelve in cabinet. | Call bells, for public or office use. |
| Cash-box. | Gummed labels, assorted sizes. |
| Paper fasteners, corner clips, wire clips and brass clips. | Sealing wax. |
| Red tape, several spools (for documents only, not for public use!). | Roll of adhesive mending paper. |
| Pins. | Twine of various thicknesses. |
| Hand-rest for writing. | Ruled cross-section or quadrille paper (for planning). |
| Tape measure or good two-foot rule. | Tracing paper. |
| Waste-paper basket. | Case of mathematical instruments. |
| Despatch basket (wicker), for holding documents. | Paper knives. |
| Letter scales, weighing to eight pounds. | Bone folders. |
| | Leather book-carrying straps. |
| | Reading and magnifying glasses. |
| | Key rings and labels. |
| | Writing pads or tablets. |
| | Manuscript books of various sizes, 8vo, 4to, folio, for odd record purposes. |

383. Records.—An inventory should be kept of all supplies ordered, with dates and quantities, and a very good plan is to use the cards described at Section 371. These could be ruled in a series of columns to show dates, quantities and prices, and kept in a box which would serve the double purpose of inventory and supplies index. But there are other supplies besides stationery, etc., and these would have to be added. An inventory book should be kept in which to enter all movable property belonging to the library, such as furniture, pictures and other articles. It could be ruled as follows, and have so many pages set apart for each class of article.

| Date. | Description. | Price. | | | Vendor. | Location. |
|-------|--------------|--------|----|----|---------|-----------|
| | | £ | s. | d. | | |
| | | | | | | |

FIG. 135.—Inventory Book (Section 383).

The Library KEYS should all be assembled on a special keyboard. This should consist of a large board fitted with the necessary number of hooks, one for each key or group of keys, and a proper descriptive label and number should be pasted under each hook. The keys should be numbered and labelled to correspond, with ivory labels attached by rings to every key. In addition an alphabetical list should be fixed to the door of the key-board, so as to facilitate finding. When keys are removed from the building, they should be insured with one of the key insurance or registry offices.

384. Routine Work.—There are several minor matters of routine or arrangement not dealt with in other places. Dusting is usually underdone in British libraries. For one thing there is never a sufficient supply of cloth dusters in any library. Usually a dirty one, stowed away in a drawer, is all the provision for a large library. Clean dusters should be attached by means of rings or clips to every bookcase and cupboard

throughout a library, and the staff should be taught to use them on every possible occasion. There would be much less dust among book-shelves if a liberal supply of dusters were allowed and constantly used. When books are being dusted systematically a large tray or box of wet sawdust should be provided. Into this the books should be dusted by means of a brush.

It is also a good plan, whenever possible, to take very dusty books out to the open air, and smartly beat them together, two at a time. This drives the dust out more effectually than anything else. The mechanical dusting machines which work by means of suction are sometimes useful in cases where large accumulations of dust require to be removed, and not simply redistributed. The floor preparations named at Section 170 are said to be effectual in keeping down dust.

385. REFERENCE LIST OF AUTHORITIES :—

Inks for Library Use. Symposium by American librarians. *Lib. J.*, 1894, pp. 84, 124.

Swan, R. T. Paper and ink. *Lib. J.*, 1895, p. 168.

CHAPTER XXVI.

BOOKBINDING AND REPAIRING.

386. *General.*—Public library binding is an art by itself, and is quite distinct from ordinary commercial bookbinding on the one hand, and artistic binding on the other. A binding which is strong enough to withstand the handling of its owner and his friends, and beautiful enough to please the taste of the fastidious amateur, is practically useless in a position where it may have to endure the handling of hundreds, or even thousands, of different persons, all of whom are not equally educated in the proper use of books. A public library book requires to be bound neatly and strongly, with particular regard to the integrity of the stitching rather than to its mere covering, although this has to be considered in the case of much-used reference books.

387. For public library work it is absolutely necessary to employ only good binders who are experienced in this particular class of bookbinding. In very many cases, especially in small towns, the work turned out by local binders is about as bad as it can well be, and just as likely to lead to the rapid destruction of books as to their preservation. Cheapness does not in this matter necessarily mean economy, nor is good workmanship an invariable accompaniment of low prices. It may be said generally that library binding is one of the items of maintenance which no library can *afford* to have done cheaply and badly. It is much better, in the long run, for a library in a small provincial town to send its work to a recognised bookbinder in a large town, and even to pay carriage both ways, than to depend upon the local bookseller or stationer, who only knows about the casing of magazines. A good binder will bind a book in a manner which will enable the boards to outlive the leaves,

while a poor workman will require to have his work done over again very soon, if, meanwhile, his rough and unscientific methods have not tended to shorten the existence of the book.

388. The question of binding books from the sheets, or re-binding cloth- and paper-board books in leather, before putting them in circulation, has been much debated, though it is really not a very formidable or difficult matter after all. As no one can foretell with any certainty whether or not any given book is going to be popular and much used, it is manifestly a mistake to have any book re-bound, or specially bound from the sheets in leather, until this very important point has been very clearly ascertained. Time alone can determine whether a book is going to be popular, and for this reason we do not think there is any economy or gain in specially binding new books at the outset. Books in publishers' cloth bindings, when printed on paper of fair quality, will often circulate forty, fifty and even seventy times before attaining a condition which requires re-binding, and when strongly and properly re-bound in leather or other boards will outlast the book. Some claims have been advanced with regard to the durability of various styles of binding, but it is impossible to ignore the fact that it is the paper of the book and not the covers of the binding which forms the weak point. Dirt is a much more potent factor than rough usage in shortening the life of a book, and it really matters very little what kind of special materials or stitching are employed, no book's existence can be prolonged beyond a certain term of years, when dirt and inferior paper are such important elements in the matter. There are other important factors in the question of binding from sheets, and one is the difficulty of obtaining the necessary copies from publishers. Another is the fact that some cheap novels cannot be had in quires at all, and, consequently, any advantage which may result from unused sheets giving a better and firmer hold for stitching is in this case completely lost. The value of new books re-bound in special materials has been somewhat exaggerated, and librarians and committees should first adopt the ordinary method of allowing use to determine the books which require re-binding.

389. It would be infinitely more valuable if publishers would issue some copies of every novel by well-known authors, printed on specially tough paper, and bound according to the specification given in Section 397. This would meet every need which exists for specially bound copies of popular books, and give the much more valuable advantage of editions printed on paper which is not mere rubbish.

390. **Home Binding.**—The question of establishing a book-binding plant, for the purpose of conducting binding on the library premises, is one which only affects the large libraries of the country. Comparatively few libraries in Britain have enough of new binding or repairing work in a year to justify the expense of buying appliances and materials, or paying for the necessary expert staff which would be required. On the other hand, very large towns with a number of branch libraries may find it both economical and advantageous to establish binderies, if not for extensive operations in the binding of books, at least for their repair and re-casing. At Portsmouth a complete bindery has been established, wherein all binding and repairing is undertaken, not only for the library, but for the various municipal offices. The cost of this, however, seems to be somewhat in excess of what is paid in other libraries for having the work done outside. In 1899-1900 the Portsmouth Library bound 1,508 volumes; repaired, re-sewed and re-cased 10,319 volumes; made fifty-one reading-cases; and numbered 4,974 books and cards, at a cost of £256 18s. 4d., made up of—

| | | | | | | | |
|-------------------------------|---|---|---|---|-------|----|----|
| Materials | - | - | - | - | £25 | 13 | 2 |
| Binding books | - | - | - | - | 129 | 2 | 10 |
| | | | | | <hr/> | | |
| | | | | | £154 | 16 | 0 |
| Balance, presumably for wages | | | | | 102 | 2 | 4 |
| | | | | | <hr/> | | |
| | | | | | £256 | 18 | 4 |

Nothing is said about light and fuel for this purpose, but it is doubtless included in the sum for binding. Of course, there has to be considered the immense advantage of having this work done on the library premises, under the immediate control

Sec. 392] BOOKBINDING AND REPAIRING.

of the librarian and his staff, while, on the other hand, the difficult task of buying materials and the labour of supervising this branch, with its extra fire risk, must also be taken into account. At Brighton in one year 1,525 volumes were bound and repaired, in addition to minor repairs effected by the staff. In Belfast the total cost of binding only came to £121 4s. 11d., while at Bristol, in the course of twenty-one months, 9,534 volumes were re-bound and repaired, of which 8,459 were done exclusively by the library binding staff. There seems to be a considerable difference between the quantity of work done on the premises at Portsmouth and Bristol, but as no financial statement is given in the Bristol report, it is impossible to make any comparison. In the absence of further and more complete returns based upon actual experience, we are not prepared to advocate home binding save in the very largest libraries. We believe, however, that a joint-stock or co-operative bindery could be worked by the London Metropolitan Borough Libraries with considerable prospects of success and economy.

391. Repairing departments stand upon quite another footing, and here, we believe, there is safe ground for experiment with every prospect of success. At Glasgow and Croydon, and, we believe, other places, small repairing plants have been in operation for some time with good results. At both Glasgow and Croydon women binders are employed, who repair and re-case books, stitch pamphlets in covers, and even bind cheap books which are not likely to be greatly used. Here lettering and numbering are also done, a useful branch of the bookbinders' art, carried on at a considerable number of other libraries. A repairing plant such as is used at Croydon costs about £10, while the wages of a binder may range from 20s. to 25s. weekly. Materials also run in to a certain sum per annum, according to the nature and amount of work done.

392. Finishing, which includes lettering and numbering, can be done by members of the library staff, although instruction is sometimes difficult to obtain owing to trade jealousy and the absurd regulation of most polytechnic schools, which, though supported by public funds, deny instruction to any save

those actually engaged in particular trades. Perhaps the day will come when properly equipped library schools will be established at London, Edinburgh, Dublin and Cardiff for the instruction of librarians, not only in advanced librarianship, but in bookbinding, typography and all allied practical arts. A complete finishing plant, including sets of numbers and alphabets, can be purchased for about £3 3s., and even small libraries can afford this sum, if only to obtain the satisfaction of accomplishing on the premises the work of class lettering and numbering, which requires both care and neatness. At any rate, inquiry should be made by librarians as to the possibilities of establishing a finishing department, especially in cases where a systematic classification is used.

393. Materials.—For public library purposes book-covering materials should be of the most durable sorts, and it is not wise to employ many different varieties either of cloths or leathers. Ordinary binders' cloth is nearly as satisfactory as anything else for preserving its colour, lettering and defying the pernicious effects of gas-laden atmospheres and extremes of temperature. It will not stand much handling, however, and is very liable to wear out at corners. Nevertheless, for little-used collections of pamphlets, sets of local publications, and other matter which merely wants binding for appearance's sake and storage purposes, ordinary binders' cloth is strongly recommended. Smooth varieties are preferable to rough or patterned kinds, as being less liable to harbour dust. Apart from ordinary binders' cloth, the best-known varieties are linen cloths, buckrams and pegamoid and Rixine cloths. Buckrams and linen cloths are expensive in comparison with their durability, and are not recommended save for special purposes. Pegamoid cloth is ordinary binders' cloth treated in a special way with some preparation of celluloid to render it impervious to dirt and moisture. For novels it is perhaps as good a binding as can be obtained, and as it works out at from 10d. to 1s. per volume for full-bound work, it cannot be regarded as expensive. At any rate, experience has proved that this material will outlast any novel which may be re-bound in it, and, after all, that is as much as can be expected of any

binding. It does not carry gilt lettering so nicely as ordinary cloth or leather, and at first gives off rather a strong camphorated smell. It is also apt to become somewhat sticky and clammy to the touch, but, on the other hand, it can be washed !

394. The principal leathers for public library bindings are pig-skin, Persian and Levant moroccos, and roan. Calf, Russia and other fancy leathers should not be used on any account, as they turn brittle under the influence of heated and dry air, and crumble to pieces. Apart from this, they are costly and otherwise unsuitable for public library purposes. The leathers recommended should be used according to the books which they have to cover, and the following list will give an idea of the best classes for which to use each kind :—

Levant morocco, or real morocco, made from goat-skin.

This material should only be used for very valuable books which require a handsome and dignified binding. It is durable, but too expensive for ordinary work.

Persian morocco, made from sheep-skin, is not so dear or so good as Levant morocco, but is a very durable and satisfactory leather if a good quality is procured. It should be used for popular books in the non-fictional classes of the lending department. Ordinary crown octavos, bound in half-Persian morocco, can be had at prices ranging from 1s. 1d. to 1s. 3d. per volume, according to quality of leather and locality. Provincial prices are lower than London ones, as a rule. Heavy books can be bound in this leather, but pig-skin is better.

Roan is a kind of inferior sheep-skin, with a different grain and surface than Persian morocco, and is a useful and cheap leather for certain classes of books, such as the less popular works of travel, science, theology, fiction, etc. Books up to the crown octavo size can be half-bound in this material at prices ranging from 10d. to 1s. a volume. Heavy books are not recommended for binding in this leather.

Pig-skin is the strongest leather of all, and also the most durable ; but librarians should make certain that real pig-

skin is supplied, and not some wretched imitation. The price of pig-skin is rather more than good Persian morocco. It is the best leather to use for heavy books, and all reference works, such as dictionaries, atlases, directories, and other volumes which are being constantly handled.

Other binding materials, such as vellum, parchment, canvas and patent leathers of various kinds, are seldom required in libraries, and need not be considered further. Preparations for spreading on books to protect them may also be passed over, and also the continental and American habit of covering all books in manila or other paper covers of uniform colour. It may be observed, however, that when leather bindings begin to get dry and worn, it will be found an excellent thing to treat them with ordinary vaseline. It should be rubbed well and plentifully into the texture of the leather with the fingers, and when it has soaked in, should be wiped with a soft cloth. Vaseline is as good as any patent or other preservative for reviving decaying and shabby leathers of all kinds. As regards covers the time has not yet come when the individuality of a book, as issued by its publisher, or given by its appropriate library binding, requires to be hidden under a paper mask.

395. Class Colours.—In systematically classified libraries there is a certain amount of advantage to be gained by re-binding each class of books, as required, in some appropriate colour. When open access to the shelves is also granted, there is a very considerable aid to the maintenance of order given by the use of distinctive class colours. Although it is impossible to hope that successive lots of binding will be in exactly the same shades, a fair approximation may be obtained by using the class colours suggested below, in the order given, or any alternative progression:—

| Class. | Colour. | Class. | Colour. |
|------------------|-----------------------|-----------------------|--------------|
| A Science | =Light Brown or Fawn. | F History & Travel | =Dark Green. |
| B Useful Arts | =Grey. | G Biography | =Marone. |
| C Fine Arts | =Orange. | H Philology | =Light Blue. |
| D Social Science | =Light Green. | J Poetry | =Red. |
| E Theology, etc. | =Black. | K {Fiction | =Dark Brown. |
| | | {Juvenile | =Yellow. |
| | | Class L Miscellaneous | =Dark Blue. |

396. **Lettering and Numbering.**—When lettering and numbering have to be done apart from the re-binding, they can be executed by the staff after a little practice, as pointed out in Section 392. The object of lettering is to facilitate the finding of books, and for this reason it should be clear and bold. It is also possible by means of a little variation to obtain a certain amount of class-guiding in the system of lettering, and it should be made an invariable principle in every public library to adopt a certain order of particulars on the backs of books, and stick to the order. Too often this important matter is left to the fitful fancy of the binder's finisher, with the result that very frequently the author's name appears in all the panels in rotation. The following series of suggestions for dealing with each class is offered as a basis on which any librarian can build a system of his own. The letterings are arranged on the principle of guiding readers and assistants as naturally and easily as possible to particular books, and providing for authors, titles, volume numbers, class numbers, and dates of publication when necessary. As indicated in Section 318, we prefer the class letters and numbers to occupy one definite place on each book, which will not be subject to variations in height when appearing on books of different sizes. Another reason for this is that most books in bindings, as issued by publishers, have their titles close up to the top, and so it is rendered impossible in many cases to stamp new figures there, while large paper labels often cover part of the title. The following standard markings for the backs of books are arranged so that authors occupy the leading panel in all classes arranged by authors' names under topics, and titles come first in cases where they are the chief item. Most of the classes lead off with the author's name, but Nos. 8 and 13 are exceptions. The first is a life of W. E. Gladstone, arranged as an item of individual biography under the subject, and further accentuated by having the three first letters of the subject's surname boldly printed as a catch-guide. The second is the title of a magazine, and has no author to come first. No. 5 is dated to show a first edition; No. 10 has the initial of the author's Christian name to distinguish him from other

poetical Morris; No. 11 shows a method of dealing with changed names, and the omission of the class letter from Fiction; No. 12 indicates how juvenile works may be differentiated by using the class letter; and No. 14 shows how edited essays can be dealt with.¹

| Light Brown or Fawn. | Grey. | Orange. |
|-------------------------|------------------------|----------------|
| | | |
| GREEN (J. R.) | GREEN (J. R.) | AUBER |
| MANUAL OF BOTANY. | MANUAL OF BOTANY | FRA DIAVOLO |
| Vol. 1 | Vol. 2 | |
| A 200 | A 200 | C 436 |
| | | |
| | | |
| 1 | 2 | 3 |
| 4 | | |

¹In the *Library World*, vol. iii., Mr. Jast has made certain suggestions for binders' letterings which may be studied with profit.

Sec. 396] BOOKBINDING AND REPAIRING.

Light Green.

| |
|-------------------------|
| |
| |
| |
| |
| SMITH (A.) |
| WEALTH OF NATIONS |
| Vol. 1 |
| |
| D 94 |
| |
| |
| 1776 |

5

Black.

| |
|----------------------------|
| |
| |
| |
| |
| HODGE |
| |
| OUTLINES OF THEOLOGY |
| |
| |
| E 286 |
| |
| |
| |

6

Dark Green.

| |
|-----------|
| S964 |
| |
| |
| |
| WATTS |
| |
| |
| |
| SPAIN |
| |
| |
| |
| F 1216 |
| |
| |
| |

7

Marone.

| |
|-------------------------|
| |
| |
| |
| |
| LIFE OF GLADSTONE |
| |
| |
| |
| SMITH |
| |
| |
| |
| G 88 GLA |
| |
| |
| |

8

Light Blue.

| |
|--------------------|
| |
| |
| TAINE |
| ENGLISH LITERATURE |
| Vol. 1 |
| H 854 |
| |
| |

9

Red.

| |
|-------------|
| |
| |
| MORRIS (W.) |
| POEMS |
| Vol. 1 |
| J 62 MOR |
| |
| |

10

Dark Brown.

| |
|-------------------|
| |
| |
| MAXWELL [BRADDON] |
| VIXEN |
| |
| MAX |
| |
| |

11

Yellow.

| |
|--------------|
| |
| |
| HENTY |
| FACING DEATH |
| |
| K 14 HEN |
| |
| |

12

Dark Blue.

| | |
|---------------------|-----------------|
| | |
| | |
| QUARTERLY REVIEW | BACON |
| JAN.-APR. 1894 | ESSAYS |
| Vol. 178 | WHAATELY Ed. |
| L 6 | L 20 BAC |
| | |
| | 1896 |
| 18 | 14 |

FIG. 196.—Specimens of Class Lettering and Numbering (Section 396).

The chief points to emphasise in these suggested letterings are that the class letter and number should always occupy the same relative position irrespective of the size of the volume, namely, about two inches from the foot, and that alphabetical classes like Fiction, Poetry and Essays should be boldly lettered with the first three letters of the author's surname, while *Individual* Biography only should be similarly marked with the surname letters of the subject of the biography, but not the author, save in the case of autobiographies, letters, etc. If it should be thought necessary to add the accession numbers, they

can be placed out of the way in the top half-panel, as shown in No. 7, while shelf colours for open access can be added at the points suggested in Section 321.

397. Specification.—A bookbinding specification should include every point which has any bearing on the cost, finish and workmanship of the books. As requirements differ in every library, it is impossible to attempt the drafting of a model specification which will meet every case, but the details set out in the following draft may prove useful and suggestive :—

DRAFT BOOKBINDING SPECIFICATION.

To the Public Libraries Committee

of.....

Date.....

Gentlemen,

..... undertake to bind books for the Public Libraries Committee in the manner specified below, at the prices stated in the annexed schedule, for one year from to

All books to be well beaten or rolled, and care taken to avoid set-off of ink in new books.

To be sewn one sheet on, on strong tapes; the first and last sheets to be enclosed at back in linen strips. All sections broken at the back to be enclosed in linen strips, and neatly overcast before being sewn to the tapes. Four tapes to be allowed for crown 8vos; other sizes in proportion. The tapes to be firmly secured between the back and front boards, which must be carefully split to receive them.

In leather-bound books, the backs to be made close and flexible, without bands, save in cases to be separately notified, but with blind fillets in imitation of bands. Leathers as specified in schedule, with smooth cloth sides to match colour of leathers.

In cloth- or pegamoid-bound books, the backs to be made open, with suitable linings. Edges to be very carefully cut, sprinkled and burnished, but only when the margins are not too small; otherwise to be left with proof and top edge only smoothed.

End-papers to be of stout, coloured, marbled or printed paper, with at least one white leaf before and after the printed matter. (Or as an alternative—the special library end-papers to be used in all books re-bound, etc.)

Linen or other strong cloth joints in all books.

Lettered in gold with author's name, title, class numbers, initials, etc., as per separate diagram showing arrangement of lettering for each class. The colours of leathers and cloths for each class to be as specified in the

Sec. 397] BOOKBINDING AND REPAIRING.

diagram. The order of lettering and colours to be maintained unless altered by the instructions, and class letters and numbers to be placed at a uniform height of two inches from the foot of each book, irrespective of size.

Include all wrappers and advertisement pages of certain magazines at the end of volumes, in their published order.

All materials used to be of the best quality, and the work done carefully and promptly. Deficiencies and irregularities in books, if any, to be reported to the librarian.

Each lot of binding to be finished and returned within weeks from the date of order.

Should there be any extras chargeable beyond those provided for in this specification, they must be reported to the librarian before the work is proceeded with.

Samples of the manner in which propose to bind books in accordance with this specification are sent herewith.

SCHEDULE OF PRICES.

| Sizes. | Half Levant Morocco. | Half Persian Morocco | Half Pigeon. | Half Roan. | No. 9 Peganoide Cloth. | Best Ordinary Cloth. |
|---|----------------------------|----------------------------|-----------------|---------------|------------------------------|----------------------------|
| Fcap. 8vo ($6\frac{1}{2}'' \times 4''$) . . . | | | | | | |
| Crown 8vo ($7'' \times 4\frac{1}{2}''$) . . . | | | | | | |
| Post 8vo ($8'' \times 5''$) . . . | | | | | | |
| Demy 8vo ($9'' \times 6''$) . . . | | | | | | |
| Medium 8vo ($9\frac{1}{2}'' \times 6''$) . . . | | | | | | |
| Royal 8vo ($10'' \times 6\frac{1}{2}''$) . . . | | | | | | |
| Imperial 8vo ($11'' \times 7\frac{1}{2}''$) . . . | | | | | | |
| Quarto ($11'' \times 8\frac{1}{2}''$) . . . | | | | | | |
| Folio ($13'' \times 8''$) . . . | | | | | | |

Prices of other sizes to be in proportion.

Extras:—

- Per inch for folios over thirteen inches.
- For lettering large initials in classes G, J, K and L per hundred.
- For mending torn or broken leaves.
- For guarding plates in linen, per dozen.
- For mounting and dissecting maps, etc., on fine linen, per square foot.

Signature of firm.

Some libraries use vellum instead of leather corners, while others have the corners of the leaves neatly rounded like a pack

of modern playing cards, and some have the boards rounded to correspond. It is a good plan to have the corners of the leaves slightly rounded, but there is no great benefit arising from any of the other items. Other points will doubtless crop up in the practice of every library, and these must be provided for as thought best. Metal corner-pieces let in between the split boards are not recommended.

398. Records and Checks.—When a lot of books for binding is sent out it must be accompanied by a set of instructions to the binder, and a copy of this must be retained at the library as a record and to check the books when returned. The most usual plan is to send out a binding sheet, ruled as follows,

| Date when sent. | Lettering. | Class and No. | Instruction. | Date Returned. |
|-----------------|------------|---------------|--------------|----------------|
| | | | | |

FIG. 137.—Binding Sheet (Section 398).

on which are entered the particulars of the books requiring binding. These particulars are also entered in a binding book, ruled exactly the same as the sheets, and in the last column of this the books are marked off as returned. It is usual to make the binder's messenger check over and sign for every lot of books at the end of the page. Another method, which possesses the advantage of enabling the binder to distribute the work in his workshop, and makes every book carry its own instruction, is

Sec. 398] BOOKBINDING AND REPAIRING.

as follows : Procure a large book of perforated slips, with a counterpart page, unperforated, behind every page of slips, in the style of a manifold order book. Have these pages ruled as below, and progressively numbered :—

| Progressive No. | Date of Despatch. | Lettering. | Class. | Material. | Date Returned. |
|-----------------|-------------------|------------|--------|-----------|----------------|
| 1 | | | | | |
| 2 | | | | | |
| 3 | | | | | |
| 4 | | | | | |

FIG. 138.—Binding Order Slip (Section 398).

When an order for binding is being made up each book is entered on a numbered slip, pencarbon or other copying paper being placed between the slips and the counterpart below. Dates can be stamped to save time. The slips are then detached and placed in the books to which they refer. An ordinary order form is then made out in some such terms as :—

Mr. will please bind as per contract and separate instructions the books sent herewith, comprising numbers to

The binder's messenger can sign the book on the last counterfoil, in a form like this :—

Received on from the Public Library
volumes for binding.

Or a rubber stamp with these words and blanks can be used. The object of the progressive number is to afford a ready means of identifying instructions and ascertaining in an easy manner the number of books bound in any one year. These numbers should also be written in ink at the end of the letterpress of each book, as a means of ascertaining how often any book has been re-bound. The price, if carried into the column reserved for the progressive number in the counterpart, will also be a useful record to keep. By simply referring to the progressive numbers it is possible to ascertain the price paid for successive re-bindings, and to keep a check on the whole of the work.

399. Repairs should not be entered in this book. It is better to use an ordinary order sheet and copy it in the press order book. It can be headed :—

Mr. will please re-case the following books :—

or

Mr. will please repair the following books, as per instructions added to each :—

For checking binders' charges the book scale printed on the "Library Remembrancer" (Section 86) will be found very useful. Sizes beyond this can be measured and checked by means of an ordinary foot-rule.

400. Miscellaneous.—Tape or ribbon BOOK-MARKS are sometimes placed in public library books, but a much more obvious and useful plan is to print a special book-mark with a folding-over tab, which can be placed in *all* books which are issued, and not confined simply to those which are re-bound. A good form of marker can have one or two pointed rules for the due care and preservation of books printed on it, as in the specimen opposite, based upon a suggestion which appeared in the *Library World* of 1900 :—

Sec. 401] BOOKBINDING AND REPAIRING.

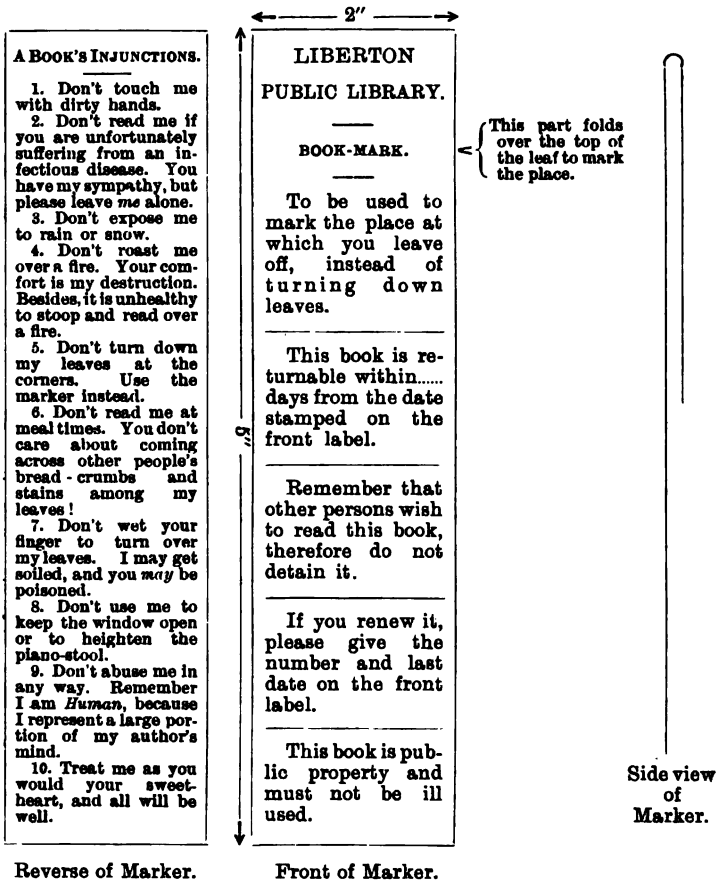

FIG. 139.—Book-mark (Section 400).

Some enterprising firms give away book-marks of various kinds, and many publishers insert advertising cards which serve as markers. But libraries cannot always afford to advertise sewing machines and insurance companies in this way, and a humorous marker such as we suggest is much more striking and likely to be obeyed, because official.

401. Special END-PAPERS have been introduced in a few

libraries to be placed in re-bound books. They serve the purpose of an ownership mark more effectually than a book-plate, but, of course, they can only be used in the books which happen to require re-binding. The Croydon end-paper is quite an elaborate design, resembling a wall-paper in appearance, and giving compartments showing the arms, monogram and a view of the town hall. End-papers of this kind are a luxury which few public libraries can afford.

402. An effective way of placing an indelible mark of ownership upon a public library book is to impress a blind stamp upon the outside front board. This can be done by means of a screw-press and a special die, and need not cost more than from £5 to £10. Any member of the staff can impress such a stamp, and it is better than confining this mark of ownership simply to books which have been re-bound. A circular stamp is best, as it will always appear straight.

403. The whole question of displaying PERIODICALS IN COVERS and without them is discussed in Chapter XXXII., Section 482. The ideal periodical cover has yet to be invented. Both as regards the means of fastening periodicals and securing durability of covers, all existing varieties could be greatly improved. So far as our experience goes we have met with nothing more satisfactory than half-pig-skin covers, made from good quality millboard. In the absence of a reliable mechanical fastening, leather thongs are about as effective as anything we have seen. The following suggestion, which appears sensible, was published in the *Library* in 1896 :—

404. "Periodical covers are a source of constant expense and worry, no matter what material they are made from they will get dirty, will wear out, and they are a nuisance to many readers because of their weight, etc. Take the average life of a cover for Cornhill as three years, and its cost at 2s. or 2s. 6d. It thus costs from 8d. to 1s. per annum to maintain, and will not be clean or nice after twelve months' use. Well, then, suppose a large number of libraries agree to give up cloth and leather covers in favour of another sort which can be easily and economically renewed, would a basis for co-operation not

be found wherein the elements of uniformity do exist? All have nearly the same magazines and periodicals, and all who use covers of the ordinary sort suffer from the same causes. If, therefore, it were possible to produce a characteristic and strong cover for each of the better-known periodicals made out of stout manilla paper or other substance, with the titles boldly printed wherever needful, would it be advantageous and economical for libraries to combine in order to get a constant supply of such covers? No doubt if a sufficient number of libraries undertook to use such covers they could be manufactured for next to nothing; and being so cheap, they could be frequently changed, and so enable a reading room to be kept always neat and tidy. The covers could be made in different colours for different classes of periodicals; they could be stout enough to protect the periodical in view of future binding, and cheap enough to admit of frequent change, if, in addition to a fairly large demand, the manufacturers were allowed to use the inner surfaces for advertisements. Librarians with opinions on the point might produce them for general consideration, and perhaps something substantial may result. There are practical points connected with the best material out of which to make such covers, and with such matters as fastenings, lettering, advertisements, and probable cost, which might be very fully elucidated."

405. REFERENCE LIST OF AUTHORITIES :—

- Bookbinding. Discussion. Lib. J., 1898, Conf. no., pp. 23, 82.
 Book-marks. P. L., 1901, p. 840.
 Book numbering and lettering, by S. L. L. W., v. 2, p. 190.
 Chivers, C. Practical bookbinding. L. A., 1901, p. 171.
 Davenport, C. Leather as used in bookbinding. L., v. 10, p. 15.
 Davenport, C. Notes on bookbinding. L., v. 5, p. 217.
 Fletcher, W. J. Durability of cloth bindings. Lib. J., 1898, p. 40. (Shows that American cloth-bound books went out on an average forty-three times, while English cloth books went out twenty-eight times, before re-binding.)
 Graesel, A. Library Binding. See his "Bibliothekslehre," 1902.
 Jast, L. S. Binders' Lettering. L. W., v. 3, p. 232.
 Johnston, D. V. R. Binding and binderies. Lib. J., 1891, Conf. no., p. 9.

- Johnston, D. V. R. Library binding. U. S. Educ. Rept., 1892-1893, v. 1, p. 907.
- Poole, R. B. Elements of good binding. Lib. J., 1892, Conf. no., p. 15.
- Stevenson, R. Binding of serials. L. W., v. 3, p. 266.
- Straight, M. W. Repairing of books. P. L., 1900, p. 88.
- Woodard, G. E. Notes on bookbinding. Lib. J., 1898, p. 231.
- See also Zahnsdorf's "Bookbinding" and various books on leather-work, arts and crafts, etc.*
- For list of abbreviations see Section 88.*

DIVISION IX.
PUBLIC SERVICE.
CHAPTER XXVII.

RULES AND REGULATIONS.

406. **General.**—Much of the success of a municipal library will depend on the rules and regulations adopted for its conduct and management. A considerable number of the rules which were drafted in the early days of the public library movement, while committees were still in ignorance of the demeanour of the rank and file of readers, require modification in these later days, when it has been definitely ascertained that nothing serious is to be apprehended from the conduct of 99 per cent. of the library frequenters. The original library committees regarded the general public through the spectacles of a police magistrate, and drew up their regulations on a quite unnecessary scale of severity. The whole tone of these codes was fraught with suspicion and distrust, and throughout their long course they were nothing but prohibitions against doing all sorts of things, from spitting on the floor to criticising the librarian.

407. The traditional respect for the good old times, which is at once the curse and the prime virtue of the British race, has led to the perpetuation of a considerable number of these severe rules; and in many libraries are still to be found ordinances which in no way reflect the modern library spirit, or indicate that the slightest attempt has been made to revise the regulations in consonance with the changed conditions of the present. Where such rules are still in force, it may be taken for granted that red tape, and not an intelligent effort to serve the public, is at the root of the matter. It is extraordinary to what an extent

certain library committees, especially those guided by timid or arrogant officers, will allow themselves to be blinded to the fact that a public municipal library is an institution based upon the broadest lines of mutual co-operation; in which every citizen has equal rights; and in which the rules should be drafted to protect the common proprietary rights, without penalising any section of the community. To judge by some of the rules which have been published one would imagine that a public library was a kind of private trust or benefaction to which the citizens had the privilege of entry, subject to the caprice or good nature of a committee of owners, who had drawn up certain drastic rules to protect their personal property from the onslaughts and unwelcome attentions of a horde of goths and vandals. Fortunately this narrow, grudging spirit is rapidly dying out, and signs are not lacking of a general change in the direction of sweeping away useless and irksome restrictions upon public rights and liberties. We must not be construed as condemning library committees entirely as the leaders or even encouragers of these attempts to repress the shareholders in municipal libraries. A large proportion of this tendency is traceable to the influence of librarians trained in old-fashioned methods, or those who are not sufficiently in sympathy with public requirements to exercise a wise discretion in the application of the regulations which they are appointed to enforce. There are, we are sorry to confess, librarians whose only idea of their duty to the public consists of a rigorous and indiscriminate execution of the rules and regulations. Such devotion is commendable in many ways, no doubt, but it is more what would be looked for in a warder or door-keeper than in an educated officer appointed to assist and guide the public, and to forward, not obstruct, the people's aspirations in educational directions.

408. Hours.—The number of hours during which municipal libraries should remain open to the public will vary according to the local conditions, staff and funds of every town or district. In small places, with scanty populations and very little libraries with but one attendant, a few hours open at night on several days in the week, according to requirements, will serve every

practical purpose. In towns of a fair size, say from 10,000 to 30,000 of a population, the reading rooms should be open all day, uninterruptedly from 10 to 10, but the lending library need only be kept open from 10 to 2 and from 5 to 9. In large towns of over 40,000 inhabitants, the libraries should remain open all day from early morning till late at night—say from 8 A.M. till 10 P.M. for newsrooms; 9 A.M. till 10 P.M. for reference libraries; 10 A.M. till 9 P.M. for lending libraries; and 5 till 9 P.M. for juvenile departments, if any. There should be no interruptions to these services, either in the way of half- or whole-day closing to suit the staff, or any irregularity in hours on any plea whatsoever. The public library is a bureau for the supply of information, and should be found open at any time in a working-day, during which people are likely to use its resources. We have already argued (Section 97) that in large towns there is no necessary connection between the public hours and the staff, and we again urge that in an important matter of this kind, which affects the convenience of hundreds of people, the question of employing extra assistance, in order to keep the library open all day and every day without overworking the staff, should never be hesitated over. A public library which is not available at all reasonable times is not performing its work so effectually as it otherwise might, were full consideration given to public requirements. It may be argued that if one town of a certain size can keep its public libraries open all day and every day (save Sundays and holidays, of course), every similar town and all larger ones can easily do likewise. But, as may be seen by reference to Greenwood's *British Library Year Book*, 1900-1901, this is not invariably the case. For some unaccountable reason several of the library areas in the great metropolitan centre of London close, in whole or in part, one or more of their departments at least once a week. This contrasts most unfavourably with the enterprise shown by many small provincial towns, with half the means and less need to keep open, which, without overworking the staff, remain open all day to meet the requirements of all classes. A careful and well-constructed time-sheet will often get over difficulties which may seem to arise from

under-staffing or other conditions. We know of libraries in which, largely because of a badly constructed time-sheet, the assistants are given but one evening off weekly, and work from eight to nine hours daily, although the library is closed for a half-day every week, and thus both assistants and public are incommoded.

409. Age Limits.—There are wide differences in the practice as regards the limit of age under which persons are allowed to use the libraries, but within recent years the opinion on this point has undergone a very considerable change. Formerly persons under eighteen and sixteen were forbidden the use of public libraries; now such high limits are very uncommon, though fourteen is still too frequently seen in the rules of otherwise progressive libraries. Of course, local conditions must receive due consideration in this matter, though we cannot think of any circumstance which calls for any distinction being made between children of twelve and those of fourteen years of age. There are hundreds of bright intelligent lads and girls of twelve who are the equals in knowledge and ability of their fellows of thirteen and fourteen years of age, and it seems wrong to fix any arbitrary age limit like thirteen, fourteen, fifteen and sixteen, when at twelve many children are discharged from the board schools. What we should like to see would be the entire abolition of age limits in lending libraries, subject to the reservation that the librarian and his or her staff should have full discretionary power to refuse to issue books to any child unable to read and write. Failing this, the limit might be fixed at twelve where there are no separate juvenile libraries, but reduced to eight where such departments exist. We recognise a certain amount of trouble and inconvenience to adults which would result from admitting very young children, especially in open-access and other libraries without separate juvenile accommodation, and this would be partly met by the compromise proposed. Separate juvenile departments are the solution of the difficulty, and, when these can be provided all round, the age limit downwards can be abolished so far as they are concerned, while the limit for the adult library can be raised

to twelve. But adequate provision should be made for interchanging, and all necessary facilities provided for enabling intelligent young people under twelve to procure more advanced books if desired, and also for allowing old men of seventy and eighty to procure the works of Ballantyne, Henty and other authors whom people in their second childhood appreciate and admire!

410. As regards age limits in reference libraries and reading rooms, there is more to be said for keeping them high than in the case of lending libraries, especially when there are separate juvenile reading rooms. But, generally speaking, we can see no strong reason for excluding well-conducted boys or girls from a popular reading room, whatever their ages may be, provided they do not come during school hours, or do not otherwise make the library a place in which to hide from some duty. In some libraries, with age limits of twelve, fourteen or over, we believe it is the practice to turn away younger children from news and reading rooms in cases where they are accompanied by their parents or elders. This is a monstrous misconstruction of a rule which was only intended to protect readers from the noisy incursions of irresponsible juveniles, who are wont to stray into public places out of sheer devilment, or accident, or excess of curiosity. To apply this rule to children in arms, or youngsters accompanied by and in charge of their elders, is simply a wanton and mischievous abuse of officialdom, which is calculated to greatly injure the popularity and prestige of municipal libraries in the eyes of all self-respecting citizens. The age limit for a reference library designed for students, with open access to the shelves, should be fixed at twelve, with discretionary power to the librarian to grant permits to any studious youngster under that age. Where access to public reading rooms and juvenile departments is easy, there seems no good reason for throwing open the reference library to all and sundry, unless under the safeguards suggested.

411. **The Borrowing Right.**—There are several points in connection with the borrowing rights of various classes of citizens which we desire to notice, especially as they have much bearing on the question of a library's popularity and

good management. In some towns the borrowing right is strictly confined to ratepayers or residents in the library district. Employees who live outside the district are excluded, but for what particular reason it is difficult to understand. An employee contributes directly to the material well-being of the district in which his work lies; he contributes indirectly but very substantially towards the payment of the rates; he spends most of his waking and all his work hours in the district; and in other ways he is as much a citizen as the resident who works outside the district and only sleeps in it at night. We have been unable to trace any reason for the distinction made between employee and resident in some places, and would point out that plenty of large towns grant the borrowing right to employees without the slightest inconvenience, difficulty or injustice to any one. We hope the places which still adhere to this antiquated rule will soon fall into line with more advanced and liberal districts.

412. Another regulation which tells against the interests of municipal libraries is that in which every intending borrower, ratepayer or otherwise, is required to obtain the signatures of one or two registered ratepayers as guarantors before a ticket will be issued. It is not necessary to imagine reasons for this very serious obstacle to intending borrowers. Since many large and small towns dispense with this needless precaution in the case of ratepayers, and allow non-ratepayers and compounding householders to have tickets on the guarantee of *one* ratepayer or on leaving a small deposit, there is no reason at all why this elaborate double guarantee should not be abolished all round. The time will doubtless come when guarantees of all kinds will be abolished.

413. There are other antiquated and needless restrictions in connection with the borrowing right which we shall not specify at length, but group together here as examples of thoroughly bad rules for which there is very little justification.

1. The illegal charge of 1d. or 2d. for tickets or voucher forms, still levied in some places in defiance of the Public Libraries Act, 1892, Section 11, Sub-section (3); and various judicial decisions.

2. Requiring more than three days' notice before issuing a borrower's ticket. (In some places borrowers are required to wait for a week or fourteen days from the date of lodging their applications for tickets.)
3. Limiting the time for reading books to less than fourteen days.
4. Refusing to renew books by post-card or letter, and requiring that the actual books shall be brought back to be re-dated.
5. The imposition of fines amounting to more than 1d. per week or part of a week for overdue books. (In certain libraries, some of which are not pressed for funds, the exorbitant fine of 1d. per day is imposed for overdue books, with a time limit of seven, ten and fourteen days. This question is further considered in Section 414.)
6. Refusing to exchange books on the same day as that on which they are issued. (As the books which are brought back for exchange are usually those which the borrowers have read previously, there seems little need for such a disobliging and Jack-in-office rule.)
7. Refusing to issue books on the same day as that on which they are returned to the library. (A common practice in the old-fashioned libraries, worked by means of charging ledgers, but still found in several much more up-to-date libraries worked by means of indicators. The same craze for tantalising the public has in a minor degree infected some open-access lending libraries which will not reissue returned books until they have been replaced on their shelves by the assistants.)
8. Charging borrowers 1d. or 2d. as a penalty for losing their tickets and requiring them to be reissued. (Query, a contravention of the Act.)
9. Disallowing the use of ink for copying purposes under all circumstances.
10. Allowing only one volume at a time to borrowers.
11. Restricting the number of books which a reference reader may have at one time.

414. Fines and Penalties.—So long as the present rate limitation remains as fixed by successive Acts of Parliament, fines will continue to be levied in British municipal libraries. There is no doubt that the small incomes realised in most public libraries from the niggardly provision made by Parliament is one cause of the efforts made in many cases to increase funds, by imposing fines of varying degrees of severity upon the borrowers from lending libraries. This is, indeed, the principal reason, though we are told that, but for penalties of some sort, books would never be returned at all. There may be some truth in this, as regards a small proportion of borrowers, but the experi-

ence of Manchester and some American towns where no fines are imposed at all rather modifies the statement as to the supposed disastrous effects of non-fining. This, like many another question, is one on which the inexperienced theoretical objector can come out strong, by appealing to his imagination for details of all sorts of hardships, inconveniences and dangers arising as the result of abolishing fines. We have never heard a single discussion in which the slightest consideration was given to the case of the reader who has to pay these library fines. Every argument is directed towards showing how the library would suffer, and incidentally it has been mentioned that, perhaps, the undue retention of a popular book would prove very highly inconvenient to other readers who wanted it. These matters we need not discuss, since it must be obvious that popular books can always be duplicated to a certain extent; that more diligence can be exercised in the tracing, pursuit and ingathering of overdue popular books; and that there are methods of punishing hardened delinquent borrowers of this kind, by suspending their tickets, as is done at Manchester without serious results. But it is quite evident that in Britain fining for overdue books must be maintained until it is declared illegal—and no doubt, with bye-laws not legally confirmed, it is a doubtful practice, in England at all events—or Parliament has removed the rate limitation or provided other means of financial assistance, without all this scraping, pinching and doubtful means of increasing funds. What we would plead for is more latitude in the imposition of fines, and a less eager desire to make money over the business than is implied in such fines as 1d. a day, and the monstrous fines of two, three, four and five cents, as charged in some American libraries. No library has a right or any need to make a profit out of such a transaction as fining overdue books, and we should like to see a uniform charge made of 1d. per week, or portion of a week, for books retained over a fortnight, when not renewed by postcard or otherwise.

415. **Holiday- and Sunday-Opening.**—Whether libraries are to be opened or not on public holidays and Sundays is largely

a matter for local option. In some places libraries have been experimentally opened on PUBLIC HOLIDAYS on the sentimental plea that many persons are unable to use them at any other time, and the result has been anything but encouraging. In other places, like sea-side and holiday resorts, they have been opened on such holidays, with decided advantage to trippers seeking shelter from inclement weather. Generally speaking, we think libraries should all be *closed* on public holidays, on the grounds that a general holiday should be generally observed as such, and that people are much better in the fresh air than sitting indoors in libraries or anywhere else on such occasions. If any exception to this opinion were made at all, we should say open only on wet and stormy public holidays, but always except Christmas, and, in the case of Scotland, New Year's Day. The public holidays in Britain are too few and far between to effect any radical influence upon libraries or readers.

416. As regards SUNDAYS, conditions are rather different. To begin with there are more of them, and they come at regular intervals. But unless the need for Sunday-opening can be demonstrated by a satisfactory result derived from a series of trial openings, we should advise the libraries not to be opened as a mere concession to the views of certain societies, or the supposed utility of the movement to people who cannot come on week-days. If experiment proves that Sunday-opening is meeting a crying need, open the libraries by all means, but not otherwise. As a compromise we suggest that if Sunday-opening is decided upon, the reading rooms only should be open between the hours of 3 and 9 P.M. on every Sunday between October and May inclusive. There is little need for Sunday-opening in warm weather—people are much better out-of-doors—especially if, as is usually the case, attendances fall off greatly.

Should the Sunday-opening question become a burning one in any town, arrangements might be made to open the reading room and reference library, provided at least 500 citizens take out tickets as an earnest of their intention to use the library. We are not aware if in any town Sunday-opening has been

limited to students and other inquirers, but it would form a reasonable manner of settling a difficult question should opinion be sharply divided in any town.

As regards ways and means of carrying on the business of a public library on holidays and Sundays, special arrangements must be made, both as regards the necessary attendants, heating, lighting and cleaning.

417. **Enforcement of Rules.**—There is nothing in the original English or Irish Acts which gives power to enforce rules and bye-laws, but in the Act of 1901 such may be obtained provided the rules are approved by a magistrate or justice of the peace. In the Scotch Act very full provisions are made for the confirmation and enforcement of bye-laws. Clause 22 of the Act of 1887 reads: "It shall be lawful for the committee to make bye-laws for regulating all or any matters and things whatsoever connected with the control, management, protection and use of any property, articles or things under their control for the purposes of this Act, and to impose such penalties for breaches of such bye-laws not exceeding £5 for each offence, as may be considered expedient; and from time to time, as they shall think fit, to repeal, alter, vary or re-enact any such bye-laws, provided always that such bye-laws and alterations thereof shall not be repugnant to the law of Scotland, and before being acted on shall be signed by a quorum of the committee, and, except in so far as they relate solely to the officers or servants of the committee, such bye-laws shall be approved of by the magistrates and council, or the board, as the case may be, and shall be approved of and confirmed by the sheriff of the county in which the burgh or parish, or the greater part of the area thereof, is situated." Provision is also made for advertising and giving due notice of intention to adopt the bye-laws.

418. It should be stated, however, that there are quite a number of cases in which magistrates' decisions in England have upheld the rules of Public Library Committees with regard to recovery of fines for overdue books, the value of books lost and guaranteed, and on other points. In some of these cases it has not been held or suggested that guarantee or voucher forms

should be stamped as agreements, or that any limit under £5 should be placed on the amount of the guarantor's liability. Nevertheless, we think a value limit of £1 or £2 should be placed upon a guarantor's liability, and that will dispose of the awkward point as to the agreement being stamped.

419. **Draft Rules and Regulations.**—These draft rules are based upon a careful examination of the principal bye-laws adopted by many of the principal libraries in Britain and the United States, with certain modifications to harmonise them with certain leading principles advocated throughout this book. No two places are exactly alike in all their circumstances and local conditions, so that no library is likely to adopt these rules exactly as they stand. But they contain suggestions which may be found useful in drawing up and adopting a series of suitable rules, and enabling most vital points to be met. Some libraries have an enormous number of rules, amounting in some cases to fifty or sixty items, but many of these are quite unnecessary and need not be considered. The draft rules drawn up by the Local Government Board may be obtained if thought needful; but they are printed separately in the *Library Association Record*, 1903, p. 28. The fewer and simpler the rules the more likely are the people to read and observe them.

LIBERTON PUBLIC LIBRARY.

RULES AND REGULATIONS.

GENERAL.

1. The Liberton Public Library is a society established for purposes of literature and science exclusively. The librarian shall have the general charge of the library, and shall be responsible for the safe-keeping of the books and for all the property belonging thereto.
2. The library is supported in part by a rate levied in accordance with the Public Libraries Acts and in part by annual voluntary contributions of money and gifts of books and periodicals. The library committee shall not make any dividend, gift, division, or bonus in money unto or between any of the members.
3. Admission is free to all parts of the library during the hours of opening, but no person shall be admitted who is disorderly, uncleanly or in a state of intoxication. Smoking, betting and loud conversation

- or other objectionable practices are also forbidden in the rooms or passages of the library.
4. The librarian shall have power to suspend the use of the ticket of any borrower, and refuse books or deny the use of the reading rooms to any reader who shall neglect to comply with any of these rules and regulations, such reader having the right of appeal to the library committee, who shall also decide all other disputes between readers and the library officials.
 5. Readers desirous of proposing books for addition to the library may do so by entering, on slips (or in a book) kept for the purpose, the titles and particulars of publication of such books, which will then be submitted to the committee at their first meeting thereafter. All suggestions on management to be written on slips or sent by letter to the committee.
 6. Any person who unlawfully or maliciously destroys or damages any book, map, print, manuscript or other article belonging to the libraries shall be liable to prosecution for misdemeanour under the provisions of 24 & 25 Vict., c. 97, *An Act to consolidate and amend the Statute Law of England and Ireland relating to malicious injuries to property*, 1861. The provisions of the statute entitled 61 & 62 Vict., c. 53, *An Act to provide for the punishment of Offences in Libraries*, 1896, shall also apply.

REFERENCE DEPARTMENT.

7. The library and reading room shall remain open on week-days from 9 A.M. till 10 P.M. (and on Sundays, from October to May inclusive, from 8 to 9 P.M.), but shall be closed on Christmas Day (New Year's Day), all public holidays and such other days as the committee may from time to time appoint.
8. Every person on entering the reference library shall sign his or her name, with the correct address, in a book kept for the purpose. Any one giving a false name or address shall be liable to prosecution, and shall not afterwards be allowed to use the library.
9. Every person before leaving the room shall return the book or books consulted into the hands of the librarian or his assistants, and must not replace books taken from the open shelves, but leave them with the assistant at the exit.
10. Any work in the lending department, if not in use, excepting those in Class K, Fiction, may be had on application at the reference library counter for perusal in the reading room, but on no account must such books be taken from the room.
11. Illustrations of all kinds may be copied, but not traced, save by permission of the librarian. Extracts from books may be copied in pencil. The use of ink is only permitted at certain tables which are

reserved for the purpose. Certain works are only issued after a written application to the library committee.

LENDING DEPARTMENT.

12. The lending library is open daily for the issue and receipt of books every week-day from 10 A.M. till 9 P.M., but shall be closed on Sundays, Christmas Day (New Year's Day), all public holidays and such other days as the committee may from time to time appoint.
13. Books shall be borrowed for home reading only by persons rated, resident or employed in the Borough of, or qualified by Rule 18.
14. All persons whose names appear on the current Roll of Electors of the Borough may borrow books on their own responsibility, after filling up an application for a borrower's ticket on a form provided for the purpose.
15. Other residents, and non-resident employees in the borough, may borrow books, but must first obtain a guarantee from a duly qualified person, as defined in Rule 14, and must sign an application for a borrower's ticket, on forms to be provided by the librarian. But no such guarantor shall be allowed to assume responsibility for more than three other persons, unless by special arrangement with the committee, and in no single case shall his or her liability exceed £2 per person guaranteed.
16. Any person resident or employed in the borough, unable to obtain the signature of a qualified resident as a guarantee, may borrow books on leaving a deposit of 10s. with the librarian. The guarantee of the recognised head officials of Government departments, Friendly Societies and similar organisations may be accepted at the discretion of the Committee in lieu of an ordinary guarantee, for persons who are employed in the district.
17. The Application and Guarantee Form, duly signed, must be delivered to the librarian, and if, on examination, it is found correct, the borrower's ticket will be issued three days after (excluding Sundays), but will only be delivered to the borrower in person. This ticket will be available at the central library or any branch or branches.
18. In accordance with Section 11 of the Public Libraries Act, 1892, the committee will lend books to persons, other than those duly qualified under Rules 13-16, who pay an annual subscription of 7s. 6d.; but such borrowers must conform, in every respect, to all the rules of the library, and shall have no privileges other than those possessed by the other borrowers.
19. The committee shall issue additional tickets to readers, available for all classes of literature save Fiction. Any duly enrolled borrower may have one of these extra tickets on filling up an application form as

- for an ordinary ticket. School teachers may have more than one ticket of this class on application to the librarian.
20. All tickets and vouchers must be renewed annually; each ticket and voucher being reckoned available for one year from date of issue.
 21. The borrower must return each volume lent within fifteen days, including days of issue and return, and shall be liable to a fine of 1d. per week or portion of a week for each volume lent, if not returned within that period, but the issue of a book may be renewed for a further period of fifteen days, dating from the day of intimation, on notice being given to the librarian either personally or in writing, and no further renewal will be allowed if the book is required by another reader. Books which are much in demand may, however, be refused such renewal at the discretion of the librarian.
 22. Each volume on return shall be delivered to the librarian or his assistant, and if on examination it be found to have sustained any damage or injury, the person to whom it was lent, or his or her guarantor, shall be required to pay the amount of damage done or to procure a new copy or series of equal value, and, in the latter case, the person supplying the new copy shall be entitled to the damaged copy or series on depositing the new one.
 23. Borrowers who are unable to obtain a particular non-fictional book, and desire that it shall be retained for them on its return, must give its title, number, etc., to the assistant, and pay 1d. to cover cost of posting an intimation that it is available for issue; but no book will be kept longer than the time mentioned in the notice sent. Novels cannot be reserved under this rule.
 24. Borrowers are required to keep the books clean. They are not to turn down or stain the leaves, nor to make pencil or other marks upon them. They must take the earliest opportunity of reporting any damage or injury done to the books they receive, otherwise they will be held responsible for the value of the same.
 25. If an infectious disease breaks out in any house containing books belonging to the library, such books are not to be returned to the library, but must be handed over to the Medical Officer of Health or any sanitary officer acting on his behalf. Until such infected house is declared free of disease by the Medical Officer of Health, no books will be issued from the libraries to any person or persons residing therein. In similar circumstances non-resident ratepayers or employees must return their books to the Borough Medical Officer, and cease to use the libraries till their residences are certified free from infection.
 26. Only actual borrowers who are enrolled on the register of the library shall have the right of direct access to the book-shelves, but their representatives may be admitted at the discretion of the librarian or his

- assistants. To prevent disappointment, these representatives should come provided with a list of several book-titles and numbers.
27. Any change in the residence of borrowers or their guarantors, or notice of withdrawal of guarantee, must be intimated to the librarian within one week.
 28. Borrowers leaving the district or ceasing to use the library are required to return their tickets to the librarian in order to have them cancelled; otherwise they and their guarantors will be held responsible for any books taken out in their names.
 29. No person under twelve years of age shall be eligible to borrow books or make use of the adult library, except by the librarian's permission.

GENERAL READING AND MAGAZINE ROOMS.

30. The general reading room shall remain open on week-days from 8 A.M. till 10 P.M., and the magazine room from 9 A.M. till 10 P.M. (and on Sundays, from October to May inclusive, from 8 to 9 P.M.). Both rooms shall be closed on Christmas Day (New Year's Day), all public holidays, and such other days as the committee may from time to time appoint.
31. No persons under twelve years of age, unless accompanied by their parents or elders capable of controlling them, shall be allowed to use these rooms, except by permission of the librarian or his assistants.
32. Any persons who use these rooms for purposes of betting, or who in any way cause obstruction or disorder in these or any other rooms or passages of the libraries, are liable to be proceeded against under the provisions of 61 & 62 Vict., c. 53, *An Act to Provide for the Punishment of Offences in Libraries*, 1898.
33. Readers in possession of newspapers or other periodicals must be prepared to resign them to any other reader who may ask to peruse them, ten minutes after the request has been made through one of the library staff.

JUVENILE ROOM.

34. The juvenile reading room and library shall remain open from 5 till 9 P.M. daily on Monday to Friday inclusive, and from 10 A.M. till 9 P.M. on Saturdays.
35. The admission is free to every boy or girl residing in the Borough ofwho is able to write and read; but they must obtain a guarantee from their parents or school teacher as to good behaviour and safe return of all books.
36. Application for tickets admitting to the room must be made at the library.
37. There are certain admonitory rules which are best displayed in frames in placard form, such as

SILENCE
IS REQUESTED.

NO CONVERSATION ALLOWED.

NO DOGS ADMITTED.

CYCLISTS ARE REQUESTED TO KEEP THEIR
MACHINES OUTSIDE THE BUILDING.

PLEASE WIPE YOUR BOOTS.

NO ADMISSION THIS WAY.

NO SMOKING ALLOWED.

and so on. Some of the general rules would be much more effective if displayed in this form.

420. Notes on Rules.—1 and 2. These rules are included for the purpose of qualifying for the certificate of exemption from local rates, as described in Sections 60-63.

15. In some libraries the guarantee of responsible heads of large government and other departments is accepted for all the employees, and secretaries of associations and school teachers have also been accepted. In the first case the association has become responsible for all its eligible members, and signs through its secretary. In the second case the teacher assumes responsibility for all his eligible pupils. Some libraries have abolished the guarantee for non-ratepayers.

16. DEPOSITORS should be treated exactly the same as ordinary borrowers, and their tickets and numbering should go

through the same routine. The money received from deposits may either be paid into the bank and repaid as wanted by depositors from petty cash, or held by the librarian and repaid when called up. Deposit money of this kind when paid into the bank tends somewhat to complicate and falsify the accounts by recording receipts which do not belong to the library, and inflating the petty cash expenditures. The practice differs in all places as regards this point, and we recommend librarians to keep a separate account of these moneys, whether paid into the bank or not.

18. Under the powers conferred by the 1892 Act, many public libraries now permit persons residing outside the district who are not otherwise qualified to become borrowers on payment of an annual SUBSCRIPTION, ranging from 5s. to 10s. The money received from this source should be paid into the subscription's account at the bank, and a proper receipt given to the subscriber, showing how long the subscription is current.

21. The RENEWAL OF BOOKS is generally allowed without question, if no inquiries for them in the interval have been recorded. In other cases, such renewals must, of course, be refused, unless the books are not returned, in which case nothing can be done. Here again the eternal fiction question crops up, and there are reasonable doubts if the right of renewal should be allowed in the case of novels. With heavier books it is quite another matter, and students should certainly be allowed to renew within all reasonable limits. A form of renewal slip is used at some libraries which may be useful. Copies are taken away by any borrower who thinks he may require them, and if he desires to renew a book, he simply fills up a slip and sends it by hand or post to the library. The assistant then picks out the card from the charging system and redates the book-card, leaving the renewal slip in the pocket. The renewals are all picked out and sorted in one sequence behind a special guide, so that when a book is returned which has not been redated, it is easy to find it. Renewals should count as reissues, and a record should be made of the issue of all books which are thus renewed.

| |
|---|
| <i>Book No.</i> |
| <i>Issued</i> |
| <i>Renewed</i> |
| <i>Fine</i> |
| This Ticket should be returned when renewing the Book. |
| LIBERTON PUBLIC LIBRARY. |

FIG. 140.—Renewal Slip (Section 420 (21)).

23. The practice of RESERVING BOOKS has been adopted in many libraries, and within certain limits it is useful. The chief points connected with the matter are whether all books should be reserved, and how many orders for the same popular book should be booked at once. As regards the first point, we are inclined to exclude Fiction from the operation of the rule, partly for the reason that in this class duplicates of popular novels are generally stocked, and also because it is necessary in a democratic institution like a public library to restrict as much as possible any privilege which may seem to favour one class to the exclusion of another. There is no doubt that the charge of 1d. will practically exclude many poor people from participating

in this method of book-reservation, and we therefore advise the limitation of the practice to non-fictional works only. As regards the second point, librarians will have to exercise a nice discretion as to how many readers they will place on the rota at one time, as it is quite conceivable that to book any popular work twenty or thirty times ahead is simply to cut it off from general circulation for an indefinite period. In the case of very popular books, the possibility of buying a special copy for reservation should be contemplated. As regards the method of working the system of reserving books, the usual plan is to sell a 1d. post-card to the borrower, who addresses it to himself and enters the name of the book wanted. These post-cards are then returned to the librarian, who arranges them in order, and, as the books are stopped on return, sends out the post-card next in order. A usual form for the post-card is as follows: "Please note that the book reserved by you, has now been returned, and will be kept for you till the evening of". The assistant fills in the date when the book should be claimed. Of course, borrowers who fail to claim miss their turn. A separate register of these reserved books can be kept in addition to the cards, if thought advisable. A receipt should, of course, be given for each 1d. received, and in some libraries the numbers of the books reserved are written on the counterfoils.

25. INFECTIOUS DISEASES NOTIFICATION.—Authorities differ greatly on the point as to the power of books to carry and disseminate disease. American and English bacteriologists, after exhaustive searches and tests, say that dirty books cannot convey infection, whilst German and French scientists declare that they can. As library assistants are continually turning over, handling and inhaling the dust, etc., from lending library books without bad results, we may infer that the danger of infection, if it exists at all, is greatly exaggerated. But as the public mind is somewhat excited over this question, it is necessary for public library authorities to take steps to reassure the people that everything is done to prevent disease being communicated through the medium of library books. The Public Health Acts are quite

clear on the point that persons suffering from infectious diseases, or in charge of other persons so suffering, are liable to penalties for lending any article; and this, we assume, would cover the case of a library which reissued a book which came from an infected house. The practice should therefore be for the local sanitary authority to seize all library books found on disease-infected premises, and simply destroy them after due notification to the library authority. A further notification should be sent to the library when the house has been disinfected and declared free from disease, as in the meantime the librarian has stopped the issue of books to persons in the disease-stricken house from the date of the first intimation. There are various forms of notice used for notifying when and where disease breaks out, and what books are destroyed, and also for declaring the infected house free from disease. As regards the disinfection of books, we believe it cannot be properly done without destroying the bindings, and it is best to take the extreme course in view of the public fears. As regards the cost of replacing such destroyed books, the local sanitary authority can be called upon to do this under the provisions of the Public Health Acts, but unless the annual loss is very great, it seems hardly advisable to raise the point. In small places or towns with very limited book funds, the sanitary authority should certainly be asked to replace all books which are destroyed. It is a wise plan to keep a separate record of books which are destroyed in the interest of the public health. This need not note any further particulars than the dates, titles and numbers of books, and cost. A column can be reserved for remarks.

421. REFERENCE LIST OF AUTHORITIES :—

RULES.

- Brett, W. H. Regulations for readers. U. S. Educ. Rept., 1892-1893, v. 1, p. 989.
- Dana, J. C. Public service. *See his Library Primer*, pp. 122-139.
- Duval, L. M. Library hours (opening and closing hours). P. L., 1900, p. 379.

FINES.

- Browne, N. E. Library fines. Lib. J., 1898, p. 185.
Collection and registration of Fines. Symposium of American librarians.
Lib. J., 1891, pp. 103, 137, 170, 207.
Hartley, M. E. Time-limit in the loan of books. L. W., v. 3, p. 206.
Another view, p. 322.

SUNDAY-OPENING.

- Barnett, Canon. Sunday labour in public libraries, etc. Greenwood's
Year Book, 1897, p. 102.
Cutler, M. S. Sunday-opening of libraries. U. S. Educ. Rept., 1892-1893,
v. 1, p. 771.
Greenwood, T. Sunday-opening of public libraries. See his "Public
Libraries," 1894, p. 458; and the tables in the "British Library Year
Book," 1900, pp. 236-253.

INFECTIOUS DISEASES.

- Books as carriers of disease. Lib. J., 1896, p. 150.
Johnston, T. The Replacement of "Infected" books. L. W., 1901, v. 4,
p. 6.
Willocock, W. J. Notification of infectious disease and the public library.
L. W., 1899, p. 89.

For list of abbreviations see Section 88.

CHAPTER XXVIII.

REGISTRATION OF BORROWERS.

422. **Voucher Forms.**—There are all kinds of voucher forms in use in the municipal libraries of the United Kingdom, ranging in size from foolscap folio to that of a post-card. These vouchers are the application forms on which borrowers apply for tickets entitling them to use the library, and they form the basis of the necessary registration of borrowers which all libraries must perform. It is not needful to describe more than one form, because it is gradually being adopted, with variations to suit different localities, as the standard system of the country. The legal questions connected with the validity of certain forms of guarantee are also beyond the scope of this article, because judicial rulings have been obtained on all kinds of forms, and the only point requiring consideration, that of the amount of a guarantor's liability, has already been discussed in Section 417.

A form of voucher which can be used as a movable card is preferable to a large slip, which requires binding in volumes, or other special means of preservation; and the size and style of card given opposite will be found satisfactory.

These voucher cards should be printed on a stout, tinted material, say, green or pink in colour, and handed free to any ratepayer or resident entitled to borrow books on his or her own guarantee. When returned filled up, they are duly examined to ascertain if the applicant is a duly qualified person, and when this is done the card is filed, after it has been numbered from

Sec. 423] **REGISTRATION OF BORROWERS.**

the number book, and the borrower's card made out. The space in the top left-hand corner is to hold the borrower's name, boldly written in as a catch-word for alphabetical arrangement. The No..... space at the top right-hand corner is for the borrower's progressive number. The Date..... space at the bottom left-hand corner is the date of application, which also becomes the date of expiry one year later. The Register No..... space at the bottom right-hand corner is for the applicant's number on

No.....

PUBLIC LIBRARY, LIBERTON.

I,..... of.....

being a Resident in the Borough of Liberton, in terms of Rule No. 14, hereby make application to the Public Library Committee for a Borrower's Ticket, entitling me to borrow Books from the Lending Library; and I hereby undertake to replace or pay the value of any Book belonging to the Committee which shall be lost or in any way injured by me. I also further undertake to pay the fines and all expenses incurred in recovering the same, in accordance with the Rules and Regulations, to which in all respects I hereby bind myself.

Date.....

No. on Register.....

FIG. 141.—Voucher for a Ratepayer Applicant (Section 422).

the current electors' roll. It is a useful thing to mark this roll with the numbers of the cards of any borrowers for whom a ratepayer may be guarantor, in all cases where a limit is put to the number whom one person may guarantee. There is generally plenty of marginal space for this purpose.

423. Passing now to the voucher forms for non-ratepayer applicants, the following are examples of a good style of card, showing the information and guarantee form occupying both sides:—

←————— 5" —————→

No.....

PUBLIC LIBRARY, LIBERTON.

I,..... of

..... employed at

..... being over..... years of age,

hereby make application to the Liberton Public Library Committee for a Borrower's Ticket, entitling me to borrow Books from the Lending Library, in accordance with the Rules and Regulations thereof, with which I hereby undertake to comply, and I submit on the other side the guarantee which I have obtained.

Date.....

[OVER

FIG. 142.—Front of Voucher for Non-Ratepayer Applicant (Section 423).

GUARANTOR'S VOUCHER.

The Applicant must obtain the following Voucher signed by a Resident as a Guarantee:—

“I, the undersigned, being a Resident in the Borough of Liberton, in terms of Rule No. 15, declare that I believe this applicant to be a person to whom Books may be safely entrusted for perusal; and I hereby undertake to replace or pay the value of any Book belonging to the Liberton Public Library Committee, to the amount of £2, which shall be lost or in any way injured by the said borrower; I also undertake to pay the fines and expenses incurred in recovering the same.”

Name.....

Address in Liberton.....

.....

Date..... Ward.....

No.....

[SEE OVER

FIG. 143.—Back of Voucher for Non-Ratepayer Applicant (Section 423).

Sec. 425] REGISTRATION OF BORROWERS.

The vouchers for non-ratepayer applicants should be dealt with the same as those for ratepayers, *viz.*, checked with registers and filed in the alphabetical order of surnames, after tickets have been made out and an entry made in the number book.

Vouchers for juvenile applicants can be made out in a somewhat similar form, with such necessary alterations as may be required to suit local conditions.

424. Vouchers for students or duplicate cards require no separate wording. The word **DUPLICATE** stamped boldly across one corner will be sufficient to denote the difference. The same holds good with regard to vouchers for those who make a deposit in lieu of obtaining a written guarantee, or who subscribe in terms of Rule 18. The words **DEPOSITOR OF** or **SUBSCRIBER OF** and the date can be written or stamped on the back of the card. Of course there is no reason beyond avoiding a multiplicity of cards and too much red-tape, why a library should not provide separate forms for every class of applicant, with differently coloured cards, etc., but it seems quite unnecessary, unless there are special local circumstances to be considered.

425. Tickets.—In Chapters XIII. and XXIX., Sections 205-213, 441-443, various forms of borrowers' tickets are shown for use with indicators and card charging, but the forms shown in Sections 443, 445 (Figs. Nos. 159, 161) are the most suitable for working in connection with the economical system of card charging used in non-indicator libraries. Another form is shown below (Fig. 144) for libraries in which borrowers retain their tickets when they have no books on loan. They are made with cloth backs to fold across, and the one with the clipped corner is a good form to adopt for students' or extra tickets available for non-fictional works only. It is not absolutely necessary to keep a record of book numbers on the readers' cards, as indicated on the form shown in Sections 444-445, and the variety shown on the next page is not ruled for this purpose:—

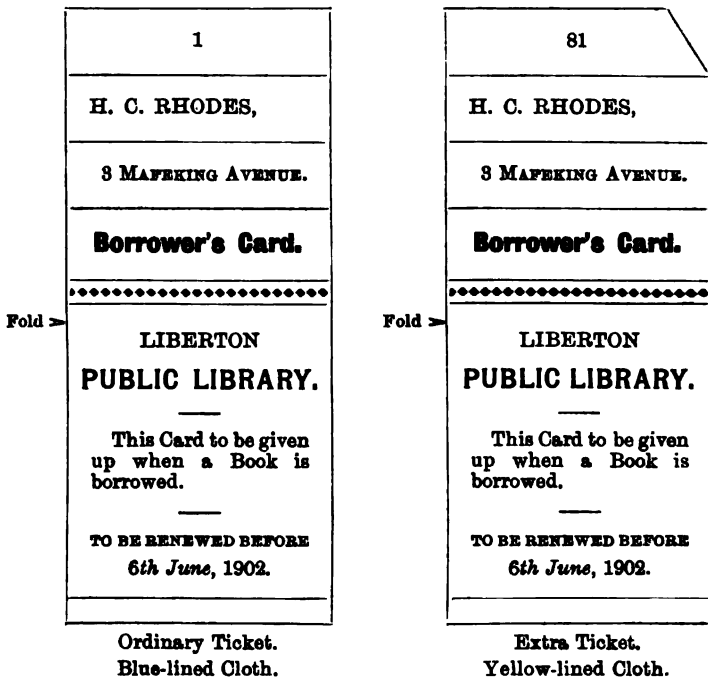

FIG. 144.—Borrower's Card (Section 425).

426. The plan of issuing DUPLICATE or STUDENTS' tickets available for non-fictional works only, in addition to an ordinary ticket available for all classes of literature, first became popular in Britain in 1893, and arose out of a suggestion made by Mr. J. Y. W. MacAlister at the Library Association Conference at Aberdeen. In America this is generally known as the "Two-Book System," and it became very widely adopted after 1894. There are decided advantages about the plan of allowing borrowers to have two books at a time, and there is no doubt it greatly enhances the value of the public library to many people. As indicated by Rule 19, Section 419, special privileges are recommended to be extended to school teachers, who ought to be allowed any number of books, within reason, required for their special and important work of education. We can see no

Sec. 428] **REGISTRATION OF BORROWERS.**

objection to allowing special privileges to all earnest students engaged on special lines of research, provided no injustice is done to the general work of the library or to students similarly engaged. Certainly it is better to lend a real student half a dozen or more books at a time than to have these books lying idle at the library, or collecting dust for the future annoyance of the librarian. Of course, in libraries with more readers than books, if there are any, extra tickets will require to be issued with caution, but in all large libraries the privilege can be extended without fear or hesitation.

427. REFERENCE LIST OF AUTHORITIES :—

Birge, E. A. The effect of the "Two-Book" system on circulation. *Lib. J.*, 1898, p. 98.

Bolton, C. K. Bettering circulation in small libraries. The "Two-Book" system. *Lib. J.*, 1894, p. 161.

Cotgreave, A. Disadvantages of the two-ticket system. *L.*, v. 8, p. 260.

Jones, G. M. Cards for the "Two-Book" system. *Lib. J.*, 1895, p. 168.

MacAllister, J. Y. W. New ways of keeping down the issues of fiction. *L.*, v. 6, p. 236. ("Two-Book" system.)

Miner, S. H. The "Two-Book" system. *P. L.*, 1897, p. 173.

For list of abbreviations see Section 88.

428. Registration.—All borrowers' tickets should be numbered in a progressive series, and the same number should be given to the same borrower as long as he or she remains connected with the library. This prevents overlapping and the clumsy method of numbering continuously up to a certain limit and counting off the early numbers; a doubtful way of ascertaining the total number of actual borrowers at any given time. A number register should be obtained ruled as on the next page.

In this each borrower is entered as he joins, receiving the first vacant number, which is also carried on to his voucher and ticket. The column is chosen which represents the year in which his ticket expires, and against the number is written the borrower's name, and under it the month and day when the ticket expires. The holder of a given ticket can be ascertained very rapidly by this method, and time-expired or dead ticket-holders

| No. | 1901. | 1902. | 1903. | 1904. | 1905. | 1906. | 1907. |
|-----|------------------------|------------------------|-------|-------|-------|-------|-------|
| 1 | H. C. Rhodes June 4 | H. C. Rhodes June 6 | | | | | |
| 2 | P. Krüger June 4 | J. Burns July 10 | | | | | |
| 3 | | | | | | | |
| 4 | | | | | | | |
| 5 | | | | | | | |
| 6 | | | | | | | |
| 7 | | | | | | | |
| 8 | | | | | | | |
| 9 | | | | | | | |

FIG. 145.—Borrowers' Number Register (Section 428).

can be counted off without trouble. But it is necessary to mark or qualify the entries in order to do this. An easy way to indicate an expired ticket is to mark the register with a blue tick (✓) as shown above (No. 2). These expired numbers should be given to new borrowers, so as to keep the register filled up and complete, and at the end of a given period, when it is time to ascertain the number of "live" or actual ticket-holders, it is only necessary to count the blue ticks, and deduct their number from the last number of the series, in order to obtain the exact number of current borrowers. A number register book ruled as above will last for a number of years. It is not necessary to print the progressive numbers or years, and it will facilitate counting operations if fifty numbers are allowed for every page. Duplicate or special ticket-holders numbered in a separate series should be entered in a separate book, and juvenile ticket-holders can be treated in similar fashion.

429. To prevent the possibility of a number of tickets being obtained by the same individuals, all tickets should be issued

Sec. 430] REGISTRATION OF BORROWERS.

from the central library of a town, and such tickets should be made interchangeable. There does not seem to be any advantage attached to issuing tickets from branches separately, or in confining the residents in particular localities to a local branch. The residents in a town should be entitled to use any of the libraries, and a central registration of borrowers is therefore essential. Of course, the actual distribution of the tickets can

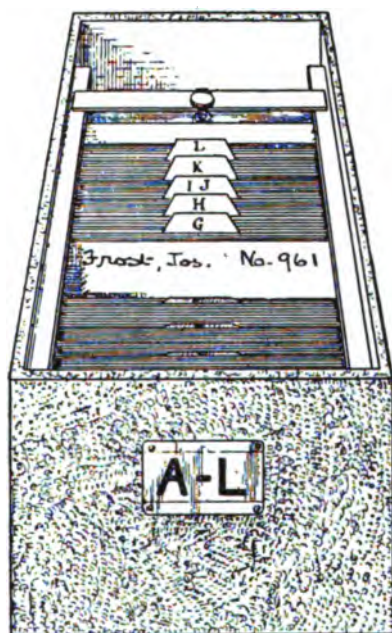

FIG. 146.—Borrowers' Voucher Tray (Section 430).

take place through the branch where application was made, but after that a ticket should be universal.

430. When the borrowers' vouchers have been duly checked, numbered, and the tickets have been written out, they should be filed in alphabetical order of the borrowers' surnames in properly guided trays, supplied with all necessary angle blocks, etc., as in the case of charging and card-catalogue trays. These

form the alphabetical index to the borrowers, while the borrowers' number register supplies the numerical side. Thus any question regarding borrowers can be answered without delay. It is not necessary to keep an alphabetical index of guarantors if the electors' roll is marked as previously suggested.

REFERENCE :—

Registration of Borrowers. Symposium by American librarians. Lib. J., 1890, pp. 37, 74.

CHAPTER XXIX.

ISSUE METHODS.¹

431. When Burns, the poet, was acting as a kind of budding librarian at Friars' Carse in Dunscore Parish he emitted the following ponderous reflections which would, in our own time, pass muster bravely in the annual report of any library committee: "To store the minds of the lower classes with useful knowledge is certainly of very great importance, both to them as individuals and to society at large. Giving them a turn for reading and reflection is giving them a source of innocent and laudable amusement; and besides raises them to a more dignified degree in the scale of rationality." In pursuance of the idea that to give a "turn for reading" is a good thing, Burns, in association with Robert Riddel, of Glenriddel, "set on foot a species of circulating library on a plan so simple as to be practicable in any corner of the country". The details of the management are somewhat meagre, but we gather that the method of registering borrowed books was not only primitive, but devoid of all those accessories which have been found necessary in more modern days. "At every meeting all the books, under certain fines and forfeitures, by way of penalty, were to be produced; and the members had their choice of the volumes in rotation. He whose name stood, for that night, first on the list had his choice of what volume he pleased in the whole collection; the second had his choice after the first; the third after the second; and so on to the last. At next meeting, he who had been first on the list at the preceding meeting was last at this; he who had been second was first; and so on." Under

¹The greater part of this chapter is taken from a series of articles contributed to the *Library World* by the Author.

such a rota we may be morally certain that the last man invariably got Blair's *Sermons*, which formed an item in the library, along with other ponderous works, and what Burns calls "a good deal of trash". The point to be noted in this account of an early circulating library is the evident effort to give members equal rights and privileges. Nothing is left to the care of chance, which forms such a strong element in modern library work. Burns knew, if he had the good fortune to lead off the rota, that Blair's *Sermons* would inevitably fall to his lot whenever he made the terrific descent from *dux* to *dubie* arranged for by the rules, and he could brace himself up accordingly. The principle of first come first served was not recognised in these early joint stock libraries, but rather a rigid application of a quaint Draconic law which ensured that no one should escape his chance of improvement by avoiding the more solid contents of the library. Endless possibilities are opened up by this system of rotational choice, but we need not pursue the subject further at present. It is enough to have shown that at one time book issues and registration were associated with a certain amount of mild coercion or guidance in selection, which limited conditions made more possible than now. The question of regulating the choice of books does not enter very much into the methods invented for keeping a record of their issues, and our remarks are merely intended to show that a century ago, and indeed long before, there was a more direct attempt made to maintain some control over the public reading. In Burns' time this was secured by a simple mechanical process, based on rotary movement, and, as we shall show later, mechanical means of some kind have always been used to register the issues of books.

432. The practice of the early monastic libraries in lending books was, to a great extent, based upon the principle that borrowers, while having equal privileges, were expected to make the best possible use of the books. In other words, as we have seen in the case of the library with which Burns was connected, books were issued in such a way as to compel borrowers to take in their turn some of the purely didactic

works. That this idea should have lived through hundreds of years, down even to the early part of the present century, says much for its vitality and the soundness of its basis. Most of the monasteries issued books to the brethren but once a year, and these were retained till the following year. This practice had its origin in the Rule of St. Benedict, which, besides enjoining the issue of books in this way, prescribed "that one or two seniors should be appointed to go round the monastery at the hours when brethren are engaged in reading, in case some ill-conditioned brother should be giving himself up to sloth or idle talk, instead of reading steadily". When these books were returned after a year's absence, the borrower was asked questions as to the contents of the book he had been reading, and if unable to satisfy the abbot, or other superior, that he had been studying with attention, he was compelled to take back the same book and read it over again. If the borrower satisfied the examiner, he was allowed to choose another book. Books lent were entered in a *Brevis Librorum*, or register, which appears to have corresponded with some of the varieties of modern ledgers or day books. At the annual distribution, which was also a stock-taking, these register entries would no doubt be marked off and fresh entries made of the new borrowers and the books issued. It is a curious commentary upon some recent claims to the invention of the so-called "Two-Book" System, to find that in the Carthusian monasteries the issue of two books at a time was permitted.

433. In much later times, long after monasteries had ceased to be centres of educational influence, we find the same desire to combine the lending of books with the improvement of the reader, and a marked determination to make the librarian or custodian strictly responsible for the works in his care, even to the extent of punishing him for some trivial neglect. No doubt the present attitude of those librarians who exercise a jealous and grudging method of doling out books has been evolved from the policeman-like duties thrust upon earlier keepers of books. The habit of regarding even potential borrowers of books as freebooters for hundreds of years has become crystallised

into a positive belief, which it is impossible to eradicate from some minds. Thus have grown up all kinds of systems designed to make book borrowing as difficult as possible, and the actual registration a cast-iron certainty. The Rev. Mr. Kirkwood, in his projects for establishing "Liberaries intended for the Highlands," seems to have been dominated by his intense anxiety on behalf of the books, their keepers and their borrowers; induced, we may hope, by considerations of locality as much as anything else; though it is more likely his rules simply reflect the general spirit animating library administration in his time. In his 1699 tract it is laid down that "The keeper of the bibleothek must find caution to be faithful in keeping the books and in preserving them from all inconveniences". In the one dated 1702 it is proposed "That the books be kept under lock and key, in good and strong presses," and "That each press have two locks and two keys, whereof one key is to be in the hands of the minister and the other of the schoolmaster". Suspicion must have been rampant when even the parish minister could not be trusted alone in the library! The following regulations as to borrowing throw additional light upon the methods considered wise in the past; and they show that the Presbyterian conception of library management differed but little from the Monkish:—

7. "That he who borrows any book, consign a fourth part more than the real value of it; thereby to prevent the turning the Libraries into Book-sellers' shops."
8. "Besides, the borrower of any treatise ought to enter his name into a book of the Library to be provided for that purpose, together with the time in which he is to restore it, upon pain of forfeiting the money consigned. This seems likewise needful to prevent the embezzelling of the books."
18. "That they who are entrusted with the charge of the books, give good security to leave them in as good case as they were in when they were first entrusted with them."

26. "No book shall be lent unless the person who comes for it bring with him conveniencies to carry it without damage."
27. "No person at one time shall have more than two books."
28. "If any do neglect to return any book by the time limited, the Librarian shall take care to send him notice, the charge of which message he shall pay, besides the forfeiture."

Apart from the dim anticipations of modern library rules contained in the regulations concerning overdues, fines, etc., the most interesting extract from Kirkwood's tract is that showing the method of charging, which was a form of ledger in which the borrower had to sign a receipt for his book, together with an undertaking to return it at a certain time.

We have thus, at some little length, brought out the fact that the earliest form of registration used for loaned books was the ledger, and to the various forms of this we propose to devote the next section.

434. The very earliest type of ledger used in connection with lending libraries was a kind of receipt book, in which were entered particulars of the book borrowed, and this register was signed by the person who took away the book. We have not been able to find an actual specimen of this type of ledger, but believe it was simply an ordinary blank volume, in which the entries succeeded each other without columns or other classified features. When libraries were small and borrowers few in number there was no need for elaboration in the accounts of books issued and returned. As books multiplied and libraries increased a gradual extension would occur all round, and the necessity would arise for some ready method of distinguishing books returned from those still on loan. Thus would the column method of ruling come into existence, with its many varieties and uses. One form was designed to show, by the presence or absence of a signature, whether books were out or in. Its ruling was as follows:—

| Date. | Title of Book. | Received. | Returned. |
|----------------|---------------------|--------------|-----------|
| 1794 Dec. 6 | Blair's Sermons. 3 | Robt. Burns | R. Riddel |
| " | Fergusson's Rome. 2 | John Lapraik | |
| " | Robertson's America | T. Coltart | R. Riddel |
| " | Roderick Random | A. Johnston | |
| Dec. 19 | Ramsay's Evergreen | Gavin Scott | R. Riddel |
| " 27 | Boston's Crook | Alex. Geddes | . |

FIG. 147.—Issue Ledger (Section 434).

Overdue books could easily be detected by a register of this kind, on simply scanning the column of returns, filled up by the librarian. This is by no means a bad form of ledger for private libraries, as book owners could get borrowers to declare their liability indirectly under the pretext of preserving their signatures as valuable autographs.

435. With the advent of subscription and public libraries fresh requirements arose, and the forms of charging ledgers entirely changed as regards the information recorded, although remaining the same in registering a day's work in consecutive order, instead of the issues of a certain book or to a certain reader. A very common form, which is still used in some libraries, was ruled to give a variety of facts (Fig. 148).

This style of ledger is worked very easily. Every book has a label pasted inside one of the boards, ruled to show the progressive number, date of issue and borrower's number; also, sometimes, a column is provided for the date of return, but this is not necessary. The borrower presents his card and a list of the books he would like, giving numbers and classes, and the librarian goes over the shelves till he finds one of the marked works. He then proceeds to the ledger and enters the work in the first vacant line, carrying on to the book label the progressive number against which the entry is made in the ledger, the date and the number of the borrower's card. The book is then given to the borrower along with his card. When the book comes

back, the date and progressive number direct to the exact place in the ledger, and the date of return is written or stamped against the ledger entry. In actual practice books are very seldom marked off at the moment of return, owing to the time

Thursday, 1st September, 1898.

| Pro- gressive No. | Title of Book. | Class Letter. | No. | No. of Vols. | Date of Return. | Name of Borrower. | No. of Card. | Fines. |
|-------------------------|-------------------|------------------|-----|--------------------|-----------------------|-------------------------|--------------------|--------|
| 1 | | | | | | | | |
| 2 | | | | | | | | |
| 3 | | | | | | | | |
| 4 | | | | | | | | |
| 5 | | | | | | | | |
| 6 | | | | | | | | |

FIG. 148.—Issue Day-Book (Section 435).

taken, and this is one of the weak points of the system. Some librarians do not start to mark off the returned books till there is a distinct lull in the service, and in some cases they are not marked off till the end of the day. Thus a large number of

Friday, 2nd September, 1898.

| Pro- gressive No. | Book, Class and Number. | Vols. | Date of Return. | Borrower's Card. |
|-------------------------|-------------------------|-------|-----------------|---------------------|
| 1 | | | | |
| 2 | | | | |
| 3 | | | | |
| 4 | | | | |

FIG. 149.—Condensed Issue Day-Book (Section 435).

popular works are constantly out of circulation, and mistakes are very liable to occur when an assistant *does* reissue a returned book before it is marked off. Slurred or imperfect entries in the ledger, caused by hurried writing, are a constant

source of annoyance with nearly every form of day ledger, and the more columns of particulars are required to be filled in, the greater is the likelihood of error. Ledgers of a later pattern have been designed to get over the waste of time and liability to mistakes caused by the multiplication of details, and the ruling in Fig. 149 will give an idea of the simplified style.

The book labels remain as before, but, as will be seen, the amount of writing at the moment of issue is considerably reduced. In some libraries the Fines column is retained, and in others the column for number of volumes is omitted, each separate volume being entered to a different progressive number, so that at the end of the day the total number of volumes issued would be automatically ascertained without casting. In both these forms of ledger, or rather journal, overdue books have to be discovered by a close scanning of every page for blanks in the "Date of Return" column, and as this must be done regularly all over again every week a considerable amount of time is consumed. Again, the reading of individual borrowers can only be traced with great trouble, while the whereabouts of any given book is very difficult to ascertain without, in many cases, wasting much time scanning page after page. On the other hand, there is no expensive apparatus required to work the lending department, while the ledger is a fairly permanent record of the operations of the library. These are the two best known and most extensively used forms of ledgers in journal form, and we shall next consider the varieties which have been designed to effect other purposes.

436. In many of the proprietary and commercial subscription libraries the plan of keeping an account with every subscriber of books on loan was common, and is, to a certain extent, still used, though the more usual practice is to keep such records on cards. There are certain obvious advantages in keeping separate accounts with every individual subscriber, especially in cases where several volumes are loaned at a time. In commercial subscription libraries this method is indispensable, because it is more necessary to know how *many* books a subscriber has, than

what books he has ; while questions affecting renewals of subscriptions, etc., can be better answered by a single page of a ledger than if scattered over a variety of different records. This form of business ledger, in which the subscriber's record is kept, was ruled to show the following particulars :—

JOHN SMITH, 15 BRUNSWICK AVENUE.

| Date. | Title of Book. | No. | Date of Return. |
|------------------|----------------|------|-----------------|
| 1898. Oct. 10 | Hand of Glory | 596 | Oct. 27 |
| „ | Unknown Russia | 8964 | |
| Oct. 27 | Martha and I | 5672 | |

FIG. 150.—Borrowers' Ledger (Section 436).

In public libraries, where every book is properly numbered, the need for the "Title of Book" column would not arise, and no book label is required, unless to stamp the date of issue. The chief defects of this personal form of ledger are that it provides no means of showing the whereabouts of any given book ; makes the detection of overdues difficult ; and has the same drawbacks as to marking off which are associated with all ledgers in book form. This form of ledger also requires a special day issue-sheet or book, in which to preserve a record, for statistical purposes, of the books issued.

437. In public lending libraries it is generally recognised that accounts kept with the book issued, instead of with the borrower who has it, are much more helpful and exact than other forms. Although now almost invariably kept on cards, this form of ledger was formerly kept in book form. A specially ruled ledger was procured, and its folios numbered consecutively to correspond with the numbers, accession or shelf of the books of the department. Each book was given a folio, so that a large library might require several ledgers, while, if kept in classified order, there would be required as many ledgers as classes. The ruling was as follows :—

HOPE.

PRISONER OF ZENDA.

F 9432.

| Date of Issue. | Borrower's No. | Date of Return. | Date of Issue. | Borrower's No. | Date of Return. |
|-----------------|----------------|------------------|-------------------|----------------|-----------------|
| 1898. July 6 | 8276 | 1898. July 19 | 1898. Aug. 27. | 2641 | |
| July 19 | 268 | Aug. 10 | | | |
| Aug. 11 | 5681 | Aug. 18 | | | |
| Aug. 18 | 2211 | Aug. 26 | | | |

FIG. 151.—Book Issue Ledger (Section 437).

The chief objection to this form of ledger when kept in book form is the rapidity with which the space appropriated to popular books gets filled up. To get over this difficulty we have seen pencil entries used, which could be obliterated when the page was filled, or written over again in ink, but, at best, this is a slipshod way of overcoming a permanent defect. Overdues have to be searched for page by page, as in all the other varieties of ledger, and the "marking off" trouble also remains. Separate daily issue-sheets must also be used. With all the varieties of ledger described, save those kept in the form of day books or journals, some method of keeping a separate record of the issues is necessary. As other systems of charging also require such records, it will, perhaps, be more convenient to describe them all together.

438. The great objection to all charging ledgers in book form is their want of movability or adjustability. The entries when once made are fixed, either in a running sequence under a date of issue, a borrower's name, or a book's title. If, for any purpose, it should be desirable to manipulate the entries, in order to secure greater accuracy, or some definite record of a special kind, the book ledgers will not lend themselves to this sort of treatment. There is no kind of movability possible, and questions which might be answered readily enough if entries were movable and separate, cannot be put to any issue record in volume form. Chiefly because of this, the slip or card methods

of charging have been introduced, which enable registration to be conducted in a variety of ways for different purposes. It is impossible to say when or where cards were first introduced, but as they have been used for commercial purposes for years before the public library system was thought about, it follows that many minds must have discovered the utility and convenience of movable entries. There are many varieties of card or slip charging in existence, and innumerable methods of working or applying them. Movable entry systems are in every respect the most interesting, not only because they present greater possibilities to the ingenious mind, but because they are more scientific and more natural.

439. To obtain the advantages of movability of entry, various methods of charging books on temporary slips have been devised. These are nearly all of American origin. Indeed, it may be safely said that they are *all* of American origin and use, as we cannot recall the case of a single British library which uses temporary slips, save as application forms. There are many different methods of using these slips, and we propose to describe the most interesting. Like ledgers, these slips can be used to keep a record of issues, either with the book numbers or the borrowers. When used as a register of borrowers, the plan is worked thus: Trays are provided in which are placed a series of cards (4 inches \times 2½ inches) bearing the names of the borrowers in alphabetical or numerical order. The trays are constructed in compartments into which the cards fit snugly, but so as to slide about easily when placed upright on their edges. Blank slips of thin manila or other paper are provided, of a size rather less than the borrowers' cards (3 inches \times 1½ inch). These may be kept on the counter for public use or behind it for staff use, this depending upon whether the slips are filled up by the borrower or the assistant. In any case, the book number is written on a blank slip, the date of issue is stamped on it, and it is *immediately* put in the tray, behind the card representing the borrower. In most cases, however, the borrower's number is also added in view of misplacements, this information being obtained from his membership card. This is

the simplest form of slip register, and is only suitable for small libraries of the subscription kind, as it shows no overdues, and makes no provision for the speedy detection of the whereabouts of any particular book. The record of a day's issues could be kept on a classified day issue-sheet. Another method which is somewhat superior was used in the Public Library of Chicago over twenty-five years ago, and is described by the late Dr. W. F. Poole in the *United States Government Report on Public Libraries*, 1876. In this system the reader simply hands in a list of wants, the assistants doing everything else. When a book is found which is marked on the borrower's list, the title is struck out and the list returned. The assistant then prepares a blank slip (2 inches \times 2½ inches) as follows:—

| |
|--|
| <p>17,259</p> <p>G 534</p> <p>March 25th</p> |
|--|

FIG. 152. —Book Issue-Slip (Section 489).

This represents the borrower's number, the press mark of the book issued, and the date of issue. The date of issue is also stamped upon the borrower's card, but not upon the book. The slips are arranged in numerical order of borrowers at the close of the day's work, and, when the necessary statistics are compiled, they are placed in a compartment of a tray, provided with sliding numbered blocks to indicate the days of the month. When

a book is returned the date on the borrower's card directs to its place on the register, the slip is withdrawn and destroyed, and another book is issued. By this method overdue books show themselves automatically, as each receding day gets weeded out by the return of books, and in course of time all the slips for overdue books become assembled in one place. Its main defect is the difficulty attending the tracing of any particular book. If the question is asked, "Who has 'G 534' and how long has it been out?" there is no ready means of answering it. With this system a somewhat novel, but rather unreliable, method of

| | |
|--|-------|
| NAME: John Adams, | |
| ADDRESS: 596 Washington Street. | |
| | |
| G | 9621. |
| F | 821. |
| G | 8216. |
| A | 311. |
| B | 211. |
| G | 6111. |

FIG. 153.—Call Slip (Section 439).

recording the number of books issued in each class was used. A tin box was made, divided into compartments of equal size and covered all over, save for a small hole or slot over each compartment, and each of these holes was marked with a class letter. When a book in class G was issued, a pea was dropped into the corresponding compartment, and at night these compartments were separately emptied and the day's issues counted by the number of peas found in each. This somewhat primitive method was in use, when the writer was at Chicago, in 1893.

Another variation of this slip method was used at Boston Public Library, and others in several parts of the United States. Printed slips of a handy size were provided, with spaces set apart for the borrower's name, address and number, in cases where numbers are applied to readers. On these slips the borrower filled in his name, address and a list of book numbers. This form of slip might then appear like Fig. 153.¹

Supposing the assistant finds F 321 the first book in, he erases all the other numbers, stamps the borrower's card with the date of issue, and gives out the book. The slips are then arranged alphabetically in order of borrowers' names, and placed in the dated compartment of a drawer or special tray, when the usual statistics are obtained. On return, the date on the borrower's card directs to the proper tray, and to the slip, which is then removed and destroyed, the date on the borrower's card being cancelled at the same time. In this system overdues declare themselves, but, as at Chicago, the whereabouts of particular books are difficult to ascertain.

440. It appears from Miss Plummer's report on "Loan Systems," contributed to the World's Library Congress,¹ that the useful method of arranging these temporary slips in order of book numbers, instead of borrowers or borrowers' numbers, has been very seldom tried in America. Yet the advantage is perfectly obvious, as it enables the whereabouts of any book to be readily discovered, which is the question most frequently required to be answered. None of the slip systems is desirable if permanency of record is a consideration, apart from which there are certain difficulties in the way of handling and arranging thin paper slips which detract very considerably from their advantages. In reference libraries the temporary slip is the usual form adopted, as it serves only for a single day, but where such slips have to be preserved for weeks, in some cases, difficulties of storage arise. The slip system is gradually dying out in favour of the more permanent and useful card system, which not only gives better results, but

¹ *United States Education Report, 1892-1893, vol. i., p. 902.*

has points in connection with greater clearness and permanency of record, which renders its use much more generally satisfactory.

441. There have been numerous systems devised for recording issues of books from public libraries, but in none have so many variations been introduced as in the great group using cards as a basis. Not only do card methods exist in plenty everywhere, but there is hardly any limit to be put to the variety of ways in which they can be used. Without describing in detail every system, it will nevertheless be interesting to select and describe typical plans from among the more practical varieties, as representative of each particular group. The fundamental idea of all card systems of charging is that a book shall be represented by a movable card, which can be stored in various ways when the book is on the shelf, and used to register or charge the book, when issued, to its borrower. On a previous page we have shown a ledger method of charging to the book instead of to the borrower, and this is no doubt the prototype of the modern system of separate cards. At any rate, we regard the simple book-card kept in drawers or trays as the most elementary of the card systems; and, when not used in connection with movable dating blocks, this is substantially the same as the ledger already described, except that, when a card becomes surcharged with entries, it can easily be removed and a fresh blank added. Such cards may be ruled exactly the same as the ledger, when not removed from their places; but it is so very seldom they are kept in a fixed numerical sequence that we shall pass on to the more common and decidedly more advantageous method of using the cards as movable entries. The defects of the fixed sequence of cards are the same as in the ledger; overdues cannot be readily found, and it is necessary to keep an additional record of some kind at the moment of service, for statistical purposes.

442. When cards are used as movable entries, there is no need to keep a column for showing date of return; and, before describing a method of working, the following specimen ruling for a card is given:—

| | | | |
|--------------------|---------|------|--------|
| F 9432. | | | |
| HOPE. | | | |
| Prisoner of Zenda. | | | |
| 8276 | Jul. 19 | 2641 | Nov. 6 |

FIG. 154.—Book Issue-Card (Section 442).

The first and third columns may be used for the borrowers' numbers, and the second and fourth for dates of issue, as shown above, or all four columns may be used for borrowers' numbers. The backs of the cards should be ruled the same, without the heading. These cards are kept in a strict numerical order of progressive numbers in trays or drawers. When a book is chosen by a borrower, the card representing it is withdrawn from its place, the borrower's number and date of issue entered, the date of issue stamped on the date label of the book, and the transaction is complete when the book-card is placed in a tray, or behind a special block bearing the date of issue. At the end of the day the cards are all sorted up in numerical order, as far as possible, the statistics made up from them, and they are then put away in the dated issue trays, or behind date blocks in drawers. When a book is returned, its date and number direct the assistant to the exact number of the book-card, which is withdrawn, and at leisure replaced in the main sequence. No other marking off is necessary, and the book is immediately available for issue. Overdues gradually declare themselves, as day after day passes, and the cards for books in circulation diminish in number as returns are made. This is card charging of a simple kind, and it forms the basis of all the more elaborate and, perhaps, more scientific systems. The chief drawbacks of the plan, from some points of view, are the difficulty or undesirability of storing the cards apart from the books,

and the fact that the borrower must retain his card while he has a book. To overcome both difficulties, Mr. Virgo, ex-Librarian of Bradford Public Library, devised an ingenious method whereby both points were effectively met. This system dates from about 1873, and has been described several times, but more particularly on page 25 of Brown's *Handbook of Library Appliances*, 1892. Each borrower is supplied with a card of the usual sort, and also with a linen one in the form of a pocket, which is kept at the library in numerical order along with all the others. This pocket-ticket bears the borrower's name, address, etc., as below :—

| | |
|----------------------------------|---------------------------|
| No. 1807. | 13th August, 1891. |
| BORROWER <i>John Smith.</i> | |
| AGE 25. | OCCUPATION <i>Clerk.</i> |
| ADDRESS <i>24 Darley Street.</i> | |
| GUARANTOR <i>Wm. Jones.</i> | |
| AGE 40. | OCCUPATION <i>Grocer.</i> |
| ADDRESS <i>32 Kirkgate.</i> | |

FIG. 155.—Virgo Pocket-Ticket (Section 442).

The other card, retained by the borrower, is used for purposes of identification only. In every book, on one of the inner boards, is attached a linen pocket, with a ruled table of months for dating. Inside this pocket is a movable book-card, on which are written the author, title, number and class of the book represented. This is ruled as in Fig. 156 on the next page.

When a book is issued the book-card is withdrawn from the book and placed in the borrower's pocket ticket, which has previously been selected from the sequence, and the date written or stamped upon the pocket inside the book. Statistics are made

up from these cards in the usual way, and the conjoined pockets and cards are then arranged in numerical order of book-cards and placed in a drawer or tray bearing the date of issue. The return is made, as before described, by the date on the book and its number directing to the dated tray, and overdues declare themselves automatically. The principal objection that can be urged against the system seems the unnecessary provision of two borrowers' cards. The identification card does not seem vital to the successful and safe working of the system, and its abolition would also disperse with the hunt for the pocket-card in the numerical sequence. This is one of the earliest of the

| |
|-------------------------------------|
| BOOK No. <i>B 21.</i> |
| CLASS <i>E.</i> |
| TITLE. |
| <i>East Lynne.</i> |
| AUTHOR'S NAME. <i>Mrs. H. Wood.</i> |

FIG. 156.—Book-Card for Virgo System (Section 442).

pocket-card systems I have been able to discover, and it is the original of many others which have been based upon it during the past thirty years. The cards used in the original system differ considerably from those figured above, but the method of working remains the same to-day as it was in 1873.

443. The ordinary card method used in the libraries of the United States has been described very frequently, so that a brief account of one of its most typical forms will serve for all practical purposes. The method bears a considerable resemblance to the Bradford system previously mentioned, but in many details differs very materially. In every book, generally on the inside

of the back or front cover, is fastened a manila pocket designed to hold a special book-card. These pockets are made in many different forms, some of them ruled to show dates of issue and other particulars. The diagram (No. 157) will give a good idea of its appearance:—

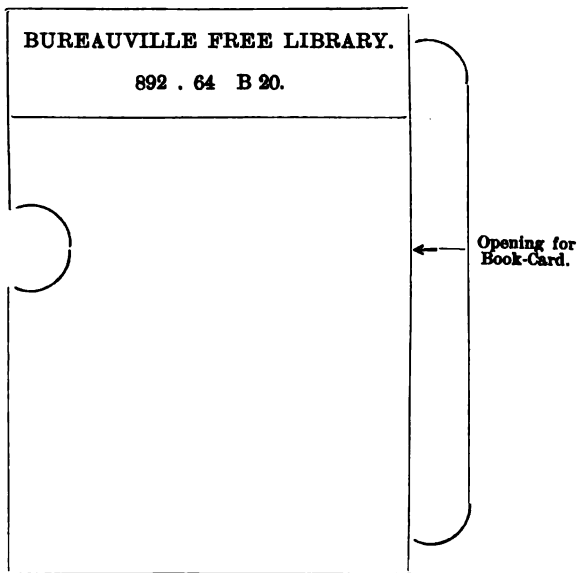

FIG. 157.—American Issue Pocket (Section 443).

While the book is on the shelf its card is contained in the pocket, which bears the book number, and is generally ruled to show borrowers' numbers and dates of issue (Fig. 158). Each borrower has a card, which he usually retains, ruled to take book numbers and dates of issue as in Fig. 159.

The method of service is something like this: the borrower goes to the library with his call list and card and hands both to the assistant, who proceeds to the shelves and finds the first book noted on the call list which may be in. He, or more generally she, next carries the book number and date on to the borrower's card, and the borrower's number and date on to the

book-card, removing the book-card from the pocket, placing therein the borrower's card, and issuing the book. In many libraries the date of issue is also stamped on the pocket inside the book; in others, the dated borrower's card in the pocket is regarded as sufficient. The book-cards are sorted in order of book numbers in dated trays when the issues have been compiled, and when a book is returned the date on the borrower's

| | | | |
|-----------------|--------|--|--|
| 892 . 64 B 20. | | | |
| DEWEY'S MANILA. | | | |
| 4618 | Ja. 10 | | |
| 16491 | Ma. 6 | | |

FIG. 158.—American Book-Card for Pocket System (Section 448).

card directs to the tray, and the book-card is removed and replaced in the pocket. This system, with innumerable variations, is the standard system in the libraries of the United States. A variation of this was introduced by Miss Nina E. Browne, of the Library Bureau, in 1895,¹ in which the chief differences were the provision of a borrower's card in the form of a pocket, and the discarding of much of the recording which makes the ordinary

¹ *Library Journal*, May, 1895, "An Indicator-Charging System," *Transactions*, p. 142.

American system slow and liable to error. The book-card in this system is simply removed from the book pocket and placed in the borrower's card pocket, and so the charge is made. This is substantially the Bradford method on a somewhat smaller and neater scale. Another interesting variation is that described by Mr. Jacob Schwartz at the International Library Conference of 1897. This is very much older and just reverses the principle of Miss Browne's method, and also dispenses with the pocket

| | | | |
|-----------------------------------|-------|--|--|
| Card expires . . . Mar. 10, 1900. | | | |
| 16491. | | | |
| BENJAMIN FRANKLIN, | | | |
| 396 West 10,961 Street. | | | |
| 892.64 B 20 | Ma. 6 | | |

FIG. 159.—American Borrower's Card (Section 448).

inside the book. The book-cards in the form of pockets are kept, in numerical order, in trays, accessible to the public or otherwise as may be decided. The borrower's card is made to fit the pocket of the book-card. When a book is issued the book-card is selected from the tray and the borrower's card placed in it, after having the date of issue stamped on the back. The following diagram will give an idea of the appearance of this conjunction of cards :—

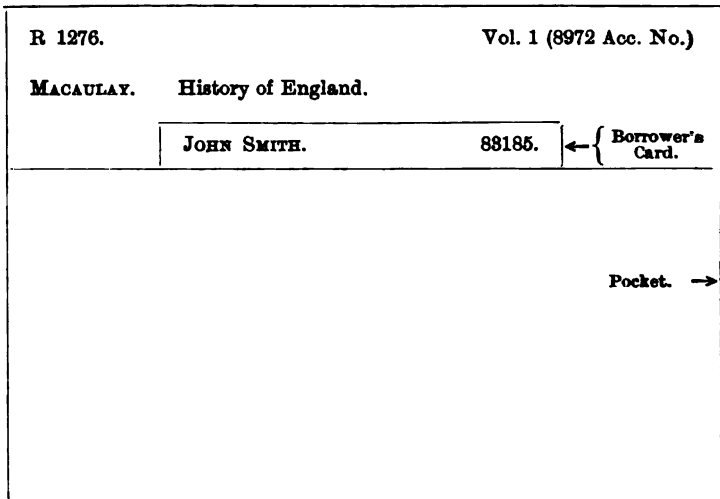

FIG. 160.—Schwartz Card and Pocket Combined (Section 443).

These conjoined book and borrower cards are sorted up in the usual way in drawers or trays behind date guides.

444. Of late years the pocket system has become very popular in the United Kingdom, and is now being used not only as a separate method, but also in connection with, or as an adjunct to, many of the indicators. Most of these are very similar to the Schwartz system described above, but, as in the United States, many varieties exist. A very good method for a small library is used at the Holborn Public Library, London. Here the book cards are ruled on one side with columns to show borrower's numbers, each class having different coloured cards. A linen pocket is fixed to the back of each book-card to contain the borrower's card when a book is issued. The working is perfectly simple. When a book is issued the borrower's number is written on the book-card, which is kept inside the book. The borrower's card is then placed in the pocket of the book-card and the charge is complete. Afterwards the book-cards are sorted according to classes and numbers and arranged in trays behind blocks showing the dates of issue. Overdues declare themselves

automatically, as with most card systems. An earlier variety, on somewhat similar lines, was introduced at Penzance Public Library in 1893, the chief difference being that the book-cards are kept in separate sequence in trays to serve as an indicator to the staff, while the pockets are entirely separate, representing neither book nor borrower, but being simply a medium for uniting both. These separate pockets are made of buckram and are kept by themselves. When a book is issued its card is withdrawn from the sequence and placed with the borrower's card in one of the loose buckram pockets, and thus the charge is made. At Penzance the borrower's number and date of issue are carried on to the book-card, but even this is not necessary when the date of issue is stamped on the book label and the conjoined cards are arranged in trays in dated compartments.

445. The card-charging method used in connection with open access, and also alone, or in conjunction with indicators, is a loose pocket system ; the chief variation from the Penzance plan being the provision of manila instead of buckram pockets, smaller and more uniform cards, and special forms of charging trays. This method has been very fully described in *Greenwood's Library Year Book*, 1897 (pp. 65-75), so that it is not necessary to do more than briefly note its principal features. Each book is represented by a manila card (about 4 × 2 inches) ruled on both sides to take borrower's numbers and dates of issues. Every borrower is represented by a card (as figured in Sections 425 or 445). When a book is issued its card is taken from the tray, and, with the borrower's card, is placed in a loose manila pocket, the date of issue is stamped on the date label inside the book and the borrower receives the volume. It is customary in most open-access libraries to hand the borrower his card when his book is discharged. If he does not want another book at the moment, he retains his card for the future, but if he does want another he selects one in the usual way, and hands it and his ticket to the assistant at the exit charging wicket, where both are registered very rapidly by simply selecting the book-card and placing it with the borrower's card in a loose pocket, as already described. In some libraries the conjoined book and

borrower cards are simply sorted by book numbers and arranged behind projecting date guides in the issue trays. In others this is postponed till the book numbers have been carried on to the book-cards. Whatever method of registration is adopted the ultimate result is that a complete charge is got by mechanical means, which obviates the need for writing at the moment of issue. The plan of keeping the book-cards in pockets inside the books has been adopted in some libraries, but of course this destroys the value of the system as an indicator to the staff of books in and out. At the same time, in open-access libraries particularly, it facilitates service at the moment of issue. The conjoined cards of this loose pocket system appear as in the sub-joined diagram :—

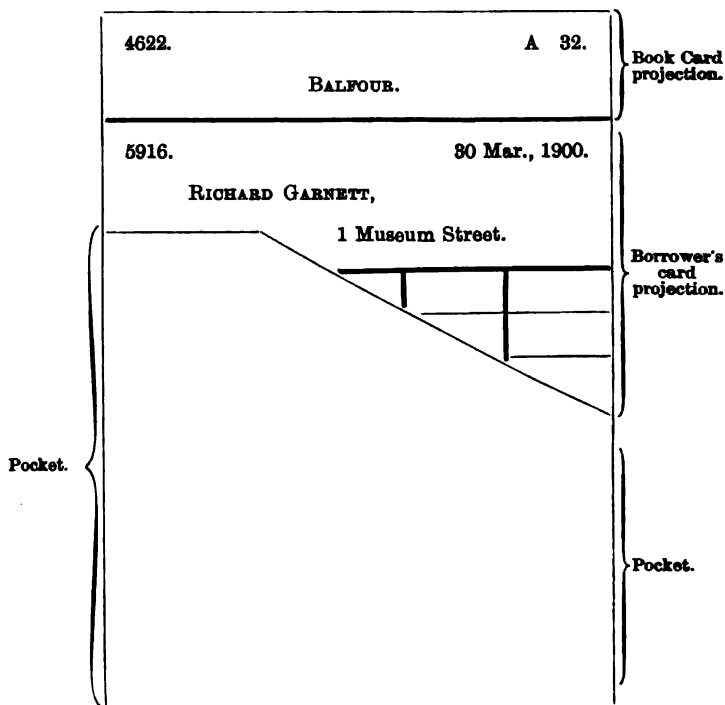

FIG. 161.—Combined Book and Borrower's Cards in Pocket (Section 445).

446. Counter Routine.—In all systems of library charging there are many minor points continually arising which require to be dealt with. The relationship between borrowers and the staff should be cordial and mutually respectful without undue familiarity. Favouritism should be rigidly suppressed in whatever form it appears, and assistants should be taught to treat all classes of readers alike. The Civil Service, or what is sometimes termed the “post-office” manner, which is a mixture of condescension, incivility and Jack-in-officism, is to be sternly repressed. Assistants should be trained to remember that they are the servants and not the masters of the public, and also to exercise all possible charity and philosophy towards the masterful and disagreeable folks who occasionally disturb the calm atmosphere of all public libraries. There is not the slightest doubt that a few pert and incivil assistants can do more harm to the relations between a library and its patrons by their manners, or the want of them, than even silly rules and regulations.

Carelessness in making entries or charges at the counter is a source of continual trouble all round. In indicator charging a common error is to put borrowers' tickets into the wrong numbers, thus causing delay and confusion by indicating the wrong book out, and providing trouble for the day when the book which *has* been issued comes back. There is no means of checking blunders of this sort in connection with any of the forms of indicator commonly used, and assistants should exercise great care at the time of service. It seems an advantage to work the indicator in connection with demand slips, in place of the *viva voce* method, and postponing the actual registration in the issue till a free time. If the indicator book, borrower's card and demand slip are all put together in one rack, any assistant can afterwards post up the indicator books, and, by comparing the number with the slip, cross-check the record. With card charging the most frequent mistakes are those connected with the misplacement of book-cards. The misplacement of a borrower's card is quite a minor matter, as it can be rapidly traced when a book is returned, because the search is confined

to the cards of a single day's issue ; a diminishing lot, which is soon scanned.

A receipt should be given for every sum received for fines, catalogues, waste-paper, etc. Perforated books of 1d., 2d., 3d., 6d. and other vouchers, consecutively numbered, with a counter-foil also numbered, will be found the most convenient.

447. REFERENCE LIST OF AUTHORITIES:—

- Brown, J. D. Charging systems. *See his* "Library Appliances," p. 20.
Browne, Nina E. Another charging system. *Lib. J.*, 1895, p. 168.
Pennock, B. W. The Browne charging system. *Lib. J.*, 1896, p. 294.
Plummer, M. W. Loan systems. *U. S. Educ. Rept.*, 1892-1893, v. 1, p. 898.

For list of abbreviations see Section 88.

CHAPTER XXX.

BOOK DISTRIBUTION.

448. Branch Libraries.—Every large town extending over a wide area must sooner or later face the question of establishing branch libraries, not only as a convenience to the public, but as a relief to the central library. No rule can be laid down as to the distance which any reader should be from the nearest branch or other library. It is one thing to make a symmetrical plan on paper, showing a central library with a ring of branches situated at regular distances, and so placed as to bring every reader within one, half or quarter of a mile of the nearest library, but it is quite a different matter realising this ideal. Topographical difficulties crop up; the matter of density of population has to be considered; and, to crown all, sites or suitable premises cannot always be obtained at, or near, the places selected as the ideal spots. For these reasons, nothing in the way of regular spacing can be aimed at in the provision of branch libraries.

449. A branch library differs from a delivery station in being a miniature central library, carrying its own stock of books, and having its own reading-room accommodation and magazines. A delivery station need not necessarily have a stock of books, beyond those sent in response to applications, and it would have no reading room whatsoever. Branches and deliveries are often confused, no doubt because both provide for book distribution, but beyond this common feature all resemblance ceases. The question of the amount and kind of accommodation which it is desirable to provide depends entirely upon funds, conditions and requirements. For most situations in which branches are necessary, such as the suburbs of large

towns, the minimum provision should include a lending department, general reading room for newspapers and periodicals, and a small reference department, which need not, however, occupy a separate room. All kinds of extra features can be added to this, if necessary, but these will depend upon funds. Some of the branches at Manchester, Birmingham, Liverpool, Hornsey, Croydon, Edinburgh, Bristol, Leicester, Lambeth and Fulham are models of what such establishments should be.

450. It is impossible to lay down any rules for guidance as regards the financing of branches, beyond the general recommendation to keep a separate account of all moneys expended upon each one. Receipts like fines should also be separately accounted for, and the central library should receive a daily or weekly statement of all cash intromissions, issues, occurrences, etc. Such statements can either be rendered upon specially ruled sheets or post-cards, or kept in books according to some such form as shown opposite. An elaborate system of ruled cards for branch library returns is in force at Croydon Public Libraries. All forms, books, etc., at the branch should correspond with those of the central library, and everything affecting administration stated throughout this book applies, though in a modified degree, to branch work.

451. The staff of a branch library need not necessarily be special to it. Indeed, in fairness to library assistants all round, and for the sake of their proper training, we object entirely to branch library work being regarded as in any respect different from central work, and to the view that there is a particle of difference between central and branch assistants. If there is, then it has arisen through the failure to make interchangeability of staff part of the scheme of administration. Branch library assistants have suffered greatly in the past through being regarded as an inferior grade of officer, and because all the important work has been centralised, thus shutting out the branch men from any possibility of complete training in their profession. The result has been that branch assistants usually remain where they are, without hope or chance of promotion, and it has always been a mystery to us what becomes of the played-out, old

branch librarians! Perhaps they find more congenial, better paid and less unfair spheres of work. Again, the people who use branch libraries do not get the advantage of occasionally profiting by the superior brightness and helpfulness of the central men, and the result is not favourable to the library.

452. We strongly urge that every municipal library should

| LIBERTON PUBLIC LIBRARIES. | | | | | | | | | | | | |
|----------------------------|---|---|---|---|---|---|---|---|---|---|---|--------|
| NORTH BRANCH.—REPORT. | | | | | | | | | | | | |
| Date..... | | | | | | | | | | | | |
| Lending Issues . | A | B | C | D | E | F | G | H | J | K | L | Total. |
| Reference Issues . | | | | | | | | | | | | |
| Receipts from Fines | | | | | | | | | | | | |
| „ „ Catalogues, etc. | | | | | | | | | | | | |
| Books asked for | | | | | | | | | | | | |
| Books wanted from Central | | | | | | | | | | | | |
| Supplies wanted | | | | | | | | | | | | |
| Callers and occurrences | | | | | | | | | | | | |
| Signed | | | | | | | | | | | | |

FIG. 162.—Branch Library Return (Section 450).

be treated as a unit, and not as a formless monster composed of many units. However many branches or departments a public library may have, it is still the municipal library of *one* town, and as such should be treated. The staff should not be considered as so many central and so many branch assistants, but as a group of *library assistants*, all on an equality in their

several grades, and the work of the whole organisation should be arranged in such a way that the central and branch work can be equally divided all round. Changes of this kind are wholesome in every way, and enable a perfect check to be kept upon each branch and each assistant without special effort. All the classification, cataloguing and registration work should be done at the central library, but mere routine work like labelling, cutting-up, etc., can be done at the branches if necessary. The staff selected for doing special work like cataloguing can be occasionally relieved from the high pressure of their duties, and they can be sent now and again to take charge of a branch, where their knowledge will be warmly appreciated by dwellers in the outlying districts. Similarly, the men who have been "fielding" for so long can come in to the central and take a turn at the higher class work, and thus learn something of all sides of their adopted profession.

453. In the selection of books for branches the same principles should be applied as we have previously advocated, namely, the endeavour to get a high average of quality and utility in the literature added, and the determination to discard useless books when the time comes. But an effort should be made to vary the contents of branch libraries so as to obtain as catholic and representative a stock as possible. With Fiction, of course, this is not so easy, especially in the case of popular novels by well-known writers, but in other classes this can be done frequently. For instance, if the north branch has So-and-So's *Chemistry*, there is no reason at all why, all things being equal, the south branch should not have Someotherbody's *Chemistry* and the east branch Someoneelse's. Of course it is assumed that these are all text-books of fairly equal merit. As borrowers' tickets should be interchangeable all over the town and not limited to one particular library, this arrangement of different books on similar subjects widely enlarges the borrower's field of choice. If the central and branch libraries are all interconnected by means of the telephone, as they ought to be, a borrower at the north branch can ascertain if Someotherbody's *Chemistry* is there without going

himself, and can easily arrange by waiting a day or shorter time to have the book delivered at the nearest branch. This is a great convenience in many cases, and places the entire resources of the library at the command of readers, no matter where they may live.

454. **Delivery Stations.**—At the very best a delivery station in a town is but a make-shift substitute for a branch, and, from the borrowers' point of view, does not afford a very satisfactory or expeditious service. If books which are wanted are not *in* at the central library, considerable delay and trouble are caused. Borrowers are compelled to make out long lists of the books they desire to read, and as often as not these are all out at the central store. As delivery stations seldom carry a stock of books from which an alternative choice can be made, borrowers are driven to the task of making out new lists or taking anything the delivery attendant can get by telephone, if there is this kind of communication, which is not generally the case, however, as delivery stations are frequently housed in shops or schools and managed by any untrained person obtainable. Apart from all this, a day must elapse, as a rule, before any book wanted can be obtained, even if it is available, and for these reasons we do not advise the establishment of book-delivery stations save in remote and inaccessible parts of a large town, when every other method of giving a local service has been found impracticable.

455. **Travelling Libraries.**—Of much greater importance are travelling libraries, which can be made to serve every purpose of delivery stations, with the great additional advantage of furnishing, in part, the same alternative selection of books as a branch library affords. These libraries are much used in the United States, and take the form of boxes of books numbering from fifty upwards, which can be deposited at fixed points in towns and rural districts, where borrowers can attend and make a choice of reading matter. Boxes of books by this plan can be sent to the care of responsible persons in all parts of a town, and these persons can undertake the local delivery and collection of the books, either for a small fee or as voluntary sub-librarians.

Various kinds of records are necessary to keep track of the boxes and their contents and where and to whom they travel. Very little of this kind of work has been done either in the United Kingdom or America, although the Americans are gradually developing systems of rural travelling libraries and town "home" libraries. The travelling libraries of the States of New York and Wisconsin form a most interesting study, as also do the "home" libraries of the city of Boston. Matters are not ripe in Britain for a rapid development of this kind of work, although proposals for sending complete travelling libraries on a large scale throughout counties have been made by the author, and on a modified scale by other librarians. When the British Parliament think fit to extend the Public Libraries Acts to County Councils and remove the rate limitation, which is simply crippling development in every direction, the municipal and county library authorities will not only be able to deal adequately with outlying districts, but will be in a position to make door-to-door deliveries of books in towns by means of actual travelling libraries on wheels. In this way the people who are not at present touched by the public libraries will be brought into the fold. The day is no doubt at hand when the traditional idea of the function of a public library as a store from which literature is doled out to the people, *if they know what they want*, will be superseded by a very pronounced missionary spirit, and an endeavour to make known in every possible way the value of all kinds of books to all kinds of people. See Section 7.

456. Subscription Departments or Book Clubs.—In some of the older municipal libraries subscription departments or book clubs have been established, as a means of increasing the stock of a library, without much expense. Such departments exist at Bolton, Dewsbury, Dundee, Elgin, Leek, Tyne-mouth, Wednesbury and Workington. They are operated as follows: For a certain annual subscription any library reader or townsman may join this select library. From the subscriptions so received, supplemented in some places we believe by occasional grants from the rate, new books are bought, generally in

accordance with the wishes of a majority of members, but on this point practice varies. For one year these books are at the service of subscribers only, who borrow them in the usual way, for a fortnight or other periods according to circumstances. At the end of the year each book is transferred to the public library, and becomes the property of the library authority for the use of all borrowers. Where the selection is made with discretion, this may seem an economical way of obtaining books for a public library, but there are several very serious objections. As thoroughly democratic institutions public libraries have no right to set up a privileged class in this way, especially as it must be quite evident that the subscriptions cannot pay all the cost of service, lighting, housing, etc. Thus a proportion of the cost of maintenance falls partly on the library funds, and it is doubtful if in the end there is much gain in receiving as a *quid pro quo* a heap of stale and, perhaps, not very judiciously selected books. Another objection is that public libraries have no right to compete with private and commercial subscription libraries, by invading their ground in this somewhat undignified way, for the sake of ministering to the few people who can afford the luxury of a select public library to themselves.

457. Another form of subscription is occasionally indulged in by public libraries. By paying a certain subscription to large commercial libraries, like Mudie's, they are entitled to borrow so many volumes at a time, and these are reissued to the borrowers in the ordinary way, the library being responsible for losses. In small libraries this is often an economical way of obtaining the temporary loan of copies of books which are much boomed, and in this way the people have immediate access to books which might otherwise never be bought, or only obtained in second-hand form long after their interest had faded. The only trouble about this arrangement is that it depends upon the mood of firms, like Mudie's, for its continuance. To what extent these large commercial libraries would endure a constant drain from a hundred or so municipal libraries remains to be seen, as also does the problem of how they would meet the demand when it attained large dimensions. At one time certain of the London

commercial libraries absolutely refused to lend books to public libraries on any terms. Now they are more complaisant.

458. Inter-Library Exchanges.—This is a method of book distribution which has not been tried to any extent among British municipal libraries, and some organisation would be required to place it on a working basis. Briefly, the idea is to enable a public library which has not got a particular book to borrow it from some library which has, assuming all the responsibility for its safety and due return, and making its own arrangement with its borrower for the cost of carriage. This kind of exchanging could be managed better in London than anywhere else, but it could be applied to any group of libraries, such as those of Lancashire, Wales, Yorkshire, Staffordshire, etc. Each exchanging library would require to possess a complete set of class lists and bulletins, or other catalogues, of all the other libraries, and when a demand was made for a book which was not in its possession the assistant could look through the catalogues of the other libraries till he found a copy, and it could then be written for, the borrower paying all resulting expenses. Of course, this arrangement would only apply to non-fictional works. We have done this on several occasions, often with excellent results, and certainly to the amazement and joy of our borrowers, whose admiration for our resources and command of literature in other libraries has made them devoted life supporters of the library! There would be an undoubted advantage, too, if such a privilege could be obtained for public library borrowers from some of the older proprietary libraries with huge stocks of practically unused books which municipal libraries would not buy in the ordinary course. Arrangements whereby books from special scientific or other libraries could be borrowed for the use of local borrowers would also be an arrangement, could it be managed, which would benefit a greater number of students and other persons than at present. But, of course, there would be very serious difficulties in the way of inducing the owners of valuable special libraries to lend books for the use of strangers introduced by municipal library authorities. Meanwhile, because of these difficulties

thousands upon thousands of valuable and useful books are lying idle and neglected in every part of the country; a waste of power which it is sad to contemplate.

459. Statistics.—This seems an appropriate place at which to notice the whole question of the compilation and recording of library statistics. It will be better to discuss the whole subject at one place than to deal with each variety under different headings. For purposes of comparison, the published statistics of British municipal libraries are of very little value, owing to the differences which exist in the methods of compilation. In lending libraries, for example, some places allow fourteen days for reading books, and only fine overdue 1d. a week. Others allow only seven days, and charge 1d. a day for overdue. This makes a difference of very considerable moment. Some libraries count every separate part of a magazine or periodical which is issued, and also every item in a volume of pamphlets, though only one is asked for. Many libraries which are closed for half a day weekly adopt the extraordinary practice of counting such days only as half-days, with the result that they reduce the total number of days open in a year by twenty-six, and thereby add considerably to their daily averages. Thus, if two libraries issue 100,000 volumes each per annum, and one closes for a half-day weekly and the other does not, we get the result that the former, which counts itself as open on 274 days only, has a daily average of 361, while the other, open for 300 days, has a daily average of only 333. If this method of calculation means anything at all, it means that the libraries which close for half a day weekly reckon that they drop about 150 issues every closed afternoon, and thus practically acknowledge that they deprive their borrowers of a considerable number of opportunities for changing their books. (See Section 415.) The number of borrowers shown in some libraries is out of all proportion to the population. A district with 20,000 inhabitants returns its total number of borrowers as 12,000, instead of clearly showing that there are only 1,500 active borrowers on the register. This arises from the practice of numbering borrowers continuously and counting off the lapsed tickets

occasionally. The exact number of borrowers using a library within the year of report, or at the date of report, is the only circumstance of any interest worth recording. To note, year after year, the total registration of borrowers, in such a way as to convey to the careless or ignorant reader the impression that more than half the population are users of the libraries may be very ingenious, but it is very misleading.

460. The classification of most public libraries varies so much that nothing of a definite character can be extracted from it. Certainly comparisons can never be fairly made while one librarian classes his periodicals as science, useful arts, etc., and another lumps his together as miscellaneous. Then some librarians carefully separate Juvenile from Fiction issues, with the idea of reducing their Fiction percentages. Indeed, the anomalies and divergences are so great in every department of library statistics that it is impossible to reduce them to anything like a common basis. Luckily the day seems to have passed when librarians issued comparative tables of issues, etc., with the design of showing how much more work a certain library did in a year than any of the libraries with which it was compared. It may be safely assumed that where very elaborate statistical tables are published, giving in minute detail every little point connected with a library and its branches, the work of such a library is probably of a kind which will not bear very close scrutiny. The fact of the matter is, nobody save the librarian-compiler himself cares a snuff about detailed statistics of this kind. All that the general public or committees require is the total operations in every department, and the state of the stock, etc. (*See* Section 66.)

461. The statistics most in use are those which show monthly and yearly the operations of a library with regard to stock and issues. Monthly and sometimes weekly returns are sent to the local newspapers in many places as a means of stimulating interest in the library, and quarterly, monthly or fortnightly statistics are generally prepared for the information of committees. The statistics prepared for publication in annual reports are generally far too elaborate. Tables showing the month by month and class by class issues and attendances of

some petty branch library or delivery station are absolutely valueless to any one. Matter of this sort can be ascertained from the records without trouble if wanted for any particular purpose, but it is a waste of time and money to print information of this kind. Some library reports are nothing but a series of statistical tables which are left to explain themselves, with the result that nobody takes the trouble to look at them. The information which we suggest in Section 66 should be published will be found to meet every requirement. Points of interest in statistics should be brought out and explained in the narrative reports of committees or librarians.

462. Most of the methods of compiling statistics are incidentally noticed in Sections 201-214, 431-445. Here may be noted a method of permanently recording statistics of library work of all kinds. An issue record book should be kept in every public library, and in this should be entered each day's issues in both lending and reference departments. Separate books of record should be kept for juvenile rooms, branches, attendances in newsrooms, etc., but these need not be very elaborate, and if designed for issues may be modelled on the ruling given below for the Issue Record book :—

| Month : September, 1900. Public Library. Lending Department Issues. | | | | | | | | | | | | | | | |
|---|---|---|---|---|---|---|---|---|---|---|---|--------|----------------|----------------------|----------|
| Date. | A | B | C | D | E | F | G | H | J | K | L | Total. | Daily Average. | Total since Opening. | Remarks. |
| 1 | | | | | | | | | | | | | | | |
| 2 | | | | | | | | | | | | | | | |
| 3 | | | | | | | | | | | | | | | |
| 4 | | | | | | | | | | | | | | | |
| 5 | | | | | | | | | | | | | | | |

FIG. 168.—Issue Record Book—Left-hand Ruling (Section 462).

| Month. | | Reference Department Issues. | | | | | | | | | | | | Total. | Daily Average. | Total since Opening. | Remarks. |
|--------|---|------------------------------|---|---|---|---|---|---|---|---|---|--|--|--------|----------------|----------------------|----------|
| Date. | A | B | C | D | E | F | G | H | J | K | L | | | | | | |
| 1 | | | | | | | | | | | | | | | | | |
| 2 | | | | | | | | | | | | | | | | | |
| 3 | | | | | | | | | | | | | | | | | |
| 4 | | | | | | | | | | | | | | | | | |
| 5 | | | | | | | | | | | | | | | | | |

FIG. 164.—Issue Record Book—Right-hand Ruling (Section 462).

This record book should have about thirty-five lines to the page, exclusive of the headings, to allow one line for each day and leave room for footing up the class columns, etc. The dates, 1 to 31, may be printed down each column, but this will mean leaving gaps for Sundays. It is better to write the dates in for each month, omitting Sundays, which should be entered on a separate page or pages. The issues of each year should be kept together in a series, and, if necessary, the same book can be made to record the issue of branches, juvenile departments, Sundays, by reserving the requisite number of leaves and writing the name of the department at the top of the page. In addition, a page or more, as required, should be reserved for the necessary summaries, which can be entered up to show the total issues month by month in cumulative form. If this is done regularly the figures for the annual or other reports are quite easily obtained. The stock book if kept entered, added and classified up to date will give similar information about books, and so complete information about the work of a library can be obtained from these two records with very little trouble.

463. REFERENCE LIST OF AUTHORITIES :—

- Bostwick, A. E. Branch libraries. Lib. J., 1898, p. 14.
 Branch library work. Lib. J., 1898, Conf. no., pp. 98, 101.
 Branches and Deliveries. Discussion. Lib. J., 1898, Conf. no., p. 26.
 Cole, G. W. Branches and deliveries. U. S. Educ. Rept., 1892-1893, v. 1, p. 709.
 Cole, G. W. Delivery stations or branch libraries. Lib. J., 1892, p. 480.
 Wilson, R. E. Functions of a branch library. P. L., 1901, p. 275.
 Green, E. Branch libraries and delivery stations. L. W., 1901, p. 88.
 Brown, J. D. Village library problem. L., v. 6, p. 99.
 Hutchins, F. A. Local supervision of travelling libraries. Lib. J., 1897, Conf. no., p. 17.
 Hutchins, F. A. Travelling libraries in farming communities (Wisconsin, U. S.). Lib. J., 1896, p. 171.
 Thomson, John. Travelling libraries. Lib. J., 1896, Conf. no., p. 29.
 Travelling libraries in New York (Rules). Lib. J., 1892, p. 487.
 Travelling libraries. Symposium by American librarians. P. L., 1897, pp. 47-51, 54-55.
 Cutler, M. S. Home libraries. Lib. J., 1896, p. 60.
 Home libraries. By C. W. Birtwell and M. S. Cutler. Lib. J., 1894, Conf. no., pp. 9, 13. (Circulating books in small lots in the homes of the working classes.)
 Bostwick, A. E. The tyranny and deceitfulness of statistics. P. L., 1900, p. 190.
 Minto, J. Public library statistics. L., N. S., v. 2, p. 164.
 Briscoe, J. P. Subscription libraries in connection with free public libraries. Transactions of L. A. U. K., Oxford, 1878, p. 19.
 Waite, J. K. Subscription library in connection with a public library. L., v. 5, p. 40.

For list of abbreviations see Section 88.

CHAPTER XXXI.

REFERENCE LIBRARIES.

464. General.—The chief need in a majority of British municipal reference libraries is development along certain lines which will increase their usefulness and popularity. These lines have already been indicated in an article on the subject by the writer, which appeared in the *Library World* for February, 1901, and a few extracts from this will summarise most of the important points in connection with which development should be attempted. "At various times in the history of public libraries writers have advanced the proposition that many rate-supported libraries fail in their object of continuing the education supplied by the public schools, because they do not make sufficient provision for students and serious inquirers. It has been held that newsrooms and lending libraries have been fostered and developed out of all proportion to their value, while reference libraries have been starved or neglected. I understand that this criticism does not apply to the great reference collections at Manchester, Birmingham, Liverpool, etc., but to the smaller municipal libraries of the country, which do not, in many cases, possess proper reference departments at all, but simply have an extension of the lending library in which to store sets of old magazines, or large books which would be awkward to carry about. It is not the object of this article to prove that there are many or few inefficient reference libraries of this description, but simply to put on record some reflections on the general subject.

465. "Whether or not the average British reference library gets fair play by having a reasonable amount appropriated for its maintenance, it has always seemed to me that there is a

strong tendency to use the department as a kind of dumping ground for books which are too old, too large, too expensive, or too useless for the more up-to-date lending library. The result is that, in a great number of cases, British reference libraries are little, incomplete museums of comparatively useless literature, which have been formed without plan or forethought; in some cases because committees have thought fit to accept everything which comes under the heading of 'Donations'. These libraries are not literary workshops as they ought to be, but feeble imitations, on a Lilliputian scale, of the British Museum, in which the tradition is faithfully maintained of collecting everything that comes along, in the hope that it may be valuable and on the off-chance that it may one day be consulted. Small municipal libraries all over the country are diligently cultivating this traditionary policy, forgetful of the fact that the British Museum and similar great institutions throughout the kingdom are doing this class of work most efficiently, because it is their principal business to do so. Why, then, should the smaller libraries continue the hopeless task of trying to rival the great State libraries, which are the proper collectors of the nation's literary produce, by purchasing or accepting useless sets of books which lumber up the shelves and, because of their cost and bulk, simply serve to keep modern up-to-date works out of the library?

466. "It may be admitted that the average British reference library designed for popular use is not to be compared to the average library on similar lines in the United States either as regards equipment or facilities for study. To begin with, the selection of books in the smaller English libraries is unsystematically conducted and the stock is not collected on any definite plan of gradually building up strong sections in every department of knowledge, but mainly on the principle of adding books at haphazard, just as they strike the fancy of the librarian or some member of his committee. In this way a very heterogeneous collection is formed, which generally looks more imposing in bulk than it is in value or utility. The importance of the reference library has not been fully realised in a very

large number of British public libraries, and hence we have many collections of books which are mostly useless, because, as a rule, they form mere fragments of the literature of some department of knowledge. One reason for this seeming neglect of the reference library is to be found in the fact that in a large majority of cases English library authorities do not take the requisite trouble to educate their readers in the uses of a good reference department. At least 75 per cent. of our public libraries require readers to fill up application forms for even the most ordinary works of reference, such as dictionaries, encyclopædias, directories, etc., and in many cases this means a preliminary search in catalogues, by no means perfect, and a further loss of time in writing out such particulars as to the age and occupation of the applicant, together with the author, title, pressmarks, etc., of the book, with the date, and a name and address.

467. "In the United States a great deal of this unnecessary formality has been discarded in favour of the more rational system of admitting readers to select collections of the best and most necessary reference books, well classified to make selection easy and arranged in such a way as to enable the reader to consult and compare a number of books on his subject before making a choice. This is, of course, the old-established practice of libraries like the British Museum, which has been imitated in a variety of ways in a number of British public libraries, such as Cambridge, Aberdeen, Birmingham, Southport, Croydon, Darwen, Manchester and elsewhere, but it is very far from being so general in British rate-supported libraries as it is in the corresponding American municipal libraries. Undoubtedly, this combination of application form and imperfect catalogue is the main reason for the comparative neglect of the average British reference library, coupled with the fact that the selection of books to represent subjects is not all it might be. No busy man can afford the time to use reference libraries for business or other purposes to the extent he would because of these mechanical hindrances. The contrast between the two systems of open shelves and application forms cannot be more strongly

illustrated than by the case of the man who uses the British Museum. If he wants to look up, say, a biographical fact, he simply walks into the reading room, makes for the shelves where the biographical works are shelved, looks up his subject, and in fifteen or ten minutes is out again in the open air, efficiently and well served, without disturbing any one or troubling a single official. In an ordinary open-access municipal library he can do this without first having to procure an admission ticket. On the other hand, he may be driven to consult some work which is not shelved in the reading room of the Museum, and there are plenty of important books not to be found there. He must first spend a considerable amount of time in the catalogue enclosure till he finds the required entry—and he must know the author's name in such a case. He then fills up an application form, and deposits it in a basket at the service desk, having previously secured a numbered seat and written its number on his application form; and then he sits down and—waits. This waiting period may vary from thirty to seventy-five minutes. Never, under any circumstances, have I been served within a shorter time than half an hour, while frequently a longer period has elapsed, and I doubt if any one else has received prompter attention.

468. "Within due limits open access should form a department of every English municipal library, and no doubt the time is coming when it will be more general than it is at present. This kind of unrestricted access to useful books, especially those on technical subjects and books in dictionary form, is not only of immense service to readers, but it teaches the ordinary business man, the workman and the school-boy how to apply the information stored up in books to the ordinary purposes of life. It enables libraries to become engines of utility in the hands of every one, instead of being mere browsing places for idlers or centres of recreation for pastime readers. When I write of open-shelf reference libraries I do not mean open access to all the books on the shelves of a library, but only to those which are likely to be sought and used by a majority of readers. Rare editions of notable books, bibliographical curiosities and so

forth, which only attract a comparatively small number of students, are *not* the kind of books which should be placed on open shelves. The selection in the British Museum reading room is typical of the kind of open library meant, and undoubtedly this is the only kind of reference library which is the slightest use for general open-access purposes. It appears from Mr. Greenwood's *British Library Year-Book*, 1900-1901, that already forty-one British municipal libraries give facilities to readers in the way of providing open access to select collections of reference books, while twenty-seven others give access to the shelves of their reference libraries generally. This shows that there are at least nearly seventy enlightened library authorities in the 400 which exist in the United Kingdom, and with this encouraging fact the question of open access to reference libraries may be left in the meantime.

469. "Almost as important, if not equally so, as the question of permitting readers to handle books in order to choose those most suitable for their purpose, is the question of cataloguing. Very few municipal reference libraries are efficiently catalogued as a whole. Sometimes the catalogue is a bare author-list printed as a supplement to the lending library catalogue. Frequently it is an imperfect series of printed slips mounted up in guard-books and occasionally overhauled. In several cases there is no catalogue at all, either printed or manuscript. The recent great improvements in card and slip-book catalogues render the provision of complete up-to-date catalogues not only possible but imperative; and here I should like to claim for the ordinary reader a little more consideration. For such a person—and he forms perhaps 90 per cent. of those who use public libraries—author catalogues alone are quite useless, in spite of the recent contentings in the *Times* to the contrary. This kind of reader very seldom wants a book by a certain author, although he very often asks for a work *on* that author. His demands almost invariably take the form of inquiries for something on a specific subject—the Horse, Transvaal, Gold-mining, Election Law, Date of a Battle, Tithes, Life of Baden-Powell, Arms of Norway, Words of a Poem, etc. The question of authorship

never troubles him, and progressive librarians should endeavour to show that it need not, by providing full subject and classified catalogues. For one reader who asks for a book by a given author there are fifty who want information on a given subject, and librarians of all kinds should cater for the majority rather than for the one who practically knows his way about. By providing adequate classified catalogues with all necessary author and subject indexes a librarian meets the requirements of all classes of readers, be they students or general readers. Unfortunately this is not the view held everywhere, and the result is to be seen in lists of books which are mere inventories of stock, not properly compiled catalogues in any sense. A reference library catalogue to be of any use, especially when not worked in conjunction with a system of open access or exact classification, should be fully equipped on every side—author, subject, title and class—and to these may be added annotations of obscure books. The only way in which a small library can economically accomplish this, so as to be always up-to-date, is to compile a manuscript catalogue, in a form which will enable additions to be made at any point and to any extent. A printed catalogue has the enormous disadvantages of being out of date the day after it is printed; very costly to produce; comparatively limited in circulation; and of little value outside its own library, unless it is a list of books possessing some unique bibliographical distinction. For all these reasons the catalogues of public reference libraries should be compiled in the manner most likely to aid a majority of readers, and should be provided in a form which readers could consult with ease, and also be capable of indefinite expansion. Without a good up-to-date catalogue no ordinary library can accomplish much.

470. " There is another point which may be noted, and that is the absolute necessity of having intelligent assistants in public reference libraries to aid and direct readers or inquirers in every possible way. The limitation of the library rate is very often pleaded as an excuse for all kinds of shortcomings, and it will doubtless be urged in connection with failures to provide capable reference library staffs. However that may be, the

fact remains that there are plenty of municipal reference libraries at the present time, whose service is in the hands and at the mercy of the frivolous small boy or helpless girl. This kind of inefficient service naturally leads to misunderstandings and trouble and readers become discontented with the whole public library system and sceptical of the value of reference departments. To prevent this it is manifest that library authorities must employ educated assistants capable of handling the reference library for the public good.

471. "Nothing will improve the average English municipal reference library and make it more widely popular and useful to the public so much as development along lines which will lead to systematic formation on scientific lines; open access to a select portion of the library; adequate subject cataloguing and classification, and efficient staff. Such libraries could be increased in value to an enormous degree by the adoption of these measures, and the result would be that public libraries would no longer be so open to the reproach of being day-shelters for the unemployed and lounges for lady novel-readers. That they are far from being anything of the sort requires no proof from me, but nevertheless plenty of people are in existence who believe that they are such refuges, and do not hesitate to place their opinions on record—very often on such slender evidence as is afforded by some single act of inattention or instance of bad cataloguing in a reference library."

472. Records.—In libraries where application forms are used on which to issue reference books, a policy which is still in vogue in a very large number of British municipal libraries, the statistics of issues are obtained by simply counting each day's slips, and posting the class totals into the issue record book (Section 462). Where application forms are used, it is customary to supply blanks in the style shown on page opposite, on which to enter particulars of the book wanted. In some libraries these slips are placed on the shelves in the place of the books issued, and remain there till the books are replaced. To ascertain that no books are missing a senior assistant examines the shelves every morning, and notes any slips still remaining which repre-

sent books issued on the previous day. To facilitate this operation a differently coloured slip is used on alternate days—white to-day, blue to-morrow—so that on a white day the presence of a blue slip will instantly draw attention to a misplacement or a missing book. In other libraries the slips are filed near the point of issue, and remain there as a check against the shelves and the readers till the books are returned.

| SHUTDOWN PUBLIC LIBRARY. | | |
|---|---------------------------|-----------------------|
| REFERENCE DEPARTMENT. | | |
| No Book must on any account be removed from this room, or transferred to other readers. | | |
| Book No. | Author and Title of Book. | Initial of Assistant. |
| | | |
| Name of Applicant..... | | |
| Address..... | | |
| Date..... | | |

FIG. 165.—Reference Library Application Form (Section 472).

Some libraries return the slips to the borrowers as a receipt, and compile their statistics from the books ; others retain the slips and make up their statistics from them. Some libraries also insert an issue label in the inside front of each book, which is stamped every time the book is issued, and thus a record is made of a book's popularity or otherwise, which should prove very handy when discarding has to be considered.

473. It may be stated quite confidently that application forms are no protection against thefts of books. Readers have simply to give a false name and address, and walk off with any book they please. It is a curious commentary upon the alleged safety of barriers, application forms, and other hindrances to library work, that some of the greatest cases of theft from libraries ever known have been perpetrated in connection with barrier libraries using application forms! In open-access reference libraries it is better to ask readers to return their books to the assistant in charge rather than replace them personally. Apart from the check which this plan affords it enables a record to be kept of each day's issues even in open-access libraries. The consultations can be entered up in a rough-ruled and classified book kept for the purpose, and the assistant can replace the books at once.

474. REFERENCE LIST OF AUTHORITIES:—

- Foster, J. E. An open reference library at Cambridge. *L. C.*, v. 5, p. 71.
Reference work in libraries. Symposium of American librarians. *Lib. J.*, 1891, p. 297.
- Wood, B. Open reference shelves. *L.*, v. 4, p. 105.
- Woodruff, E. B. Reference work. *Lib. J.*, 1897, Conf. no., p. 65.
- Foster, W. E. Assistance to readers. *U. S. Educ. Rept.*, 1892-1893, v. 1, p. 982.
- Foster, W. E. The information desk. (On aiding readers and inquirers.) *Lib. J.*, 1894, p. 368.

For list of abbreviations see Section 88.

CHAPTER XXXII.

READING-ROOM METHODS AND SUBSIDIARY DEPARTMENTS.

475. **Newsrooms.**—The chief difference which exists in the composition of British and American libraries is the frequent absence in the latter of general reading rooms in which the principal newspapers are displayed for public use. The newsroom has never been generally recognised in the United States as a necessary department of a public library, and, save in a few exceptional cases, these rooms are not to be found in the average American public library. The nearest approach to the British newsroom in America is the large magazine reading room, in which all kinds of weekly and monthly periodicals are displayed. This is substantially the same as a newsroom, but without the current numbers of daily newspapers. There are reasons why the Americans do not encourage newsrooms, and one is the enormous number of newspapers which exist in every large town. The display of a representative selection of newspapers and the cost of maintaining the department would occupy a very large space, and the funds would be spent to a considerable extent in providing one of the least healthy forms of literature. But, perhaps, the real reason for the American indifference to the newsroom is the sensational and vulgar tone of a very considerable portion of the newspaper press. Comparatively few American newspapers are quite free from such undesirable and objectionable features as sensational and untrue comments on current events, vulgar personalities, exaggeration and misrepresentation in every form, objectionable and dangerous advertisements of all kinds, and a very low level of literary merit. The best fugitive work of American writers of any importance is to be found in the magazines and literary weeklies, which offer a

very marked contrast in every respect, save as regards savoury advertisements, to the somewhat debased character of the majority of American daily newspapers. These are all strong reasons why newsrooms on the British plan are not quite desirable in American libraries, and they apply to a very considerable extent to the altered conditions of recent British journalism. Time was when the average British newspaper represented a high standard of accuracy, fairness and literary ability, but since the importation of many doubtful American catchpenny methods, the whole character of the press has been slowly degenerating. The London halfpenny journals, with their imitations of "snappy" American dodges for startling public attention into a state of high pressure, are the chief offenders, but their example is being followed all over the country. Indeed, the whole tendency of British journalism is such as to provide a very strong argument in favour of the limitation of the newsroom, if not for its entire abolition.

476. The stock arguments in favour of newsrooms are quite reasonable, and have a strong element of truth in them. They attract a class of reader who would not otherwise come to the library at all, and satisfy the literary aspirations of many rate-payers, who would receive no return for their rates but for these newsrooms. The presence of literary, technical and commercial periodicals in the newsroom is also said to attract a large number of interested readers, and no doubt it does; but would this result not be achieved independently of the newspaper element? Newspaper readers are a class apart from all others. The habitual newspaper reader is a man who rarely reads anything else, and people of his sort do not exist in large numbers in public libraries. He belongs to that large body of men who take papers to read at breakfast, or in the train, or at home after work hours, and for him and his kind there is absolutely no kind of attraction in a public newsroom, often crowded far beyond its capacity. In addition to the comparatively small number of real newspaper readers, and those who come for the weekly periodicals, the newsroom attracts quite a different class of persons in the form of loafers, sporting lads and all kinds

of hopeless individuals, to whom the comparative comfort of the newsroom is a kind of snare and attraction. Mr. George Gissing, in one of his sketches, has drawn a somewhat exaggerated picture of such a newsroom haunter, who suffers from a kind of neurosis which drags him irresistibly to a public newsroom, there to indulge his morbid olfactory sense. These individuals form a considerable proportion of the frequenters of newsrooms in large towns, and if any means could be devised of getting rid of them without inconveniencing the genuine out-of-work in search of a situation, it would go far to solve the newsroom difficulty.

477. Many librarians feel that, in spite of its use as a refuge for illiterates, and for those who are out of employment, or those who, otherwise, may reap no advantage from their payment of the library rate, newsrooms cost rather more than is justified by their actual value. When the annual charges for periodicals, fittings, lighting, heating, oversight and proportion of loan are all added together, it will be found that a newsroom costs a very considerable amount, which could be applied to more permanent advantage in a reference room or lending library. The smaller the library the greater is the proportionate cost, and, though the time is not ripe for any drastic proposal, we think committees should seriously consider the question of strict limitation in public newsrooms, at any rate so far as daily newspapers are concerned.

478. Some time ago an epidemic of *blacking out* the betting news *à la Russe* broke out, as an experimental device to discourage and get quit of the sporting element, which in many Midland towns used to obstruct the greater part of the newsrooms. This is mentioned, not as an example to be followed, but as showing the shifts some library authorities are driven to in order to prevent abuses of newsrooms. As a matter of fact the practice of *blacking out* is not largely carried on, and has been abandoned even at the place of its origin. Another and much more sensible suggestion for coping with the betting fraternity is to cease buying or displaying the evening papers, or procuring them so late as to make them useless for the purposes

of the sporting element, while not in any way penalising the working-man reader who comes after 7 P.M. As a further suggestion for limiting the cost and obstructions of most news-rooms in large towns, we propose (1) that only the morning penny daily papers be bought, for the benefit of the unemployed ; (2) that they be displayed from 7 or 8 A.M. till 1 P.M. ; (3) that the whole of them be removed at 1 o'clock, and their places occupied by maps, charts, pictures of current topics, or other similar broadside matter likely to interest and instruct.

479. In this way a newsroom, arranged as shown on the plan at Section 125, could be greatly improved, and the character of its work changed, without in any way interfering with the use of the illustrated periodicals, technical journals and trade papers displayed on the central tables. By utilising the wall space only for newspapers, good oversight is obtained and a certain amount of limitation is forced upon the authority by mechanical means. In arranging newspapers on the stands, care should be taken to separate the popular journals by a few less popular ones, so as to avoid continuous crowding at one or two points. The people who read newspapers should be distributed round the walls as thinly as possible, and this can only be effected by spreading the papers all round the available area.

480. In selecting newspapers for a newsroom the greatest care should be taken to represent all political parties, and at the same time to avoid the sensational element supplied by the cheap London newspapers. All local papers should be taken, if not for display at least for permanent preservation. The leading London dailies should be taken, and perhaps a representative daily from Scotland and Ireland. Foreign newspapers are stale before they arrive, and need not be taken at all. Their places can be much more effectively occupied by representative German, French or Italian illustrated weeklies. American illustrated weeklies should also be taken in preference to the New York dailies, which are useless and out of date by the time they reach this country. It should also be remembered that the London dailies give an epitome of the world's press opinions on any prominent current topic.

481. Magazine Rooms and Periodicals.—The newsroom should be made the store for all the trade, technical and other weeklies which in any way convey *news* in their own particular fields; while the magazine room should be reserved for the monthly and quarterly magazines, reviews and other miscellanies, which are not so much vehicles for the spread of current news. This is a rough division, but it seems a reasonable one for libraries where some distinction must be made between newsrooms and magazine rooms. In the selection of periodicals and magazines the same care should be taken as with newspapers to take only the best and most representative. Committees should make it an invariable rule never to take any sectarian paper, save as a donation, or in response to a widespread public demand. Church and chapel papers are often forced upon libraries by their respective partisans out of sheer rivalry, and when this sort of thing once begins the library is sure to suffer by having to pay dearly for the gratification of mere sectarian feeling. As a matter of fact, no kind of sectarian or fad journals are ever read, save at first and for a short time, by the people who propose them. It is sheer waste of money to subscribe for the papers of this, that, and the other sect, on the sentimental grounds of fair play all round, and meeting the views of large bodies of ratepayers in the same spirit as the wishes of trades or professions are met by providing technical and other journals. But there is this enormous difference. A technical journal appeals to all sects, while a sectarian journal does not, and, as a matter of fact, is seldom read by its adherents once the honour of the faith is vindicated by having it placed in the public library. For these reasons sectarian periodicals of all kinds should be avoided like poison.

482. The arrangement of periodicals and magazines in their respective rooms calls for some notice. There are several ways in actual use which all prove satisfactory, and which are, nevertheless, very different in application. The most common plan of displaying periodicals is to spread them loose all over the tables in strong covers lettered with the titles, and to try and maintain a rough alphabetical order. Another method is

to place the periodicals in their covers in racks like those described in Section 224, No. 79, or without covers in the racks figured in Section 224, Nos. 80-81. The readers are expected to take what periodical they want from these racks, read it at the tables and return it to its place in the rack. As a matter of fact, they either do not return them accurately or else leave them lying on the tables. But in any case this method is preferable to the plan of spreading them over the tables, as it acts in a measure as an indicator to the periodicals in use. A third method is to keep the whole of the periodicals off the tables or racks, and to issue them from a counter or rack which is superintended by an assistant. This can be done in a number of ways, but preferably by means of an indicator such as is described in Section 215. The last plan is one which has the advantage of providing each periodical with a fixed place where it can always be found, though it entails the provision of a separate chair and table space for every magazine, and so requires a much greater amount of space than any of the other methods.

483. With tables provided with racks in the manners shown in Sections 221-223 the periodicals can be arranged alphabetically or classified by kind, and secured to the rack or table by means of stout cords or chains covered with leather to prevent noise. If double-sided tables are provided, with divisions as shown in Section 223, much of the objections to this kind of arrangement is removed. Double-sided tables, especially if narrow, are not comfortable to sit at, either on account of the knees, breath or manners of your *vis-d-vis*, but when divided by means of a screen, as shown in Section 223, much of this objection is removed. But for the question of providing space for every separate periodical, we are disposed to think, after trial of most of the other methods, that the fixed plan, plus some convenient means of inserting a new periodical at any point, is on the whole the most satisfactory all round. It is a decided advantage for a reader to be able to go straight to the place where the magazine he wants is fixed, and to find it always there when directed to it from any form of indicator or periodicals list. If the less popular or valuable periodicals were placed in

a rack similar to that shown in Section 224, Fig. 81, the space required for displaying the better periodicals and magazines would be considerably restricted in area, while there would be a gain in space as well. The plan of keeping all the periodicals together which deal with the same trade or subject is very advantageous.

484. In any plan of displaying periodicals on tables or racks

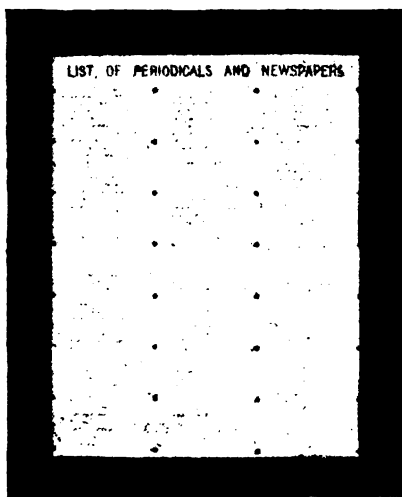

FIG. 166.—Adjustable Periodicals List (Section 483).

a key to the order should be provided in the shape of an adjustable periodical list, which gives a complete list of every periodical or magazine contained in a room. This appliance is thus described, and its appearance shown above:—

“Every librarian must have experienced the nuisance and expense of having to frequently reprint the public list of periodicals supplied to the reading rooms, because of alterations, additions, or discontinuance of magazines. This magazine list-holder is a perfect solution of the difficulty. By its means the name of every periodical taken by the library is clearly dis-

played on a printed movable slip in a glazed English oak frame. This frame has a movable back to which are attached xylonite strips which retain the printed titles of the magazines in place, enabling them to be arranged in any order and to be added to or taken from at pleasure. Thus, the name of a withdrawn or defunct periodical can be easily removed and that of a new one added."

485. The checking of periodicals and newspapers as received, and every morning as they lie on the tables, should be done by means of special records or checks. A very effective form of check card for checking the numbers of magazines or periodicals as received from the newsagent is shown opposite. This shows overdues at once, and enables a complete check to be kept on the delivery of periodicals. One kind of ruling suffices for every kind of periodical, daily, weekly, monthly or quarterly, and the cards are ruled as in the figures on the page opposite with heading and fifty-two lines to the page. If necessary both sides can be ruled, and so one card can be made to last for a long time.

486. In the cards for monthly periodicals the names of the months should be written in advance, the dates of receipt being added against each month as the magazine is received. In the case of weeklies and dailies the numbers are to be entered number by number as received. An overdue can be noticed at once by any one going over the cards, by simply noting that a weekly due on Friday, the day previous to the actual date of publication, has not been entered. These cards should be examined for overdues daily in the case of dailies, and every Friday evening or Saturday morning in the case of weeklies and monthlies. If each kind is stored in a suitable box or portfolio the checking and marking-off can be done with great rapidity. These cards can also be used for annuals, society publications, etc. In the latter case the year can be written at the top of the column, and the publications received for the subscription can be written in the column lengthways. If nothing has been received by the middle of any year, the society can be notified. But the irregularity of society and other subscription publications

| <i>Cornhill Magazine.</i> | | <i>Annual Cost, 9s.</i> | | | | | | | | | |
|--------------------------------|---------|-------------------------|--|-------|--|---------------------------|--|-------|--|-------|--|
| <i>Vendor, Jones & Co.</i> | | <i>Due about 28th.</i> | | | | <i>Location, Rack 80.</i> | | | | | |
| 1901. | | 1902. | | 1903. | | 1904. | | 1905. | | 1906. | |
| No. | Rec. | | | | | | | | | | |
| Jan. | Dec. 28 | | | | | | | | | | |
| Feb. | Jn. 29 | | | | | | | | | | |
| Mar. | Mar. 1 | | | | | | | | | | |
| Apl. | | | | | | | | | | | |
| May | | | | | | | | | | | |

The ruling continues for 52 lines.

FIG. 167.—Periodicals Check Card, Blue (9½" x 6"), Showing Arrangement for Monthlies (Section 485).

| 1901. | | 1902. | | | | | | | | | |
|--------|--------|-------|--|--|--|--|--|--|--|--|--|
| Jun. 1 | Jun. 2 | | | | | | | | | | |
| " 8 | " 9 | | | | | | | | | | |
| " 15 | " 16 | | | | | | | | | | |
| " 22 | " 23 | | | | | | | | | | |
| " 29 | " 30 | | | | | | | | | | |

FIG. 168.—White Card, Showing Arrangement for Weeklies (Section 485).

| < | | 1901. | | | > | < | | 1902. | | | > |
|--------|--|-------|--|--|---|---|--|-------|--|--|---|
| Jun. 1 | | | | | | | | | | | |
| " 3 | | | | | | | | | | | |
| " 4 | | | | | | | | | | | |
| " 5 | | | | | | | | | | | |
| " 6 | | | | | | | | | | | |
| " 7 | | | | | | | | | | | |
| " 8 | | | | | | | | | | | |
| " 10 | | | | | | | | | | | |
| " 11 | | | | | | | | | | | |

FIG. 169.—Buff Card, Showing Arrangement for Dailies (Section 485).

is a feature which requires a good deal of watching, and a card check of some kind is essential.

487. The morning check of periodicals as they lie on the tables should be done by an assistant armed with a list, written or printed on a card, by means of which he or she can follow the order of all the periodicals as they are arranged on stands, tables or racks. Anything missing should be noted on a separate slip of paper, and entered in the work book. The initials of the checker should also be written in the work book in the space provided. (See Section 94.) The librarian should receive the check slip if anything is missing. In similar fashion the assistant who examines the periodical check cards for overdues should notify the librarian of any numbers not promptly received.

488. The filing of magazines should be done as recommended in Section 378. It is not advisable to reserve everything, either for binding or preservation, for a time, and it is wise to make up a list of periodicals and newspapers which it is intended to keep, file them, and give all the remainder away to poorhouses, asylums or similar institutions. Sometimes they can be sold at half-price as withdrawn from the tables, but in most cases all matter of this kind has to be sold as waste-paper.

489. The only satisfactory method of counting the attendances in general reading rooms is by means of a recording turnstile. All other methods of occasional counts and the striking of averages are unreliable. The craze for statistics is so strong, unfortunately, that librarians are driven to satisfy their committees as to the use made of reading rooms, and in the absence of a turnstile the best thing to do is to take whole-day counts as follows: on a Monday in January; Tuesday in February; Wednesday in March, etc.; divide the total by twelve, and multiply the average thus obtained by the number of days open. Every individual who enters or re-enters must be counted. This gives a fair approximation to the actual attendance, and is a better plan and more reasonable than counting the readers present in the rooms every hour or half-hour, adding the totals together, and reckoning the result as the day's attendance.

As an aid in keeping order in public newsrooms it is a good plan to frame a few copies of the 1898 "Act to provide for the Punishment of Offences in Libraries," and to hang them in conspicuous places, along with the admonitory notices regarding "Silence," etc. (Section 419 (37)). The official appearance of a framed Act of Parliament has a daunting effect upon a certain type of mind, and has been found to act as a check upon sporting and loafing individuals.

490. Separate rooms for women are not necessary in most public libraries, and as we have already discussed the matter in Section 154, it need not again be mentioned at length. The sentimental idea that women are delicate creatures requiring seclusion in glass cases is resented no more strongly than by the ladies themselves, and the mere fact that they do use general reading rooms without complaint or hesitation in places where separate accommodation is not provided is quite enough to demonstrate that such rooms are not essential.

491. Juvenile Libraries.—There are decided advantages in providing separate reading rooms and libraries for children, not only to the library and its adult users, but to the children themselves. Many British municipal libraries have provided such accommodation with good results, and it is only want of means which prevents a number of other places from following their example. A juvenile library with no age limit, as recommended in Section 419 (34-36), which has a good selection of books and magazines for reading on the premises, a large and varied stock of the best authors—excluding entirely the goody-goody element—freely accessible, and the whole controlled by a sympathetic yet firm assistant or superintendent, will accomplish wonders in the direction of forming intelligent citizens and furthering the education of children. The special rules for such a library need not be very stringent, and the admission should be made as easy as possible. The guarantee of a parent or school teacher should be accepted without hesitation (Section 419 (35)). If any advanced boys or girls require books which are in the adult libraries, they should be allowed to have them. Power to read and appreciate books should be the sole require-

ment for granting their use. Juvenile rooms should be comfortably furnished and well decorated with prints, maps, etc., but the users should be taught that scrupulous cleanliness is a first condition of admission. It is often difficult to preserve order among the wealth of animal spirits generally assembled in a juvenile reading room, but a little tact and firmness to begin with will produce good results. When a public library has provided an adequate children's room and reduced its age limit to a reasonable and liberal degree, it has done all that is necessary or desirable without trenching upon the work of the public schools or fostering this particular class of youthful citizen at the expense of his seniors who have to find the money.

492. With all respect for the admirable work in connection with children's libraries and the cultivation of intimate relationships with the public schools, both in the United States and Britain, there is a very grave danger of this particular outlet for library enthusiasm becoming a damaging influence on the interests of the general work of public libraries. Already there are libraries in the United States and in England where everything is subordinated to the special cult of the child, and where the claims of adult readers are being brushed aside in the pursuit of what is largely a sentimental phantasy. In America, which is completely ruled by children and servants, as has been truly said by various observers, there may be some excuse for the extraordinary lengths to which this children's library fad has been carried, especially as the means are forthcoming to a greater extent than in Britain; but there is positively no reason at all why English public libraries should add to the difficulties caused by their already straitened means, by undertaking work which every School Authority is perfectly competent and free to do for itself.

493. The provision of juvenile reading rooms and libraries in connection with public library buildings is a legitimate outlet for library funds, but the presentation of collections of books to public schools and the cost of running courses of lectures on abstract subjects for school children are both matters which

should be left severely alone. The School Authorities have plenty of money, in comparison with libraries, with which to equip proper school libraries, and in the case of London and some other towns this has been done in an efficient manner. The School Authorities and other educational bodies have also full power and means of providing everything in the way of oral instruction by lecture or otherwise, and there is a smack of officiousness about any action on the part of library authorities or librarians which tends to interfere with the legitimate work of the schools. Indeed, to many observers, it must appear as if the school educational authorities in America and the United Kingdom had failed lamentably in their duty of providing elementary education, to warrant such interference on the part of librarians. With superior acuteness the American librarians have managed to secure both co-operation and financial assistance from the public school authorities, which is perhaps a sufficient reason for the epidemic at present raging in the United States; but in Britain the libraries are being crippled in their genuine work of catering for all classes, by adventuring upon experiments in connection with school libraries and lectures and a disproportionate expenditure of energy in the cultivation of one department of work.

494. There is something elusive about the eloquent pleas on behalf of children's libraries and work in connection with children and schools which come from the United States. It is difficult to comprehend the real drift of all this effort on behalf of the bairns, because if the schools are turning out young readers, and the libraries have made provision to take them in and carry on their education so far as it can be continued by means of good books and reading, then for what, in the name of common sense, is all this special machinery wanted? We have met the American child—that awful mixture of impudence and precocity—in trains, steamers and hotels, and can only lament if he is the product of the joint efforts of American schools and libraries.

495. The same vagueness exists about the library and schools propaganda in the United Kingdom, though it will often be found that most diligence is exercised on behalf of children

in places where red-tape flourishes, and where special means are taken to exclude boys and girls under fourteen or sixteen years of age from the benefits of the general library. Perhaps, after all, this is the real reason for the excessive zeal in the promotion of *outside* agencies for providing children with books. Children are a nuisance, let us foist them on to the schools till they have grown up and can behave themselves!

496. In our opinion it is much the best course to allow young children to become acquainted with the attractions and uses of good books and the proper function of the public libraries as early as possible, and to this end they should be encouraged to use the municipal libraries, and not be discouraged and put off with petty school libraries or deliveries of small boxes of books sent to schools to be doled out by teachers as a reward for smugness and good behaviour. Let the children come to the libraries like other citizens, and learn to use and appreciate their own public institutions. There is more genuine education to be obtained in this way than in tons of goody-goody lectures on coal, or sugar, or books, delivered by lecturing librarians and teachers. At any rate, it gives children the option of becoming intimately acquainted with public libraries if they wish, and is something more real and tangible than personally conducting them round a library in all the restrictive torture of muzzles and kid gloves. As we have already said, we do not wish to minimise the good work being accomplished in many places by libraries which cater for children in a reasonable and practical manner, but we must enter protest against all attempts to invade the province of the teacher; to spend money in mere outside efforts; and to restrict the general usefulness of libraries in more important directions by a disproportionate cultivation of the "work-for-children" fad. Let the very best possible relationships be cultivated with school teachers, and let librarians enjoy every advantage which mutual co-operation can give, but do not let the question of providing suitable reading for children degenerate into the sentimental old-maidish lines so common in America. There are plenty of philanthropic and educated men who believe that young children would be much more profitably

and healthfully employed playing in the open air than sitting about in stuffy reading rooms, and with this view we cordially agree.

497. **Technical Literature.**—Practice differs very greatly throughout the United Kingdom in the distribution of the money which is received by local authorities under the excise duties. Some libraries receive an annual grant for the purchase of technical books, others receive occasional grants, while the majority of places, including London, receive nothing at all. If one library can legally receive a grant from these moneys, every library should be able to participate. Certainly there seems more advantage to the public in expending this money, or part of it, in the purchase of expensive and valuable technical, art and scientific books, which would be useful to all kinds of people, than playing at giving technical instruction by establishing all kinds of absurd classes for dressmaking, cookery, etc., which are only sparsely attended by a very small number of persons. According to Greenwood's *British Library Year-Book*, 1900, page 268, only thirty-four libraries receive regular or occasional grants from these special technical education funds, and it is therefore time for library authorities to agitate for a more general distribution of these moneys.

498. **Lectures.**—Doubts exist as to whether lectures can be given in connection with public libraries if the cost has to come out of the library rate. If lectures are confined to exposition of the contents of the books in a library, there can be very little objection raised to them on any ground, financial or otherwise; but if they consist of magic-lantern accounts of tours in Palestine, America, China, etc., interspersed with occasional concerts and readings from the poets, we think any district auditor would be justified in surcharging expenditures from the rate for such purposes. It is no part of a public library's work to give courses of general lectures, free or otherwise, and certainly their cost should not come off the book fund of the library, which is, unfortunately, the only available source from which money can be obtained. Lectures are quite a subsidiary part of the work of a municipal library, and should never be undertaken until every

other means of popularising and exploiting the library have failed.

499. EXHIBITIONS of fine art and technical books, or special books of any kind, can be undertaken by municipal libraries if a spare room is available. Such exhibitions have been given at St. Helens, Croydon, Chelsea, Aston Manor, etc., and have been successful in making the people practically acquainted with some of the more rare and expensive books in the libraries. Where open access is allowed such exhibitions are not necessary save for very large expensive and rare works. The ordinary technical and scientific books which form the bulk of such exhibitions would be seen in open-access libraries as a matter of course.

500. It is not proposed to notice museums, art galleries, science schools, or technical schools in this *Manual*. As we have pointed out in Section 5, such departments cannot form a part of any ordinary public library established with a penny rate, and although there are cases of public libraries being united with museums, etc., inquirers must be referred to the special literature of these departments for further information.

501. REFERENCE LIST OF AUTHORITIES :—

PERIODICALS AND NEWSROOMS.

- Baker, E. A. Arrangement of periodicals. L. W., 1899, p. 9.
 Burt, Arnold G. Newsroom arrangement. L. W., 1902, p. 256.
 Dent, R. K. Blacking out of sporting news in free libraries. L., v. 6, p. 127.
 James, H. P. Reading rooms and periodicals. Lib. J., 1896, Conf. no., p. 49.
 Roberts, H. D. Issue of periodicals in the reading room. L., v. 10, p. 33.
 Savage, E. A. A periodicals check. L. W., v. 3, p. 291.
 Supplying of current daily newspapers in free library reading rooms. Symposium by American librarians. Lib. J., 1894, Conf. no., pp. 42, 49, etc.

WOMEN'S ROOMS.

- Wood, B. Women's reading rooms. L., v. 4, p. 108.

JUVENILE LIBRARIES.

- Ballinger, J. Children and public libraries. Greenwood's Year-Book, 1900, p. 46.

- Children, schools and libraries. List of articles on the subject, by M. Dickinson. P. L., 1898, p. 245.
- Dana, J. O. Juvenile and school libraries. *See his "Library Primer,"* pp. 157-167.
- Dousman, M. E. Children's departments. Lib. J., 1896, p. 406.
- Fairchild-Adams. Methods of children's library work. Lib. J., 1897, Conf. no., pp. 19, 28.
- Green, E. Notes on juvenile libraries. L. W., v. 3, p. 129.
- Hewins, C. M. Books that children like. Int. Con., 1897, p. 111.
- Hewins, C. M. Reading of the young. U. S. Educ. Rept., 1892-1893, v. 1, p. 944. (With elaborate tables of American practice.)
- Plummer, M. W. Work for children in free libraries. Lib. J., 1897, p. 679.
- Reading rooms for children. Reports from American libraries. P. L., 1897, p. 125.
- Sanders, M. A. Report on reading for the young. Lib. J., 1890, Conf. no., p. 58.
- Wood, B. Juvenile libraries. L., v. 4, p. 111.

LIBRARIES AND SCHOOLS.

- Adams, H. B. Public libraries and popular education. Albany, University of the State of New York, 1900. (A very valuable report.)
- Axon, W. E. A. Libraries in relation to education. L., v. 5, p. 265.
- Ballinger, J. Public libraries and the schools. L., v. 9, p. 239.
- Ballinger, John. School children in the public libraries. L. A. R., v. 1, p. 64.
- Doren, E. O. School libraries. Lib. J., 1897, p. 190.
- Green, S. S. Libraries and schools. Lib. J., 1891, Conf. no., p. 22.
- James, H. P. Libraries in relation to schools. U. S. Educ. Rept., 1892-1893, v. 1, p. 698.
- Libraries and schools. Juvenile libraries. P. L., School number, 1901, Feb.
- Ogle, J. J. Connection between the public library and the public elementary school. A report based on an inquiry addressed to the free public libraries of England and Wales, and certain American public libraries, 1898. (Contains a select list of papers bearing on the subject.)
- Ogle, J. J. Public library and public elementary schools. L., v. 8, p. 93.
- Schools and libraries, connection between, and methods of working. Lib. J., 1896, April no.
- Winks, W. E. An attempt to solve the school libraries problem. L. A. R. v. 2, p. 190.
- Work between libraries and schools. Symposium by American librarians. Lib. J., 1897, p. 181.
- See also the Library Journal, School numbers, published in April of each year.*

TECHNICAL LIBRARIES.

- Andrews, C. W. Technical collections in public libraries. *Lib. J.*, 1895, p. 6.
- Greenwood, T. Public libraries and technical education. *See his "Public Libraries,"* 1894, p. 479.
- Jast, L. S. Technical libraries. *L. W.*, v. 3, p. 258.
- Lancaster, A. Provision of technical books in public libraries from the technical education fund. *L. A. R.*, v. 2, p. 18.

LECTURES.

- Briscoe, J. P. Half-hour talks about books with library readers. *L.*, v. 7, p. 18.
- Dent, R. K. Free lectures in connection with free public libraries. *L.*, v. 6, p. 354.
- Greenwood, T. Public library lectures. *See his "Public Libraries,"* 1894, p. 470.
- Kimmins, C. W. Lectures under the Public Libraries Acts. *L. A. R.*, v. 3, p. 6.
- Lectures. Symposium by English librarians. *L. W.*, 1899, pp. 121, 162.

EXHIBITIONS.

- Lancaster, A. Exhibitions of books in public libraries. *L.*, v. 6, p. 19.

ART GALLERIES.

- Temple, A. G. Art galleries in relation to public libraries. *L. A. R.*, v. 3, p. 18.
- See publications of Museums Association and Greenwood's "Museum and Art Galleries".*

For list of abbreviations see Section 88.

CHAPTER XXXIII.

PUBLIC ACCESS TO LIBRARY SHELVES.

502. The question of allowing readers to have direct access to the shelves of public libraries has been incidentally touched upon in connection with buildings, classification, charging, reference libraries, etc., and it has been considered in various other aspects all through this book. It now remains to consider the matter as a policy to be adopted in the management of British municipal libraries, and in doing so we shall quote the arguments pro and con, with the reservation that only safeguarded open access is recommended, and not the happy-go-lucky methods which have been found so unsuccessful in various libraries. The most complete and authoritative statement on the question is one based on experience, for which reason it must be regarded as more important than anything else issued by theorists or persons who have never tried any system of open access. This statement is contained in a small illustrated pamphlet, entitled *Account of the Safeguarded Open - Access System in Public Lending Libraries. Prepared and Circulated by the Librarians in charge of English Open - Access Public Libraries.* London, 1899. From this the following extract is made :—

503. " Among the numerous schemes which have been introduced for improving the administration of public libraries and increasing their popularity and usefulness, perhaps none has caused so much discussion and excited so much interest as the system of allowing readers to have direct access to the books as they stand on the shelves of public lending and reference libraries. This has been variously named 'Open access,' 'Free access,' and 'Open shelves,' but in each case the

same thing is meant, namely, the recognition of the public right, under certain necessary regulations or safeguards, to examine and compare books before choosing them for home reading or consultation in a reading room. The idea is not original in its cruder form, as, from the days of the monastic libraries down to the present time, considerations of convenience or the non-existence of catalogues have rendered necessary the practice of allowing readers, in subscription, college, or proprietary libraries, to make their selection after actual examination of the books. In municipal public libraries this course has never, until recently, been adopted to any great extent, chiefly because of the comparatively large number of readers who might avail themselves of the privilege; unsuitable premises; and the tradition, handed down from earlier times, that the general mass of the people are not fit to make intelligent use of their own books, nor to be trusted in any such intimate relationship as open access implies. These considerations and fears for many years proved an effectual barrier between the people and that higher and more rational enjoyment of literature which can only be gained by actual contact with, and personal examination of, books. Every book has an individuality of its own, which can no more be expressed by the transcript of its title-page in a catalogue, than the flavour of wine can be appreciated by merely reading a merchant's price-list. It was to gain all the advantages of examination before selection that an improved method of open access was introduced in English public libraries early in the year 1894, which has demonstrated the value, safety and practicability of the plan in the most complete manner.

504. "The open access which is allowed in colleges, subscription and other libraries differs in many essential points from that which obtains in the safeguarded public libraries, which was first introduced in 1894. The safeguarded method is based upon a full recognition of certain difficulties and dangers which may result from the admission of hundreds of people to the book-shelves of public libraries. Most of the difficulties and dangers will occur at once to any one who gives the matter a thought, and they have been pointed out over and over again by

Sec. 504] PUBLIC ACCESS TO LIBRARY SHELVES.

those who are not in sympathy with the system. First among these is the danger of theft, which on the face of it seems reasonable as an objection and likely enough to happen as a matter of fact. In non-safeguarded open-access libraries thefts are occasionally extensive, though very seldom the work of more than a few persons. It is necessary to make this tribute to the public honesty, as great stress has been laid upon the proneness of weak humanity to steal anything easily come by, but more particularly books and umbrellas. An analysis of some of the most famous cases of theft from college, municipal public and other libraries reveals the fact that out of thousands of readers, the actual delinquents are generally found to be a few stray individuals. Furthermore, a considerable proportion of the so-called thefts from such libraries have resulted from inefficient registration and oversight. When, therefore, a statement is published to the effect that a certain library with 5,000 readers has lost 100 volumes in a given time, it is not to be assumed that these books were stolen by 100 different individuals, but more likely by one or two persons, whose dishonesty is made to recoil on the honest majority, very often to their disadvantage and inconvenience; as, when library authorities discontinue open shelves because a few books have been stolen by one person. These thefts occur in libraries of all kinds, whether open access or not, and do not affect the matter of the public honesty in the slightest degree, but are rather in the same category of morbid phenomena to which psychologists like Lombroso refer all lapses from the normal plane of morality. In safeguarded open-access libraries where care is taken to qualify temptation by means of regulating barriers and careful registration, combined with a fair measure of unobtrusive oversight, such thefts are of the most trifling description. In ten safeguarded open-access libraries where such obvious precautions are taken the average annual losses are only three volumes, value about 6s. or 7s., and in some cases these losses are traceable to other causes than theft. To put it in another way, one book value 2s. 2d. is lost out of every 27,547 volumes circulated, a petty enough tax considering the enormous advan-

tage to the public of direct access to well-arranged and selected libraries.

505. "The second danger, in connection with the admission of hundreds of readers to an orderly array of book-shelves, is the likelihood of extensive misplacement and mixing of books all over the library. In libraries which are arranged in a non-classified numerical or alphabetical order, without any further provision being made to distinguish books from each other, the likelihood of misplacements is not only possible, but certain. On the other hand, in safeguarded open-access libraries, where the books are all closely and exactly classified by subjects, and so marked by means of distinctive labels as to clearly distinguish class from class, subject from subject, and book from book, misplacements are not only comparatively rare, but readily detected and set right when they do occur. Misplacement is only a mechanical difficulty which is easily overcome by simple mechanical means, and the most effective of these has been found to be a series of coloured and specially shaped labels fixed on the backs of the books, which not only show up misplacements instantly, but enable the borrowers or users of the library to keep order themselves almost mechanically. Added to this, the catalogue gives a direct reference to the place of any particular book or topic, so that a reader is not only guided to what he wants, but is enabled to examine everything available on his subject before making his selection, and assisted in correctly replacing any books he may consult. In every safeguarded open-access library where such classification and distinctive markings have been applied, the comparatively few misplacements made by the hundreds of readers who use the library in the course of a day can be rectified by the staff in less than half an hour. Too much is made of the time supposed to be required to rectify misplacements. The shelves of every library *must* be dusted and straitened up daily, whether used by the staff only, or by borrowers as well. During this necessary operation misplacements declare themselves and are corrected, and the few minutes extra time which this duty entails is not worth considering.

Sec. 508] PUBLIC ACCESS TO LIBRARY SHELVES.

506. "The third danger which has been pointed out is that of serious extra wear and tear of the books due to increased handling. Actual experience has proved that this is not to be feared. Seven open-access libraries with an average experience of three years each report that no extra wear and tear has been noticed, while it is somewhat significant that the oldest safeguarded open-access library of all finds its bookbinder's bill the same, while its replacements of worn-out books are just the same as before. Furthermore, it may be observed that in large proprietary libraries giving open access, and in public open-access reference libraries like the British Museum, books are very seldom worn out on account of constant handling. Where books do suffer is in the homes of careless borrowers, and this no system of library administration will overcome, though open access is a step in the direction of teaching people the reverence and care due to good books.

507. "A fourth objection to open access is that twice, or more than twice, the amount of space will be required in which to display the contents of the library. Here again actual experience proves this to be baseless. It has been found to be unnecessary to limit the number of shelves in a tier so much as was expected, and the result is that, when the large public spaces required by other systems are thrown into the library, there is very little difference in the storage capacity between the different kinds of libraries. It is generally admitted that in any kind of library low and easily accessible book-shelves lead to prompt service. When, therefore, a large public library was planned for open access, with all the public lobbies and gangways included, it was found that only a few hundreds of volumes less could be stored than in the same library arranged for another system which did not give open access, but required the provision of a large amount of space for counters and the public.

508. "A fifth objection, or rather misrepresentation, is that cataloguing will be rendered useless, or at any rate be so slight as to make of no avail the elaborate codes of rules compiled for the purposes of promoting good and uniform cataloguing. This

is very misleading, as it is well known among librarians that the first British libraries to introduce explanatory and elaborate catalogues, and annotated guides in magazine form to books added, were safeguarded open-access libraries.

"It is not necessary to dwell upon other objections which have been urged against the system of allowing readers access to their own books, as they are either purely imaginary or trifling. A few remarks on what is claimed for the system and a table showing the results of its actual working in public libraries throughout the country will fitly close this statement; the first to be publicly made by librarians having practical experience of safeguarded open-access libraries.

509. "The main object held in view by the advocates of open access is the extension of the usefulness of public libraries and books by enhancing their educational value in a practical and satisfactory manner. They recognise that nothing is more misleading than the title of the average book, and that, to condemn the public, who are the real owners of municipal libraries, to make choice of books through the medium of catalogues or lists of such titles, is to establish a kind of rate-aided lottery which may serve well enough for the ordinary novel-reader, but is a positive hindrance to the serious student. To secure the end in view, methods of exact classification have been introduced into the safeguarded open-access libraries, by means of which it is possible to display to readers in one place the books possessed by the library on any specific subject. The educational advantage of this is obvious, readers being enabled to choose the book which suits their purpose best by a simple and necessary process of comparison. By rapidly glancing over a dozen books on the history of England a reader can very soon ascertain if the style of the book and its treatment of the subject is suitable to his needs, but more particularly if the period he wishes to study is covered. It is the same with all other subjects, examination and comparison enable an accurate and suitable choice to be made. Instances are on record, by the thousand, of the extraordinary mistakes which have been made by readers through misapprehension of titles appearing

Sec. 509] PUBLIC ACCESS TO LIBRARY SHELVES.

in catalogues. Thus, the Edgeworths' *Essay on Irish Bulls* and Ruskin's *Notes on the Construction of Sheepfolds* have been taken out by farmers and others of an agricultural turn of mind. So also has a modern reprint of Thomas Tusser's *Five Hundred Points of Good Husbandry*, a versified manual of agriculture as it existed in the middle of the sixteenth century, which would never have been called for had the reader seen it beforehand. Another annoying and frequent source of trouble, caused by the ordinary methods of book selection exclusively by catalogue, is that books are continually being taken out which readers have read before, but have been unable to remember or identify by the mere title. All these serious obstacles to intelligent book selection are removed by the open-access system, which also tends to form a much more independent and well-informed type of reader. Access to properly classified libraries is an education in itself, not only improving the public knowledge of literature, but teaching readers the value of books as tools applicable to the everyday usages of life. There is another minor advantage, which is worthy of mention in view of the outcries which have been made against the circulation of dirty books by public libraries. Readers having access to shelves need not select any dirty book, while their aid in overhauling the library tends to keep it not only clean, but up-to-date in every respect. There can be no bookcases filled with useless lumber in libraries freely open to public inspection. Furthermore, borrowers who prefer a large and clear type, or to whom it is a necessity, have an opportunity of selecting books suited to their needs. Not only does open access train readers in the proper use of a library, but in a short time enables them to use the collection exactly as if it were their own. Such access also engenders a sense of proprietorship with its accompanying feeling of public responsibility, and there can be no doubt greater interest in the library and care for its contents are fostered by this system of giving community of rights and privileges. It is an edifying sight to see girls and boys and men and women going straight to the places of their favourite authors or subjects without a moment's hesitation and certainly

with very little of the aimless wandering which has been stated to be inseparable from the system. At one of the larger libraries in the metropolitan district the open-access system was adopted at the central library on the occasion of removing to a new building, which was specially arranged for this purpose. The effect of this was that the borrowers from the two branch libraries, which continued under the old system, began to forsake the branches, and to unduly swell the numbers borrowing from the central. To meet this, in spite of the fact that the branches were housed in two buildings not particularly suitable for the purpose, the necessary alterations were made, and open access adopted all round. The arrangement of most safeguarded open-access libraries provides for Fiction, the most used class, being kept in an alphabetical order of authors' names all round the walls, thus distributing the bulk of the readers over a large area and effectually preventing crowding at any point. The service of readers is also very rapid, as the library assistants, being free from the duty of finding and fetching books, can register them very quickly, and also find time to assist new readers and aid in keeping order and in recommending good books. This they can generally do with good effect, as it frequently happens that the particular book wanted by a reader is in use, and an intelligent librarian or assistant can always recommend a good substitute. This is a very strong point in the open-access system, not only enabling the staff to lend considerable service directly to the borrowers, but affording such readers ample opportunity for helping themselves to something equally suitable, should all the books they have selected from their catalogues be out on loan. It is impossible to satisfy readers in this way by any other system."

This practically sums up the whole matter and presents the view of twelve English librarians who have actually tried and still work the system.

510. The testimony from America is even more favourable, as may be judged from the fact that, at various library conferences where votes have been taken on the question, the results have been progressively favourable. At the Atlanta Conference in

Sec. 512] PUBLIC ACCESS TO LIBRARY SHELVES.

1899 votes were taken on the following questions, with these results :—

“How many favour practically unrestricted access for large libraries for all books ?”—10.

“How many favour practically unrestricted access for smaller libraries ?”—50 (practically unanimous).

“How many are opposed to practically unrestricted access in large libraries ?”—30.

“How many prefer free access to a selected collection of books ?”—48.

511. In the British colonies, especially Australasia and Canada, open access has been recognised for many years, but it does not extend to lending libraries so generally as in England and the United States.

512. On the Continent of Europe, the bureaucratic system of library management which prevails generally is inimical to all ideas of freedom, because in many places it is not so much a question of obtaining access to the shelves, as of being permitted access to the library buildings! Red-tape, jealousy of the public, and safeguarding the officials from troublesome readers are the dominant features of continental library management, though some are entirely free from these faults. At Christiania, in Norway, open access is permitted to parts of the public library. In Denmark conditions are fairly free and progressive. Germany and Russia are cowering under the fear of Socialism, and the bureaucratic ideal of keeping the public at bay has full sway, although there are signs of awakening to better things both in Germany and Austria. In republican France—that hot-bed of Liberty, Equality and Fraternity—the most elaborate precautions are taken to prevent the public from coming into too close contact with their own books. The hours of opening and closing the communal libraries seem specially arranged for the very purpose of giving as few facilities as possible. In other parts of Europe—Holland, Belgium, Switzerland, Italy, Spain—things are no better, and the public libraries may be described as being far behind those of Britain and America, not only as regards open access, but in every other

respect. They are all *museum* libraries on the Continent, with very few exceptions, and their watchword is collect, collect, collect. The idea of making the knowledge stored up in books accessible to the public is one of the last things which the bureaucratic managers of European librarians think fit to concede. But the day for their root-and-branch reform is steadily approaching, and then it will be necessary to choose between red-tape and common sense.

513. Some reflections contributed by the author to the *Library World* in July, 1900, sum up the results to that date as observed in England, and it may be added here that so far as open access to reference library shelves is concerned, the following public libraries grant the privilege more or less generally : Aberdeen, ✓Aberystwith, Acton, Arbroath, Aston Manor, Battersea, Bebington, Bingley, Birmingham, Bridgewater, Brighouse, Buxton, Camberwell, Cambridge, ✓Cardiff, Carlisle, Chiswick, Clapham, Corwen, Croydon, Darwen, Dublin, Edinburgh, Elgin, Finsbury, Folkestone, Gosport, Hampstead, Hawick, Holborn, Jedburgh, Kendal, Kettering, Kidderminster, King's Lynn, Kingston - on - Thames, Lincoln, Manchester, Millom, Northwich, Oldham, Oswestry, Penge, Penrith, Perth, Peterborough, Plymouth, Putney, Queenborough, Reading, Rochester, Rothwell, Runcorn, Selkirk, Southport, Stockton, Stoke Newington, Sunderland, Thornaby, Thurso, Truro, Wandsworth, Warrington, West Bromwich, Westminster, Worcester and Workington. This is a remarkable list considering that, save Cambridge, Birmingham and a few other places, the whole of these places represent recent adoptions of the principle of open access in reference libraries.

Lending library open access on safeguarded lines has been a much slower growth, but considering the comparatively short time which the system has been on trial (safeguarding only dates from 1894) the following list of adoptions is exceedingly encouraging :—

Accrington, Blackpool, Bournemouth, Brighouse, Brighton, Croydon (three libraries), Darwen, Exeter, Finsbury (two libraries), Fulham (one library), Gloucester, Hornsey (three

Sec. 515] PUBLIC ACCESS TO LIBRARY SHELVES.

libraries), Huddersfield, Kettering, Kingston-on-Thames, King's Lynn, Lambeth (one joint library), Northampton, Rothwell, Southport, Widnes and Worcester.

With this digression we subjoin the article previously referred to:—

514. "It is rather remarkable that, whenever the question of open access is mentioned, especially as regards lending libraries, the average English librarian immediately jumps to the conclusion that his method of charging will be affected. Nothing could be more distant from the truth. There is practically no connection between open access as a policy and charging systems of any kind. The direct admission of readers to public library shelves is primarily a question of policy pure and simple, and is independent of any administrative method in particular. While it is the case that most safeguarded open-access libraries have abandoned ledgers and indicators for charging purposes, in favour of cards, there is no reason at all why either of these other methods should not be used if preferred. Open access can be successfully worked with any system of book registration, provided it is effective, and it is, therefore, erroneous to assume that card charging and open shelves are interdependent.

515. "Many librarians object to open access in any shape or form, on the ground that, apart from any technical consideration, they do not believe the public can derive benefit from the direct examination of books. These opinions, which are often quite sincere, are generally based upon a plentiful lack of experience, or upon the reports of librarians whose half-hearted open-access experiments have turned out unfortunate. The authorities of the British Museum would cover themselves with undying ridicule were they to remove all the books from the reading-room shelves because some dishonest reader had stolen a half-crown *Whitaker*. Yet, on very similar pretexts, of an equally slight character, several select reference libraries have been closed, to the great inconvenience of readers. Fortunately for the credit of library authorities in the United Kingdom, the Colonies and America, very little of this kind of feeble administration has been witnessed; and it is an undoubted fact that the

policy of granting free access to select collections of reference books is yearly becoming more widespread and firmly established. Scarcely any objection has been raised to the plan of admitting readers to the shelves of reference libraries, while the outcry against a similar policy for lending libraries has been loud and prolonged. This is somewhat remarkable, when one considers that the value of the average reference book—to put it on this sordid ground—is so much in excess of its humbler lending fellow, while the readers who use such libraries are not, as a rule, selected or guaranteed in any way. It does seem a very anomalous condition of affairs that library authorities should be willing to allow valuable encyclopædias, dictionaries, atlases, magazines, directories and expensive technical works to be freely handled by any passer-by who cares to enter, while all the reputable ratepayers and residents of the town, even after they are carefully sifted out and make declaration of their willingness to guarantee each other, should be denied a similar privilege in the comparatively valueless lending department. I am not prepared to give any reason for this seemingly inverted notion of public library administration, beyond the perfectly obvious one that certain persons who have conceived a prejudice against open access in lending libraries, are not above the common failing, which afflicts most minds so affected, of illogically adopting with enthusiasm the strongest form of the very principle to which they are opposed! It requires no great gift of prophecy to foresee that opposition which blows hot and cold in this erratic way can only have the effect of building up and consolidating the very system it seeks to condemn. Judging by present progress it is perfectly safe to assume that other five years will see every British public library of any importance duly equipped with its open-shelf reference department.

516. "Turning now to the lending department. Here the opposition has been very strong, but not unhealthy. By drawing attention in a widespread fashion to a piece of library policy which otherwise would have languished for lack of proper advertising, open-access opponents have unconsciously rendered an enormous service to the cause. Their cheerful denunciations

Sec. 517] PUBLIC ACCESS TO LIBRARY SHELVES.

have had the direct effect of inducing at least eight library authorities to adopt open access, and their criticisms have contributed something towards the improvement of the methods associated with the system. Many librarians and committee men who have obtained their first intimation of the existence of the system from literature directed against it, have been drawn into an investigation of the other side of the question, and, in most cases, have emerged converts to it. Thus is once more demonstrated the necessity and value of opposition to the proper evolution of reform.

517. "While a great deal has been published about the real or imaginary dangers and disadvantages of open access in lending libraries, very little has been said as to its influence on the development of improved library methods. If it was responsible for nothing more than materially assisting to lift library administration out of the stagnant rut into which it was falling, it would be deserving of not a little credit on that score alone. But it has done considerably more, particularly in the direction of improved methods of classification and cataloguing, to stimulate and change many ideas connected with librarianship which were in danger of becoming fixed. The public, for whose benefit all experiments in library management are undertaken, appreciate variety and forward progress much more than many easy-going librarians and assistants suppose. A library which keeps on running along one set groove, year after year, never attempting change or improvement of any sort, is not the kind of institution to achieve much distinction or success, either locally or otherwise. It is just as likely to become a tolerated failure as any business which goes droning along without any effort to attract attention or extend its usefulness. Unfortunately, it is this public side of the question which may by-and-by make itself felt. Librarians and assistants are never tired of lamenting their hard lot and small salaries, but they rarely attribute the hardships, whatever they may be, to the real cause. The limitation of the library rate is popularly supposed to be at the root of all evil, but more often, in my opinion, it is the failure to make libraries interesting both to public and local

authorities. It is not enough to organise a library on certain recognised mechanical lines and expect it to run on for ever as a flourishing concern. Any one without training can do this if certain methods are followed, but if a library is to prove always attractive and interesting, something beyond the original narrow scheme of foundation is required. Some time ago a well-known American public man expressed the view that the average English librarian was only a kind of superior clerk, without technical training, book knowledge or initiative of any kind, controlled and limited by the sole ambition to make his office as easy a sinecure as possible, and quite blind to the possibilities of developing library administration along certain scientific lines. He supported his opinion by citing the extraordinary indifference of most English librarians to such an elementary and needful thing as classification; pointed out the mediocre condition of certain public libraries he had visited; and mentioned the hostility to open access as a certain proof, either of prejudice or indifference to practical questions. After we deduct a considerable amount of American exaggeration from this, enough remains of truth to give ample ground for reflection. In these days of progress in every direction it will not do for any department of municipal administration to lag behind, particularly one so closely in touch with the people as a public library. Unless efforts at improvement are made by the libraries themselves, it is vain to expect more recognition from the public. Previous to the advent of the safeguarded open-access method in 1892-1893, library work in nearly every department was drifting into a state of stagnation. But when this system was established, with its accompaniments—close classification, annotated cataloguing, class lists, literary bulletins or magazines, and other advanced features—the whole field of library administration was found to be capable of immense improvements in new directions, and the result is to be seen in fresh activity where formerly all was apathy. The feeling in favour of more freedom to readers is growing every year, and it has been steadily growing since 1893, taking the form of age limitations being removed or modified; greater facilities to the public as regards access to

Sec. 518] PUBLIC ACCESS TO LIBRARY SHELVES.

books and the number loaned at one time; and in many other ways which need not be enumerated in a professional journal. So far from being a terrible revolutionary or retrograde movement—it has been called both—lending open access has done nothing worse than direct thought into comparatively unexplored channels, while it has not wrought that moral destruction to the public which has been so often prophesied. Instead, it has proved beyond all doubt that the public is a very fine fellow indeed, who will properly recognise and reward any widespread and liberal effort for his convenience. If, therefore, librarians and their assistants, instead of growling and criticising new departures on theoretical or merely prejudicial grounds, would examine for themselves, and adopt everything within reason designed for the public good, adding or modifying whatever their own ingenuity suggested, the general effect would be an all round improvement in the public libraries of the country, which would very soon secure adequate recognition from both local and imperial authorities.

“This article is not so much a plea for open access in the abstract, as one for a fair examination of the system on the ground that it has already indirectly influenced important branches of library practice, and ought not to be lightly passed over as a mere fad. It has not once been condemned by the public who have used it, and most of the librarians who have publicly made adverse comments were not, because of their lack of experience, the most reliable or best qualified judges.

518. “The practical side of safeguarded open access, which has been unkindly referred to as an elaborate system of bolstering up a crumbling edifice and preventing fraud, is, from a librarian’s standpoint, really one of the most interesting studies possible to imagine. Not only does it comprise all problems connected with classification, cataloguing and charging, but it exhibits them in a new environment, and presents them in quite a fresh aspect. Again, the difficult and important problem of how best to serve the public without too much red-tape solves itself to a very great extent, and even the elements of library

planning may be studied under novel conditions in which lurk all kinds of great possibilities.

“The ground-plan of an open-access lending library is as much an education in book-lore to a mind of ordinary intelligence, as a good map is to a cyclist in topography. Compare the arrangement of a safeguarded open-access library with the happy-go-lucky confusion which reigns in an ordinary restricted library. On the one hand, you have a well-classified and attractive library which will interest any book-lover. On the other, you have a huge undigested mass of books, thrust higgledy-piggledy on the shelves, useless to the reader if he could get at them, and only attractive as a kind of warehouse containing something which a possible reader may want if he only knew where to look for it. The plan of the Croydon Central Library will illustrate better than words, claims or descriptions the enormous difference between a *library* and a place where books are kept in bond !

“These random reflections by no means exhaust the possibilities of the theme, though they do occupy all the space that can be found for them here. They are put forward more as an introduction to the consideration of open access than as a formal exposition of the merits of the system. It is, after all, only one way towards the improved methods of library administration which most librarians seek, and is but a short step on the road to the ideal plan of circulating and communicating knowledge by books. A method which has lived for over six years, throughout good and bad report—mostly bad, unfortunately—which gets more adherents every year, and is steadily improving on its technical side, is not the one to die because of a little opposition, but is more likely to spread with greater strength as time advances. For these reasons, if professional curiosity is not a sufficient incentive, it behoves every librarian to make a serious study of the possibilities of the system ; but in particular to test it fairly before committing himself to opinions, based chiefly on inexperience, which he may afterwards rue.”

519. The arguments against open access come almost entirely from librarians who have never had any practical

Sec. 520] PUBLIC ACCESS TO LIBRARY SHELVES.

experience of the system, in any shape or form, or from librarians who have tried imperfect, non-safeguarded forms. We prefer to pass over in silence the matter which has emanated in immense quantities from representatives of the commercial side of the question. Most of the genuine arguments against public access to shelves had already been duly weighed and provided for by the pioneers of the safeguarded methods, while most of them are also noticed in the arguments in favour of the system, some of which we have already printed. The continental bureaucratic idea of the subject is ably expressed in Graessel's *Manuel de Bibliothéconomie*, as translated into French by M. Jules Laude, and gives what we may call the German-French view of public rights.

520. "If the reading room of a public library is to be open to all, it goes without saying that this is not the same as opening the book-store for the public. How will the librarian proceed in his responsibility for the security, the integrity and, in a word, the good standing of his library, if all the visitors have the right of entry and of walking at their will through the rooms designed for the preservation of books, there to select from the book-shelves such works as they pleased? Would it be well to organise in each room a special service for oversight? But, even admitting that there is a sufficient staff, there will still be the difficulty of preventing losses and thefts, and in all cases the impossibility of preventing the frightful disorders which the public, always more or less careless, will not hesitate to make among the shelves. In the university libraries of Germany the professors alone have free access to the book-stores, but even this system is opposed to good order and otherwise defective. It would be much better, in our opinion, to apply everywhere the rigorous measures taken in this respect by the university libraries of France, and absolutely forbid the entrance to the rooms of all persons save the staff of the library." So much for Teutonic freedom, which exists chiefly in the patriotic *lieder* of the country; and the "Liberté, Egalité, Fraternité" of La Belle France, a motto which exists in profusion on the architectural *façades* of her public buildings, but has a very

poor show indeed in the *salle* set apart for the cultivation of learning!

521. The voice of the conservative American has been raised in the person of Mr. E. S. Willcox, of the Peoria, Ill., Public Library, who gives his views in the *Library Journal* for March, 1900. He bases his remarks on certain losses reported from Minneapolis, Cleveland, Buffalo, Denver and St. Louis, and sums up his argument thus:—

“These then are some of my objections to the open-shelf system:—

“The books are liable to constant disorder;

“They are damaged wantonly by excessive handling and fingering;

“They are mutilated and stolen to a shocking extent, and the theft must necessarily be connived at in order to justify the system.

“How much better is a library served by educated, intelligent assistants, themselves sole and responsible guardians of its accumulated treasures, all growing daily more familiar with the contents of the books, and the older, more experienced ones, when help is needed by the younger ones, able to answer or find an answer to all inquiries—a library well equipped with catalogues and a public instructed how to use them! It is such a library as this that is of the greatest good to the greatest number; it makes itself felt as a great educational force in a city.”

Mr. Willcox is the only out-and-out American denouncer of open access we have been able to discover, though there are others who believe in limitations, and discuss the morality of putting temptations to steal in the way of the people! As if it made a particle of difference, from the ethical point of view, whether a book was “lifted” from an open shelf or stolen after writing out an application form and giving a false address. Mr. Willcox, who has had no experience of safeguarded open access, was answered very effectively by several more liberal American librarians, one of whom sums up the matter

Sec. 523] PUBLIC ACCESS TO LIBRARY SHELVES.

thus: "Very few libraries change from the open to the closed arrangement, while the reverse has become quite a common practice".

522. That the Americans did not contemplate open access in 1876, when the large report on public libraries in the United States was published, is evident from the following extract from W. F. Poole's *How to make Town Libraries Successful*, the only reference to the subject we have been able to find: "It will be found a great convenience to have in the sight of borrowers a shelf of the last twenty or fifty new accessions to the library, and, when it is safe, to permit the borrowers to examine these. In some communities the liberty could not be safely granted, but when it is, the scrutiny will save a great many questions and a good deal of trouble."

523. The opposition literature in England is confined almost entirely to pamphlets and newspaper articles issued by persons commercially interested in indicators, so that it is difficult to supply in a handy form the deliberate opinion of any librarian who has thoroughly studied the question. Unfortunately, too, the question is muddled up with other outside matters, and a failure on the part of most librarians to discriminate between reference access, lending access, safeguarded access and non-safeguarded access. Nearly every writer in opposition to safeguarded open access has dragged in as examples of failure certain experiments on non-safeguarded lines which were conducted in university, subscription and public municipal libraries long before the methods now considered essential to successful management were thought about or devised. As examples of this style of misrepresentation we shall quote one or two typical cases. It was asserted that quite recently the Liverpool Public Library had to abandon open access to the shelves because of the great losses of books. This refers to quite an old experiment conducted in the Picton Reading Room (*Reference*) without safeguards in 1887, and was thus referred to by the librarian in a paper entitled "Experientia Docet," read before the Library Association in 1888: "Still I do not think that the depredations (principally of one

man) would have caused me to recommend the committee to close these alcoves could I have seen my way clearly towards securing them wholly for the use of *bond-fide* students, to whom quietness and seclusion are very desirable, and in some cases almost indispensable". This is a very different account of the affair from the highly coloured versions which were spread about to the effect that Liverpool had tried open access (safeguarded lending implied) with disastrous results. In this connection it is interesting to note that Liverpool has reintroduced reference open access with conspicuous success. The case of Blackburn is precisely the same. The late librarian allowed a few special readers to go to the unclassified shelves of the lending department, where there were no safeguards whatever and only a numerical arrangement, and this privilege was afterwards cancelled because misplacements were so frequent. *This* was published as a failure of safeguarded open access, although it took place nearly ten years before safeguarded systems were dreamt about. All the other cases are variations of these, and need not be noticed further.

524. The best and fairest English statement against open access we have been able to find is that contributed by Mr. W. E. Doubleday, Librarian of the Borough of Hampstead, to the *Library*, New Series (v. i., p. 187). It is entitled "The Open-Access Question," and replies to a previous article by Mr. H. K. Moore. It is somewhat unfortunate that Mr. Doubleday should labour under the disadvantage of having had no experience of open access, which rather stultifies his remarks on comparative cost, and that he should have accepted without full inquiry the claims that certain libraries which abandoned open access were worked on safeguarded principles. Apart from this, his arguments are fair and very well-put theoretical objections to the system. The following extracts give the gist of his remarks :—

525. "At first blush a scheme that provides for the direct admission of the public to the books upon the shelves may seem so obviously the best as to admit of no discussion. But there are others who doubt the solidity of its advantages; and its

Sec. 525] PUBLIC ACCESS TO LIBRARY SHELVES.

superiority at once becomes a mere matter of opinion. . . . I am of those who, whilst fully conscious of the academic beauty of the scheme, have yet to be convinced that it fulfils the somewhat extensive claims made on its behalf. . . . Let it be admitted that safeguarded open access is no Quixotic fancy. Accept it as a practical system of library work which has been subjected to an experimental stage of no ordinary rigour. If it has given so large a measure of satisfaction at Clerkenwell and Croydon it must have much that is good about it. If not, it would have gone to the wall ere now. On the other hand, the fact that in other places it has provoked such bitter disapproval is proof presumptive that there is something to be said against it. It cannot but be satisfactory to all unbiassed minds to find that the plan *can* be worked with so much success; yet others have found that it leads: (a) to crushing; (b) to disorder amongst the books, and sometimes amongst the borrowers; (c) to excessive wear and tear of books; (d) to loss of space; and (e) to theft. These are the doubts which determine so many library authorities not to commit themselves to the plan when a new library is about to be established. These are positive fears which, coupled with the opinion that it is no better—if no worse—than rival systems, cause so many librarians to view it askance. It has not yet been demonstrated that open access⁸ is the superior convenience that some people would have us believe. That issues go up, and especially where a new central library supplants a more or less inefficient makeshift, is only to be expected. People will always like the larger and newer selection from which to choose. But that all borrowers do not prefer the open-access system is a fact. . . . Of such minor matters as misplacement, damage to fixtures, etc., we need not stay to speak. It were idle to quibble about details which barely touch the merits of the scheme. . . . Too much is probably made of the educational value of permitting the public to rummage the shelves. A considerable proportion of our borrowers are accustomed to obtain their books by messengers. It cannot be denied that many of these are of a calibre to which free access and close classification are a stupefying

mystery. For students the idea is admirable; but these are all too few.

“ Surveying the varying aspects of the question, and rigidly excluding all extraneous considerations, it is clear that unless open access is thoroughly safeguarded it must infallibly lead to anarchy and waste. Nothing could be worse. With sufficient safeguards, which ought not to be obtrusive or otherwise vexatious, and in a building adapted to its peculiar necessities, the plan in many respects is excellent. I am not anxious to condemn it. It *may* be that it is better than the various indicator systems; but, if so, it is strange that so few library authorities—all seeking the public good—have been sufficiently convinced of its superiority to adopt the scheme. I will not dogmatically assert that it is absolutely inferior to the indicator plan. In both the trouble of selecting the book falls upon the borrower. In one the reader goes to the shelf; in the other he goes to the indicator. The opportunities for giving information are the same in either case. But open access entails risks, and in all probability recurrent expenses, which other systems do not. If public convenience counterbalances these faults, well and good. But it has yet to be shown that borrowers are, as a matter of fact, and apart from all sentiment, better served by going to the shelves than by using a library that is fully and intelligently catalogued. The general sense of librarians agrees that a good general catalogue is preferable to the class-lists which apparently are thought sufficient for open-access libraries. And this view must be strengthened if the catalogues pay due attention to subject-headings and are annotated. This point is strictly cognate to the argument; for the counter-contention to the new scheme is that a properly conducted lending library, using an approved method for the issue of books, and with a judiciously annotated catalogue, gives at least equal satisfaction to its patrons, is safer, cleaner, and less costly than safeguarded open access.”

526. The main conclusion to be derived from a study of the literature and progress of safeguarded open access to lending and reference libraries is that librarians can no longer afford

Sec. 527] PUBLIC ACCESS TO LIBRARY SHELVES.

to ignore it on the ground that it is a mere fad, which must for ever be regarded as in an experimental stage. Ten years' actual trial is quite long enough for an experimental stage, and the time has arrived when due consideration must be given to the policy of open access, in common with every other method of modern public library management. Open access has come to stay, and both committees and librarians are in duty bound to seriously consider its claims when making their plans for the establishment of new libraries.

527. REFERENCE LIST OF AUTHORITIES:—

CHRONOLOGICAL LIST OF EARLIEST LITERATURE.

Edwards, Edward. Free town libraries, 1869, p. 45. Ref. Access. Brit. Mus. plan.

“Whatever the extent of the book-presses assigned in the reading room for the reception of that series of ‘books of reference’ which is provided for the free use of readers (without the formality of application by tickets), space should be kept in reserve for the future *increase* of the collection, without diminishing the present tenants of the shelves.”

Barry, Sir R. On binding.

— On lending books.

Conference of Librarians, 1877, pp. 119, 184, 194.

Contains notes on marking books to distinguish class from class in shelves, and on the open access to shelves, on the Brit. Mus. plan, granted in Melbourne Pub. Ref. Liby.

Foster, W. E. Classification from the reader's point of view. Lib. J., 1890, pp. 6-9, Conf. no.

Considers open access and advantages of exact classification.

Hosmer, Jas. K. On Browsing. Lib. J., 1890, Conf. no., pp. 88-87.

Plea for reference access.

Brett, W. H. Rearrangement of the Cleveland Public Library. Lib. J., 1890, p. 186.

Open-access to non-fictional literature in alcoves of locked and glazed bookcases, controlled by an assistant.

Access to the shelves. Lib. J., 1890, pp. 197, 229.

Various opinions on reference access.

Higginson, Thos. W. Access to the shelves. Lib. J., 1891, p. 268.

Chiefly reference access.

Putnam, H. Access to the shelves a possible function of branch libraries. Lib. J., 1891, Conf. no., p. 62.

Brown, J. D. "A plea for liberty" to readers to help themselves, *anon.* L., 1892, p. 302.

The first proposal for safeguarded open access to public lending libraries, with a plan. Written in 1891.

Brett, W. H. The open library. Lib. J., 1892, p. 445.

Access to shelves. Discussion. Lib. J., 1893, Conf. no., p. 11.

Brown-Fincham. Clerkenwell Open Lending Library. L., v. 6, p. 344.

Steiner and Ranck. Report on access to the shelves. Lib. J., 1894, Conf. no., p. 87.

LATER LITERATURE.

Account of the safeguarded open-access system in public lending libraries.

By the librarians in charge of English open-access public libraries. Lond., 1899.

Bostwick, A. E. Open shelves and book theft. Lib. J., 1900, p. 280.

Brett, W. H. Freedom in public libraries. Int. Con., 1897, p. 79.

Brown, J. D. Open libraries from a British standpoint. Lib. J., 1895, p. 9.

Discussion of open shelves in the light of actual experience. Lib. J., 1899, Atlanta Conf. no., p. 186.

Doubleday, W. E. The open-access question. (Reply to Moore's article.) L., N. S., v. 1, p. 187.

Green, S. S. Discrimination regarding "open shelves" in libraries. Lib. J., 1899, p. 517.

Lord, I. E. Open shelves and public morals. Lib. J., 1901, p. 65.

Montgomery, T. L. Open shelves. (Reply to Willcox.) Lib. J., 1900, p. 168.

Moore, H. K. Open access in public lending libraries. L., N. S., v. 1, p. 49.

Open shelf. Symposium at Montreal Conference of the A. L. A., by Green, Wright, Foster, Elmendorf and Bostwick. Lib. J., Conf. no., pp. 34-40.

Teggart, F. J. Access to the shelves. Lib. J., 1899, p. 667.

Thomson, John. Report on open shelves. Lib. J., 1898, Conf. no., p. 40.

Willcox, E. S. Open shelves. Lib. J., 1900, p. 113.

For list of abbreviations see Section 88.

END.

INDEX

[The Numbers are those of Sections, not Pages.]

- ABSTRACT** stock sheets, 310.
Access to shelves. *See* Open Access.
Accession methods, 286-304.
Accounts, library, 42-52.
Acland, A. H. D., 87, 283.
Acts of Parliament, general, 1.
 — special, 2.
Adams, C. K., 87, 284.
 — H. B., 130, 501.
Additions, lists of: placard, 364; card, 350; bulletin, 336; press, 341; showcase, 216.
Adjustable classification, 312.
 — book holders, 199.
 — indicator, 213.
 — sheaf catalogue, 363.
 — shelving, 179.
Adoption of Acts, 4 (*a, b*), 16-19.
 — resolution for, 17.
Advertising for officers, 74.
 — for architects, 118.
 — for building contracts, 127.
Age limits, 409.
Agenda for committees, 28.
Agreements, 58.
"A.L.A." catalogue, 87, 283.
Aldred, T., 285.
Allibone, S. A., 87, 283.
America. *See* United States.
American Library Association catalogue, 87, 283.
 — cataloguing rules, 328.
Ames, J., 87.
Anderson, P. J., 319, 325.
Andrews, C. W., 343, 501.
 — E. P., 285.
Annotations, 330 (*i-j*), 330 (4), 331, 333-39.
Anonymous works, 330 (2).
Appraisal of books, 330 (4), 331, 333-39.
Archer, W., 306.
Architectural competitions, 118.
Architecture, library, 110-56.
Art galleries, 5, 150, 500, 501.
Assessment to rates and taxes, 60.
Assistants, examinations, duties, salaries, hours, etc., 90-102.
Attendances at committee meetings, 31.
 — counting, 489.
Audit of accounts, 52.
Austin, W., 379.
Author entries, 390.
Axon, W. E. A., 285, 501.

BAILLIE, G., 20.
Baker, E. A., 284, 285, 331, 501.
Balances of rate, 35.
Ballinger, J., 15, 32, 285, 501.
Banking account, 43.
Bardwell, W. A., 379.
Barnett, S. A., 421.
Barrett, F. T., 285, 331.
 — indicators, 205, 209.
Barriers, 158.
Barry, Sir R., 527.
Benedict, St., Rule, 432.
Bespeaking books, 420 (23).
Best books, 263.
Betting news, "black-out," 478.
Binders for catalogues, 347, 359-64.
 — for papers, 243.
Binding. *See* Bookbinding.
Birge, E. A., 427.
Biscoe, W. S., 379.
Blackburn, C. F., 87.
 — Library open access, 523.
"Black-out" betting news, 478.
Blades, W., 87.
Blank forms, 330.
Blind, books for the, 275.

INDEX.

[The Numbers are those of Sections, not Pages.]

- Bodleian Library cataloguing rules, 328 (8) (8).
 Bolton, C. K., 427.
 — H. C., 87.
 Bonazzi, 311.
 Bond, H., 331 (annotations).
 Bonnange card tray, 355.
 Bookbinding, 336-406; specification, 397.
 Book cards, 296.
 — carriers, 198.
 Bookcases, 175-88.
 Book clubs, 456.
 — discarding, 277.
 Book-keeping, library, 43.
 Book marks, 400.
 — ordering, 292-93.
 — Prices current, 87.
 — rests, 196-98.
 — selection, 251-85.
 — stands, 198.
 Boosé, J. R., 15.
 Borrajo, E. M., 285.
 Borrowers, registration, 422-30.
 Borrowing money for library purposes, 36-41.
 — rights, 411.
 Bostwick, A. E., 463, 527.
 Bowen, H. C., 87.
 Bowker, R. R., 87.
 Boxes for filing, 242.
 Branch libraries, 448-53.
 Brassington, W. S., 87.
 Brett, W. H., 421, 527.
 Brewer, E. C., 87.
 Briscoe, J. P., 463, 501.
 British Museum, 87, 328 (8), 345.
 Brown, J. D., 87, 174, 266, 284, 285, 306, 308, 309, 310, 311, 312, 331, 344, 366, 442, 447, 463, 513, 527.
 Browne, N. E., 421, 443, 447.
 Brunet, J. C., 87, 311.
 Brydon, J. M., 130.
 Budget, annual financial, 53.
 Building specification and contracts, 126.
 Buildings, legislative provision for, 8.
 — theory of library plans, 110-30.
 Bullen, G., 87.
 Bulletins (periodical), 331, 336.
 — (catalogue), 336.
 Burgoyne, F. J., 87, 130, 139, 174, 285.
 Burns, the poet, as a librarian, 431.
 Burt, A. G., 501.
 Burton, J. H., 87.
 Bye-laws, 419-22.
 CABINETS, card, 363-70.
 — filing, 242.
 — stationery, 395.
 Card catalogues, 350-58.
 — charging, 441.
 Caretakers, 104.
 Carnegie, A., 20.
 Carr, H. J., 174.
 Carthusian monasteries, 432.
 Cash book, 44.
 — receipts book, 47.
 Catalogue, card, 350-58.
 — page, 345.
 — placard, 364.
 — printed, 332.
 — sheaf, 358-63.
 Cataloguing, rules, 328-31.
 — annotations, 330 (i-j), 330 (4), 331, 333-39.
 — classified *versus* dictionary, 326-31.
 — co-operative, 338.
 — display methods, 344-66.
 Certificate of exemption from payment of rates, 61.
 Chairs, 228-231.
 Chambers, G. F., 15, 87.
 Charging systems, apparatus, 337-40.
 — methods, 431-47.
 Checks on staff work, 96.
 Children's rooms and libraries, 491-96.
 Chivers, C., 405.
 — indicator, 212.
 Christie indicator, 206.
 Clamps for papers, 244.
 Clarke, A., 285.
 — E. E., 366.
 Class lists, 333.
 Classes, science, etc., 5, 150, 500.
 — of literature in libraries, 253.
 Classification, general principles, 305-10.
 — adjustable, 312.
 — decimal, 314.
 — expansive, 316.
 Cleaning of buildings, 133.
 Clegg, J., 87.
 Clerk of works, 123.
 Clips for papers, 245.

INDEX.

[The Numbers are those of Sections, not Pages.]

- Clocks for libraries, 173.
 Cloth binding, 398.
 Coe, E. M., 285.
 Cole, G. W., 468.
 Collections, local, 269.
 — special, 270.
 Colonial library legislation, 12.
 Colours for shelf and bookbinding,
 395; marking, 321.
 Commissions, illegal, 57.
 Committee room furnishing, 285.
 Committees, appointment, constitu-
 tion, delegation of powers, agen-
 das, etc., 22-32.
 Companies' Acts, 11.
 Congress, Library of, catalogue cards,
 340.
 Contracts, 53; building, 126.
 Co-operative cataloguing, 338.
 Copinger, W. A., 87.
 Copying press, 247.
 Corrupt Practices Act, 57.
 Cotgreave, A., 427.
 — indicator, 211.
 Cotton, H., 87.
 Counter routine, 446.
 Counters, 158.
 County libraries, 7, 455.
 Cousin, J., 87.
 Covers for books, 394.
 Cowell, P., 87, 109, 528.
 Crawford, E., 325.
 Credland, W. R., 15, 67.
 Croydon bindery, 391.
 Crunden, F. M., 32, 67.
 Cushing, W., 87.
 Cutler, M. S., 285, 331, 421, 463.
 Cutter, C. A., 87, 285, 316, 326, 328,
 329, 330 (6).
 — author marks, 319.
 — classification, 316.
 Cutting up books, 299.
 Cycle accommodation, 171.

 DANA, J. C., 87, 263, 285, 310, 379,
 421, 501.
 Davenport, C., 405.
 Davis, C. T., 67.
 Decimal classification, 314.
 Decoration of buildings, 138.
 Delegation of powers to committees,
 24.
 Delivery stations, 454.
 Dent, R. K., 285, 501.
 Dent indicator, 206.
 Deposits in lieu of guarantors, 419
 (16), 420 (16).
 Desks, 232-34.
 De Vinne, T., 87.
 Dewey classification, 314.
 — M., 87, 314, 323, 343.
 Dictionary catalogues, 326, etc.
 Discarding books, 277.
 Diseases, infectious, notification, 419
 (25), 420 (25), 421.
 District auditors, 52.
 Dixon, Z., 87.
 Dogs in libraries, 171.
 Donations, 286.
 Doren, E. C., 501.
 Doubleday, W. E., 285, 331, 524, 527.
 Doubtful books, 267.
 Dousman, M. E., 501.
 Dummies, shelf, 193, 324.
 Dunning, A. S., 87.
 Duplex card tray, 357.
 Duplicate borrowers' tickets, 419 (19),
 426.
 Duplicates of popular books, 264.
 Dusting, 170, 384.
 Duval, L. M., 421.
 Dyall indicator, 208.
 Dziatzko, C., 87, 323 (8).

EASERS, reading, 226-27.
 Edmond, J. P., 331.
 Educational authorities and libraries,
 9.
 Edwards, E., 87, 286, 310, 311, 527.
 — Passmore, 20.
 Electric lighting, 135.
 Elliot indicator, 207.
 End papers, 401.
 Endowments, 20.
 Enforcement of rules, 417.
 Engravings in libraries, 273.
 Estimate of expenditure, annual, 53.
 European library legislation, 14.
 Evaluation of books, 330-31.
 Examinations for assistants, 91-92.
 Exchanges between libraries, 458.
 Exhibitions, 499.
 Expansive classification, 316.

FAIRCHILD-ADAMS, 501.
 Faulmann, K., 87.
 Female librarians and assistants,
 107.

INDEX.

[The Numbers are those of Sections, not Pages.]

- Fiction in libraries, 259, 285.
 Filing apparatus, 241-46.
 — methods, 373.
 Finance, library, 33, 51, 53.
 Finding lists, 326, etc.
 Fines and penalties, 413 (5), 414, 421, 446.
 Finishing (bookbinding), 392-96.
 Fire extinguishing apparatus, 64.
 — places, 131.
 Fittings, 157-74.
 Fletcher, R. S., 285.
 — W. I., 87, 89, 285, 379.
 — W. J., 405.
 Flint, W., 87.
 Floors, 170.
 Folders for filing, 373.
 Foreign languages, books in, 270.
 Forms, 380.
 Fortescue, G. K., 87.
 Foster, J. E., 474.
 — W. E., 474, 527.
 Fountain pens, 381.
 Fovargue, H. W., 15, 21, 87.
 Furniture, 217-36.

GALLERIES, 189.
 Garnett, R., 87.
 Gas lighting, 136.
 Gissing, George, 137.
 Gould, I. C., 285.
 Graesel, A., 87, 109, 130, 310, 331, 405, 519.
 Graesse, J. G. T., 87.
 Grassauer, F., 87.
 Green, E., 463, 501.
 — H. E., 366.
 — R. R., 130.
 — S. S., 501, 527.
 Greenhough, W. H., 139.
 Greenwood, Thomas, 15, 18, 32, 43, 87, 107, 121, 123, 408, 421, 445, 468, 498, 501.
 Griswold, W. M., 87.
 Gross, C., 87, 284.
 Growth of libraries, 254.
 Guides, card catalogue, 350.
 — charging system, 239.
 Guild, R. A., 87.
 Guppy, H., 285, 331.

HAFFERKORN, H. E., 87, 284.
 Hain, L., 87.
 Halkett, S., 87.

 Handles for bookcases, 192.
 Hart, J. W., 139.
 Hartley, M. E., 285, 421.
 Hartwig, 311.
 Hasse, A. R., 87.
 Hat rails, 230.
 Hayward, A. L., 87.
 Heating of buildings, 131.
 Hewins, C. M., 109, 283, 501.
 Higginson, T. W., 527.
 Hill, F. P., 109.
 Holborn Library, card charging, 444.
 Holiday opening of libraries, 415.
 Holidays of staff, 99.
 Home binding, 390.
 Horne, T. H., 87.
 Hosmer, J. K., 109, 285, 527.
 Hours of libraries, 406.
 — of staff, 97.
 Humphreys, H. N., 87.
 Hutchins, F. A., 463.

ILES, G., 87, 284, 331.
 Imaginative literature in libraries, 259, 285.
 Improper books, 267.
 Income Tax Act, 60.
 Indexing, 330 (5), 367-72.
 Indicators, 201-16.
 Infectious diseases notification, 419 (25), 420 (25).
 Inks, 385.
 Insurance of libraries, 64.
 Inter-library exchanges,
 Inventory book, 383.
 Issue charging or registration, apparatus, 237-40.
 — methods, 431-47.
 — record book, 462.

JACOBI, C. T., 87.
 James, H. P., 109, 501.
 — M. S. R., 109.
 Jast, L. S., 304, 306, 310, 319, 321, 325, 328, 329, 331, 366, 370, 379, 396, 405, 501.
 Johnston, D. V. R., 405.
 — T., 421.
 Jones, G. M., 304, 427.
 — H., 32.
 Juvenile rooms, planning, 151; rules, 419 (84).
 — management, policy, 491-96.

INDEX.

[The Numbers are those of Sections, not Pages.]

- KENNEDY** indicator, 208.
 Kephart, H., 810.
 Keys, 888.
 Kimmins, C. W., 501.
 Kirkwood, Rev. J., 488.
 Kroeger, A. B., 87.
- LABEL** holders, 195.
 Labelling books, 298.
 Ladders, 190.
 Ladies' rooms, 152.
 Lady librarians and assistants, 107.
 Lambert's adjustable shelving, 180-81.
 Lancaster, A., 501.
 Lane, W. C., 881.
 Langlois, C. V., 87.
 Langton, H. H., 825.
 Larned, J. N., 87, 285.
 Lavatory accommodation, public, 147.
 Learned, W., 285.
 Leather binding, 394; reviving, 394.
 Lecture rooms, 154.
 Lectures, 498.
 Ledger account, 45.
 — charging, 494.
 Legality of rules, 417.
 Legislation required for libraries, 5.
 Lending department, accommodation, 145; rules, 419.
 — — books for, 268.
 Letter-copying press, 247.
 Letter filing, 373-75.
 Lettering and numbering books, 396.
 Leyden slip catalogue, 359.
 Leyboldt, A. H., 87, 288.
 Librarian: qualifications, duties, salaries, appointment, etc., 68-85; residence, 148; office, 284.
 — library of professional books, 87.
 Libraries Acts, municipal, 1-9.
 — co-operation with educational authorities, 9.
 — non-municipal, 10.
Library, 87.
 — *Assistant*, 87, 106.
 — Assistants' Association, 108.
 — Association conferences, 88 (5).
 — — cataloguing rules, 328.
 — — examinations, 92.
 — — *Record*, 87.
 — *Chronicle*, 87.
 — *Journal*, 87.
- Library World*, 87, 888-89, 400, 464.
 Lifts, 168.
 Lighting of buildings, 133.
 Linderfelt, K. A., 87, 328.
 Literary institutions, 10-11.
 — Societies Act, 60.
 Liverpool Library open access, 528.
 Loans, 36.
 Local collections, 269.
 Lord, I. E., 527.
 Lowndes, W. T., 87.
 Lyster, T. W., 806, 825.
- MACALISTER**, J. Y. W., 426, 427.
 Macfarlane, J., 87, 109.
 Maclauchlan, J., 208.
 Magazine, Library (bulletin), 336.
 — room accommodation, 148; rules, 419.
 — — management, 481.
 Magazines, sets of, 271.
 Maire, A., 87.
 Manchester P. L. (non-fining), 414.
 Manifolding apparatus, 250.
 Maps, 276, 376, 379.
 Marks on books, 321.
 Mathews, E. R. N., 109, 285.
 Mayor, J. B., 87, 284.
 Melville, H., 305.
 Metropolitan Borough Councils, 24, 25.
 Mill, H. R., 284.
 Miner, S. H., 427.
 Minto, J., 468.
 Minutes of committees, 27; index, 372.
 Mitchell Library, 20, 345, 378, 391.
 Monastic library book registration, 432.
 Montgomery, T. D., 527.
 Moore, H. K., 524, 527.
 Morgan indicator, 208, 210.
 Mortgages, register of, 89.
 Museum libraries, 110.
 Museums, 5, 150, 500.
 Music in libraries, 272.
- NEWSPAPERS**: stands, 168; fittings, 165; filing cases, 185; filing method, 378; "blacking-out," 478.
 Newsroom, details of accommodation, 144; rules, 419.
 — management and policy, 475-80.

INDEX.

[The Numbers are those of Sections, not Pages.]

- Nichols, J. B., 379.
 Nocturnal conclave, 271, 285.
 Notation for books and shelves, 320-22.
 Novels in libraries, 259, 285.
 Number books, 294-95.
 Numbering and lettering books, 396.
 Numbers for books, 318.
- OFFICE** work, 33-67.
 Ogle, J. J., 15, 87, 109, 501.
 Open access, arguments against, 519-25.
 — — barriers, 159-60.
 — — book and shelf marking, 320-22.
 — — charging system, 462, 472.
 — — policy, etc., 502-27.
 — — reference, 142, 467-68.
 Opening ceremonies, 129.
 Ordering books, 292.
 Orderly board, 96.
 Out-of-print books, 265.
 Overdues, 207, 431-446 *passim*.
- PACY**, F., 67.
 Page catalogues, 345.
 Pamphlets, 303, 377, 379.
 Panoramic catalogues, 365.
 Panzer, G. W., 87.
 Parliamentary papers, 236.
 Parsons, F. H., 235.
 Patton, N. S., 139.
 Pegamoid, 398.
 Pen rack, 381.
 Pencils, 381.
 Pennock, B. W., 447.
 Pens, 381.
 Penzance Library, card charging, 444.
 Percentage of classes in libraries, 268.
 Periodical covers, 403.
 — filing, 378, 435-88.
 — holder, 166.
 — indicators, 215.
 — racks and tables, 221-25.
 Periodicals, arrangement for public use, 431.
 — checks on deliveries, 435.
 Perkins, F. B., 87, 283, 311, 328.
 Petty cash book, 46.
 Petzholdt, J., 87, 310.
 Photographs in libraries, 274.
 Pipe-stalking for books, 184.
- Pite, B., 130.
 Placard catalogue, 364.
 Plans, library, 119-25.
 Plomer, H. R., 87, 285.
 Plummer, M. W., 87, 440, 447, 501.
 Pollard, A. W., 87, 331.
 Poole, R. B., 67, 405.
 — W. F., 87, 439, 522.
 Popular books in duplicate, 264.
 Portfolios, 243.
 Portsmouth bindery, 390.
 Postage book, 48.
 Power, J., 87.
 Prideaux, S. T., 87.
 Printing outfits, 249.
 — specifications, 342.
 Prints, 269, 273, 376.
 Proctor, R., 87.
 Propositions of books, 289.
 Public and staff, 106.
 — Bodies Corrupt Practices Act, 57.
 — documents, 236.
 "Public libraries," 87.
 Public Libraries Acts, 1, 2.
 — rules and bye-laws, 419-34.
 Putnam, H., 527.
- QUÉBARD**, J. M., 87.
 Quinn, J. H., 87, 328, 329, 330 (6), 331, 342.
- RACKS** for filing, 188.
 — for periodicals, 221-25.
 Rate, library, 4 (c), 33.
 — — limitation, 6, *et passim*.
 Ratepayers' voucher forms, 422.
 Rates, exemption, 60-63.
 Rawson, H., 32.
 Readers' tickets, 413 (1).
 Reading easels, 226-27.
 — tables, 120-21.
 Records, local, 269 (8).
 Reference libraries, 464-74.
 — library, details of planning, 141 ;
 rules, 419.
 — — books, 268.
 Refreshment rooms, 155.
 Registrar of friendly societies, certificate of exemption, 61.
 Regulations, public, 419-34.
 Remembrancer for librarians, 86.
 Renewal of borrowed books, 419 (21), 420 (21).
 Repairing books, 391.

INDEX.

[The Numbers are those of Sections, not Pages.]

- Replacements of books, 265.
 Report of committee, annual, 66.
 Requisitions for supplies, 59.
 Reserving books, 419 (23), 420 (23).
 Residences for librarians and care-takers, 148.
 Reyer, E., 87.
 Richardson, E. C., 87, 285, 310, 311.
 Riddell, R., 481.
 Roberts, H. D., 109, 501.
 Rogers, W. T., 87.
 Routine book, 294.
 Rouveyre, E., 87.
 Rudolph continuous indexer, 365.
 — indexer, 348.
 Rules and regulations, 419-21.
 Rural libraries, 7.
- SACCONI sheaf catalogue, 361, 366.
 Safe-guarded open access, barriers, 159-60, 502-27.
 Salaries, librarian, 76.
 — staff, 100-02.
 — payment of, 49.
 Sanders, M. A., 501.
 Sargent, E. B., 87, 283.
 — I. F., 87.
 Savage, E. A., 304, 331, 501.
 Schools and libraries, 4 (d), 9, 10-11, 491-96.
 — of science, 5, 150, 500.
 Schwartz card charging, 443.
 Scientific institutions, 10-11.
 — Societies Act, 60.
 Scotland, Libraries Acts, 1.
 Scrapbooks (Bardwell), 379.
 Screens, 162.
 Selection of books, 251-85.
 Sharp, K. L., 87.
 Sheaf catalogues, 358-63.
 Shelf dummies, 193; guides, 196; handles, 192; register, 323; steps, 190-92.
 — marking, 321-22.
 Shelving, 175-88.
 Shepherd, J., 285.
 Showcases for books, 216.
 Simplex newspaper rod, 166.
 Sites, library, 117.
 Size notation, 324, 325.
 Slater, J. H., 87.
 Slip book catalogues, 358-63.
 — charging, 439.
 Smith, L. P., 87, 109, 311.
- Smith's adjustable shelving, 183.
 Solberg, T., 15.
 Sonnenschein, W. S., 87, 283, 311.
 Soule, C. C., 32.
 Speaking tubes, 169.
 Special collections, 270.
 Staderini card tray, 356.
 — slip catalogue, 360.
 Staff accommodation, 146, 286.
 — salaries, grades, appointments, 90-103.
 Stamping of books, 299, 402.
 State papers, 286.
 Stationery, 380-82.
 — office grants, 286.
 Statistics, 459.
 Statutes, 1-11.
 Stein, H., 87, 283.
 Steiner, B., 285, 527.
 Stephens, J. A., 331.
 Steps, 190-92.
 Stevenson, R., 405.
 Stock book, 300.
 Store room, 149.
 Straight, M. W., 405.
 Strong room, 149.
 Students' accommodation, 141.
 — rooms, 153.
 — tickets, 419 (19), 426.
 Sturgis, R., 284.
 Stylographic pens, 381.
 Sub-librarian, 103.
 Subscription books, 291.
 — for library books, 419 (18), 420 (18).
 — departments, 456.
 Suggestions on management, 65.
 Sunday opening of libraries, 416.
 Supplies, indexing, 370-71.
 Swan, R. T., 385.
 Swann, J. H., 809.
- TABLES, 219-20.
 Taxes, assessment to, 60.
 Technical libraries, 11, 497.
 Tedder, H. R., 109.
 Teggart, F. J., 527.
 Telephones, 169.
 Temple, A. G., 501.
 Thermometers in libraries, 173.
 Thompson, W. O., 87.
 Thomson, J., 463, 527.
 Tickets for borrowers, 425-29.
 Tier marking of books, 321.

INDEX.

[The Numbers are those of Sections, not Pages.]

- Time book, 94.
 Time limits for borrowing, 413 (8).
 — sheet, 98.
 Travelling libraries, 455.
 Trays, cards, 350-57.
 — charging, 237-40.
 Truck for books, 200.
 Turner, F., 285, 331.
 Turnstiles, 172.
 Typewriters, 248.
- UNITED States libraries, *passim*.
 — — library legislation, 13.
 — — — juvenile rooms, 492.
 Utley, H. M., 32, 130, 285.
- VALLÉE, L., 87.
 Vaseline for leathers, 394.
 Ventilation, 137.
 Village libraries, 7, 455.
 Virgo card charging, 442.
 Visits of committees to library, 31.
 Voucher forms, 422.
- WAGES book, 49.
- Waite, J. K., 463.
 Wallets for filing, 247.
 Watt, R., 87.
 Welch, C., 109.
 Wheatley, H. B., 87, 328.
 Whitney, I. L., 87.
 Willcock, W. J., 304, 331, 421.
 Willcox, E. S., 521, 527.
 Wilson, R. E., 463.
 Winks, W. E., 501.
 Withdrawals book, 303.
 Women librarians and assistants
 107, 109.
 Women's rooms, 154, 490.
 Wood, B., 285, 474, 501.
 Woodard, G. E., 405.
 Woodruff, E. H., 285, 474.
 Work book, 94.
 — room, 149.
 Workshop libraries, 110-12, 251-57,
 277.
 Worn-out books, 265.
 Writing materials, 331.
- ZAHNSDORF, J., 405.

EDWARD EDWARDS,

THE CHIEF PIONEER OF

MUNICIPAL PUBLIC LIBRARIES.

BY

THOMAS GREENWOOD.

Crown 8vo. xii+246 Pages. 1902. Gilt Top. Price 2s. 6d. net.

CONTENTS.

- CHAPTER I.—Introductory.
CHAPTER II.—Some Biographical Details, and his Place in the Public Library Movement.
CHAPTER III.—Early Pamphlets on Library and Educational Questions, and his Evidence before the Parliamentary Committee on the British Museum of 1836.
CHAPTER IV.—Work at the British Museum 1839-1850, and his Advocacy of Public Libraries in 1847 and 1848.
CHAPTER V.—Digest of the Evidence of Edwards before the Parliamentary Committees of 1849 and 1850.
CHAPTER VI.—Work at Manchester, 1851-1858.
CHAPTER VII.—Edwards and Present-day Librarianship.
CHAPTER VIII.—His Literary and other Work.
CHAPTER IX.—The Homely Side, and Life among his Books.
CHAPTER X.—His Mother and Sisters at Manningtree.
CHAPTER XI.—Last Years and Death.

APPENDICES.

- " . . . A very painstaking and lucid biography."—*Morning Leader*.
" The summaries of his writings . . . are full of interest "—*Spectator*.
" . . . Sympathetically, graphically, yet critically drawn."—*Worthing Observer*.
" Bookmen should read this book with interest and gratitude."—*The Bookman*.
" The story of his life's work ably told . . . is of great interest."—*Northampton Reporter*.
" He has fulfilled a kindly office in a kindly and sympathetic spirit."—*Sheffield Telegraph*.
" It is a notable tribute to one of the benefactors of humanity. . . ."—*Liverpool Courier*.
" We heartily recommend the volume . . . which is remarkably interesting."—*Church Bell*.
" Librarians—and many others—will be grateful to . . . for his excellent biography."—*Daily Chronicle*.
" . . . In this unpretentious but factual volume the story of his life and service is fitly told."—*Aberdeen Free Press*.
" The telling facts of Edwards' career in all the relations of his life are seized upon, with reverent but discriminating regard. . . ."—*East Anglian Times*.
" The life-story . . . was well worth the telling, and such a life of public usefulness deserved the memorial Mr. Greenwood has lovingly given it."—*Black and White*.
" It ought to win gratitude and evoke the interest of every person who . . . enjoys the comfort and the delight of free access to books in these institutions."—*Irish Times*.
" . . . A memoir which will go far to secure to the apostle of free libraries the fame that is due to his able and persistent labours on behalf of a great public object."—*Daily News*.
" Mr. Greenwood's own enthusiasm for public libraries is well known, and, as might have been expected, much interesting matter concerning the movement is to be found in his book."—*Literary World*.

PUBLISHED BY

SCOTT, GREENWOOD AND CO.,

19 LUDGATE HILL, LONDON, E.C.

AND TO BE HAD THROUGH ALL BOOKSELLERS.

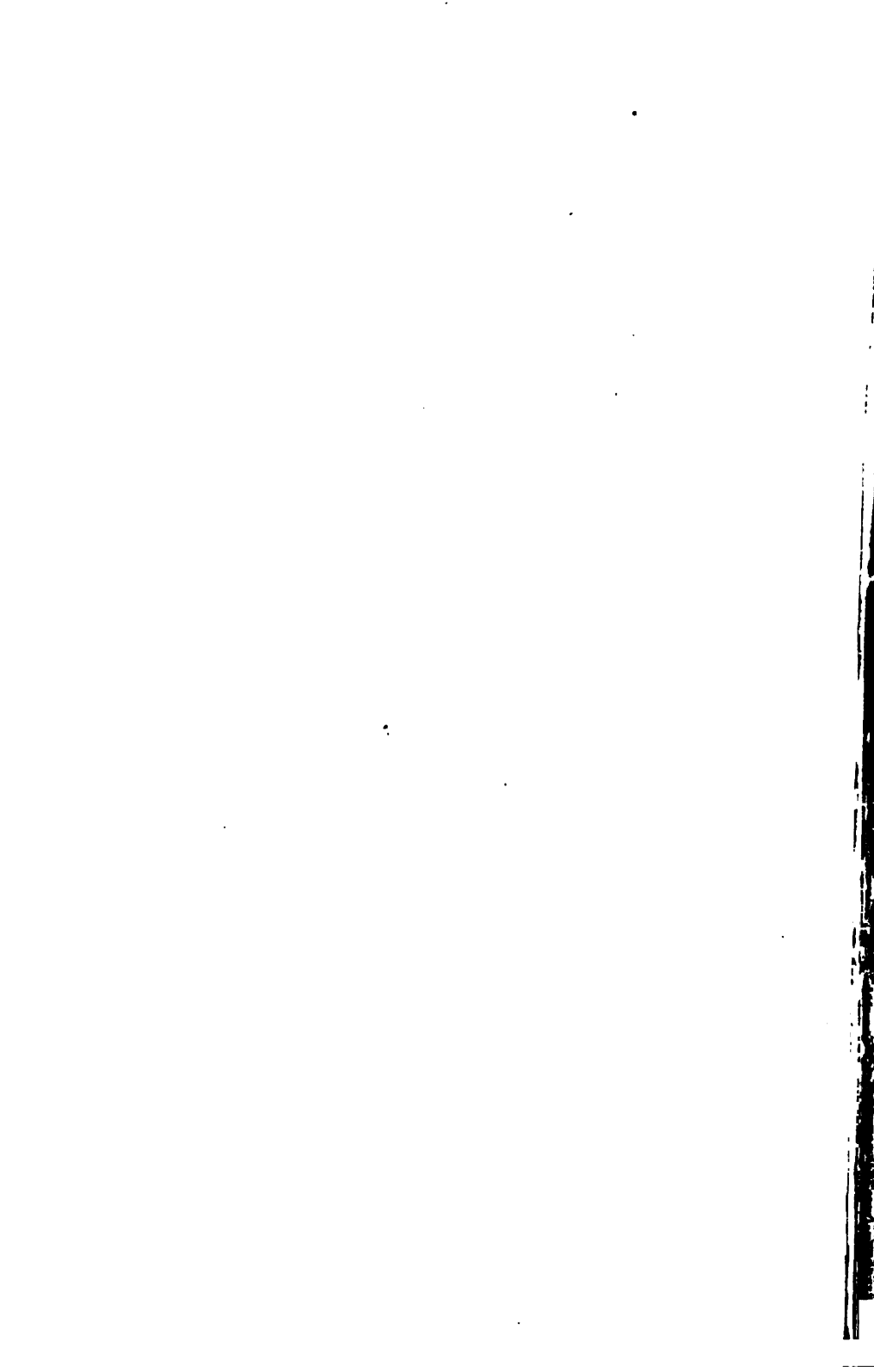

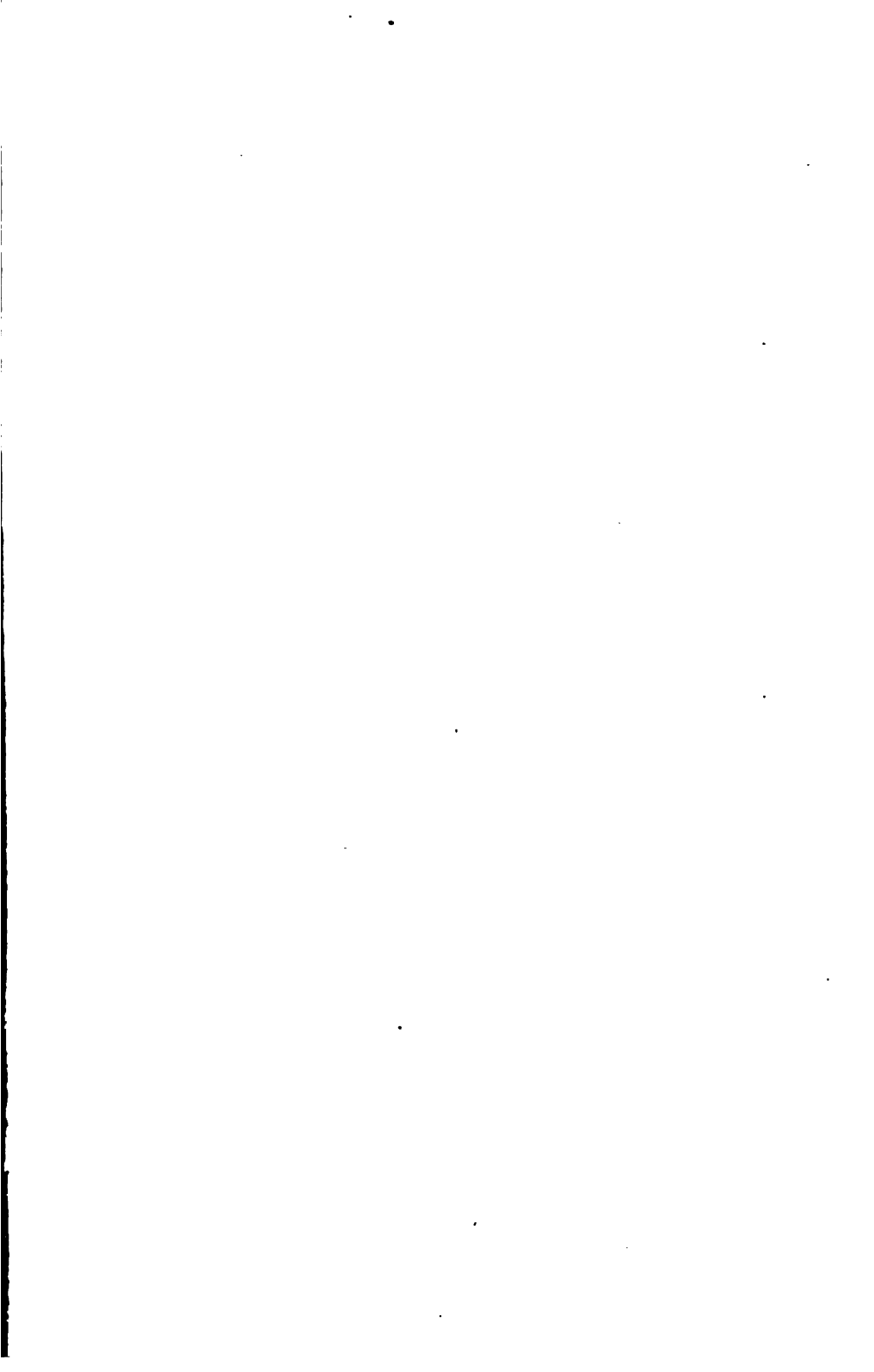

RETURN TO the circulation desk of any
University of California Library
or to the

NORTHERN REGIONAL LIBRARY FACILITY
Bldg. 400, Richmond Field Station
University of California
Richmond, CA 94804-4698

ALL BOOKS MAY BE RECALLED AFTER 7 DAYS
2-month loans may be renewed by calling
(510) 642-6753

1-year loans may be recharged by bringing books
to NRLF

Renewals and recharges may be made 4 days
prior to due date

DUE AS STAMPED BELOW

FEB 8 1995

SENT ON ILL

SEP 23 1998

U. C. BERKELEY

JUL 26 2000

YC 90506

